

PART NO. 599910644

SERVICE MANUAL  
CRT DISPLAY  
DPro2070SB / DPro2070SB-BK  
(C22BW711)  
Southern Hemisphere Version

The First Edition

NEC-MITSUBISHI ELECTRIC VISUAL SYSTEMS CORPORATION

FEBRUARY 2003

## Contents

1. Circuit description .....	1-1
1.1 Power block .....	1-1
1.1.1 Outline .....	1-1
1.1.2 Rectifying circuit and higher harmonics suppression (active filter) circuit .....	1-1
1.1.3 Sub power circuit .....	1-2
1.1.4 Main power circuit .....	1-2
1.1.5 Demagnetizing circuit .....	1-2
1.1.6 Power management circuit .....	1-2
1.2 Deflection processor block .....	1-3
1.2.1 Deflection processor (IC601) .....	1-3
1.2.2 Pressure-reduction type horizontal deflection power circuit (IC5C0) .....	1-3
1.2.3 Horizontal width control circuit .....	1-3
1.2.4 Vertical deflection circuit .....	1-3
1.2.4.1 Sawtooth waveform generation, vertical size/position control, and linearity control circuit .....	1-3
1.2.4.2 Vertical output amplification circuit .....	1-4
1.2.5 High voltage block .....	1-4
1.2.6 DBF (Dynamic Beam Focus) circuit .....	1-5
1.3 Video block .....	1-6
1.3.1 Video signal amplifier circuit .....	1-6
1.3.1.1 Video clamp .....	1-6
1.3.1.2 Video blanking .....	1-6
1.3.1.3 Video mixing/amplifying .....	1-6
1.3.1.4 Control of contrast and white balance .....	1-6
1.3.2 Cut-off control circuit .....	1-7
1.3.2.1 Control of brightness .....	1-7
1.3.2.2 Control of BIAS .....	1-7
1.3.3 OSM (On Screen Manager) .....	1-7
1.3.4 2 Input change circuit .....	1-8
1.3.5 Sync on Green circuit .....	1-8
1.3.6 Asset circuit .....	1-8
1.3.7 AUTO-SIZE function .....	1-8
1.3.8 SB MODE (Super Bright Mode) function .....	1-8
1.3.8.1 Adjustment item/operating function in selecting SB Mode .....	1-8
1.3.8.2 Circuit (cathode) operation in selecting SB Mode [Window pattern] ....	1-9
1.3.8.3 SB Mode setting data and control method .....	1-9
1.3.9 CONSTANT BRIGHTNESS function .....	1-10

1.4 CRT compensation block .....	1-10
1.4.1 Earth magnetism cancel circuit.....	1-10
1.4.2 Rotation circuit .....	1-11
1.4.3 East-west horizontal magnetic field vertical position canceling function .....	1-11
1.4.4 Corner purity circuit .....	1-11
1.4.4.1 Corner purity circuit operation.....	1-12
1.4.5 Vertical magnetic field landing cancel circuit .....	1-12
1.4.6 Digital dynamic convergence clear (DDCC) circuit .....	1-12
1.4.6.1 Production of compensation current waveform .....	1-13
1.4.6.2 Waveform, and operation on the picture .....	1-13
1.4.6.3 Adjustment method .....	1-14
1.4.6.4 Block diagram .....	1-14
1.4.7 East-west horizontal convergence canceling function .....	1-19
1.5 USB circuit.....	1-19
1.5.1 Outline .....	1-19
1.5.2 USB downstream power supply .....	1-19
1.5.3 HUB controller power output .....	1-19
1.5.4 USB power on reset .....	1-19
1.6 Control block .....	1-20
1.6.1 Function of control circuit .....	1-20
1.6.2 Auto-tracking process .....	1-20
1.6.3 EEPROM .....	1-20
1.6.4 On-Screen-Manager (OSM) controller.....	1-20
1.6.5 Heater voltage control .....	1-20
1.6.6 Protection circuit operation .....	1-20
1.6.6.1 X-ray protector .....	1-20
1.6.6.2 High voltage data error detection .....	1-21
1.6.6.3 Beam current protector .....	1-21
1.6.6.4 Power-On Indicator (LED) flickering pattern in each protector operating .....	1-21
1.6.6.5 Operating time .....	1-21
1.6.6.6 The DDC communication .....	1-21
1.6.6.7 Microcomputer pin assignment .....	1-22
1.7 X-ray protection circuit and safety protection circuit .....	1-23
1.7.1 X-ray protection circuit .....	1-23
1.7.2 Beam current protection circuit.....	1-23
1.7.3 IC701 overcurrent protection circuit .....	1-23
1.7.4 IC701 overload protection circuit .....	1-23
1.7.5 IC902 overcurrent protection circuit .....	1-23

1.7.6	Short-circuit protection circuit on secondary power side .....	1-23
1.7.7	Overvoltage protection circuit .....	1-23
1.8	Adjustment .....	1-24
1.8.1	Adjustment mode .....	1-24
1.8.2	User mode (Normal mode) .....	1-24
1.8.3	Factory mode .....	1-27
1.8.3.1	How to entering to Factory mode .....	1-27
1.8.3.2	How to cancel Factory mode .....	1-27
1.8.3.3	How to enter FACTORY-HV mode .....	1-27
2.	Adjustment procedure .....	2-1
2.1	Measuring instruments .....	2-1
2.2	Preparatory inspections .....	2-1
2.3	Names of each monitor part .....	2-2
2.3.1	Configuration of front control panel .....	2-2
2.3.2	Configuration of rear input connector (signal input) .....	2-2
2.3.3	OSM display matrix .....	2-3
2.3.3.1	User mode .....	2-3
2.3.3.2	Factory mode .....	2-4
2.4	Adjustment .....	2-7
2.4.1	How to select the factory adjustment (FACTORY) mode .....	2-7
2.4.1.1	Selecting with front panel switches .....	2-7
2.4.2	Adjustments before aging .....	2-7
2.4.2.1	Adjusting the high voltage and high voltage protector .....	2-7
2.4.2.2	FOCUS adjustment (Rough adjustment) .....	2-8
2.4.2.3	Shock test .....	2-8
2.4.2.4	Preadjustment before aging .....	2-8
2.4.2.5	Adjusting the landing (ITC/4 corner purity adjustment) .....	2-9
2.4.3	Adjusting the picture size, position and distortion, DBF amplitude and phase .....	2-9
2.4.3.1	Adjusting the picture inclination .....	2-9
2.4.3.2	Adjusting the back raster position .....	2-9
2.4.3.3	Adjusting the left/right distortion, picture width, picture position (LEFT/ RIGHT) and vertical linearity (all preset) .....	2-10
2.4.3.4	Adjusting the DBF amplitude and phase .....	2-10
2.4.4	Adjusting the cut off .....	2-11
2.4.4.1	Adjusting BTCEN (BRIGHT-CENT), BTMAX (BRIGHT-MAX) and BS1 (BIAS-H) .....	2-11
2.4.4.2	Adjusting BS2 (BIAS-M) / BS3 (BIAS-L) .....	2-12
2.4.5	Setting CONSTANT BRIGHTNESS circuit (Factory mode) .....	2-13
2.4.5.1	Reading beam current default data .....	2-13
2.4.5.2	Confirming CONSTANT BRIGHTNESS function .....	2-13

2.4.6	Adjusting the RGB drive signal .....	2-13
2.4.6.1	Adjusting GN1 (GAIN-H) (adjustment of 9300K) .....	2-13
2.4.6.2	Adjusting ABL .....	2-15
2.4.7	Adjusting the focus .....	2-15
2.4.8	Adjusting the convergence .....	2-16
2.4.8.1	Adjusting with ITC .....	2-16
2.4.8.2	Adjusting DDCP .....	2-18
2.4.9	Default settings (With factory mode) .....	2-23
2.5	Inspections (In normal mode) .....	2-24
2.5.1	Electrical performance .....	2-24
2.5.1.1	Withstand voltage .....	2-24
2.5.1.2	Grounding conductivity check .....	2-24
2.5.1.3	Degaussing coil operation .....	2-24
2.5.1.4	IPM OFF MODE function operation (Set the AC power input to 230V) .....	2-24
2.5.1.5	Confirming the GLOBAL SYNC (CORNER-Purity) function .....	2-25
2.5.1.6	Focus, picture performance .....	2-25
2.5.1.7	Misconvergence .....	2-25
2.5.1.8	Picture distortion .....	2-26
2.5.1.9	Linearity .....	2-28
2.5.1.10	Adjustment value list .....	2-29
2.5.1.11	Confirming EDGELOCK and SYNC GREEN .....	2-30
2.5.1.12	Checking the functions during Composite Sync input .....	2-30
2.5.1.13	Confirming the reset operation .....	2-30
2.5.1.14	Confirming the full white luminance/color coordination .....	2-30
2.5.1.15	Confirming CONVERGENCE compensation function .....	2-30
2.5.1.16	Confirming ROTATION compensation function .....	2-31
2.5.1.17	Luminance/color coordination uniformity .....	2-31
2.5.1.18	Confirming the color tracking .....	2-31
2.5.1.19	CRT installation position .....	2-31
2.5.1.20	Confirming SB MODE operation .....	2-31
2.5.1.21	Confirming AUTO-ADJUST operation .....	2-32
2.5.1.22	Confirming USB .....	2-32
2.5.1.23	Others .....	2-32
2.6	DDC function, check of asset management .....	2-33
2.6.1	DDC write data contents .....	2-34
2.6.2	Self-diagnosis shipment setting .....	2-35
2.7	Default inspection .....	2-35
2.7.1	Default setting of switches .....	2-35
2.7.2	Default setting of OSM .....	2-35
2.7.3	Checking the labels .....	2-35

2.7.4 Packaging .....	2-35
2.8 Degaussing with handy-demagnetizer .....	2-36
2.8.1 General precautions .....	2-36
2.8.2 How to hold and use the handy-demagnetizer .....	2-36
2.9 Caution .....	2-36
2.10 Timing chart .....	2-37
2.11 Adjustment timing .....	2-38

3. Trouble shooting
4. Wave form
5. Schematic diagram
6. Removal instruction sheet
7. Exploded view / Packing view

<Appendix>

- Serial number information
- Specification
- User's guide
- All parts list

# 1. Circuit description

## 1. 1 Power block

### 1.1.1 Outline

The power block is compatible with the business electric power, 100 to 120VAC/220 to 240VAC (50/60Hz). The active filter circuit is adopted to suppress the higher harmonic current. The circuit block is composed of two switching regulators, the main power which is the configuration used the flyback converter system of pseudo resonance operation and the sub power which is the configuration used PWM (pulse wise modulation) system. The output on the secondary side is shown in Table 1.

Power block	Output voltage	Mai load
Main power side	+215V	H. deflection circuit, Cut-off circuit
	+80V	Video circuit, DBF circuit, High voltage circuit
	+15V	H. deflection circuit, Rotation circuit
	-15V	Convergence circuit, Corner purity circuit
	+12V	Video circuit, H. deflection circuit
	+8V	Heater
Sub power side	+5V	Microcomputer (MPU)
	P-OFF+5V	VIDEO circuit

Table 1

### 1.1.2 Rectifying circuit and higher harmonics suppression (active filter) circuit

The AC input voltage is rectified in the full wave mode with the diode bridge in D901 and input to pin 5 of L903. The voltage of both end of C911 is the DC voltage approx. 390VDC boosted with the booster circuit (active filter circuit) composed of IC901, Q901, L903 and D902. The active filter circuit compares the voltage input to pin 1, pin 3 and pin 4 of IC901 and controls Q901 ON/OFF period so that the current flows to L903 be sine-waved. The AC input current is sine-waved in the same phase with the input voltage so as to improve the power factor, and the harmonic current is controlled consequently.

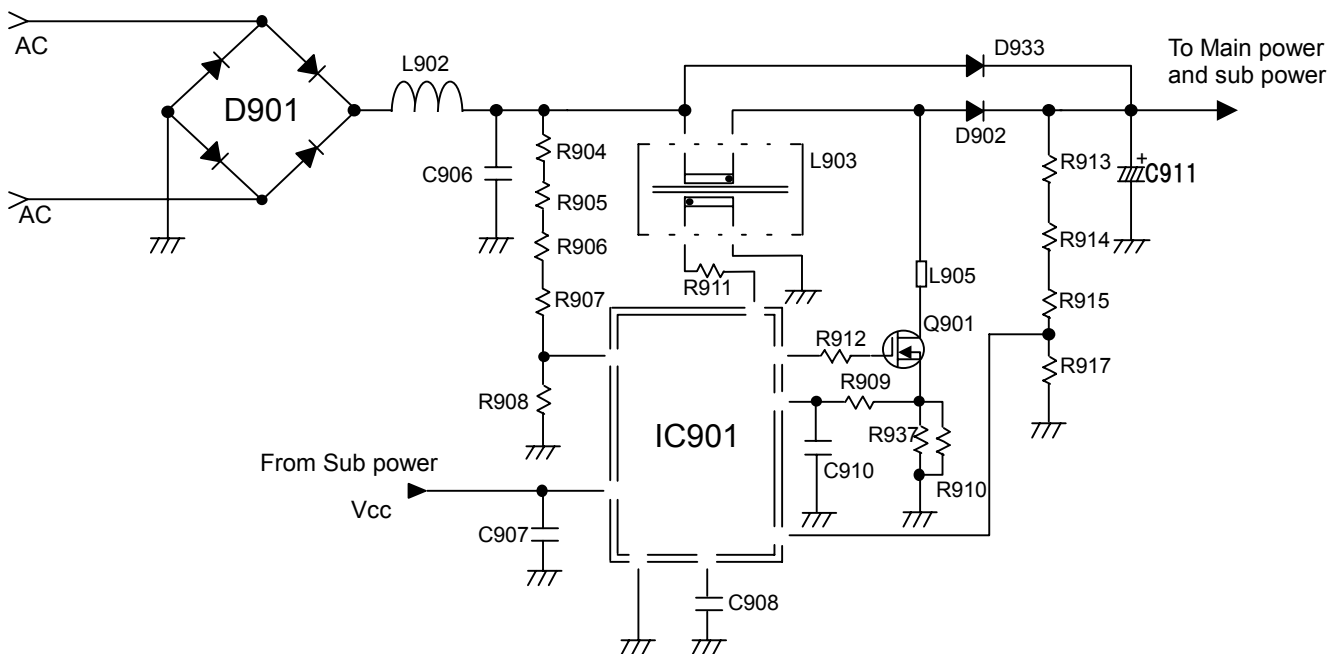

Fig. 1

### 1.1.3 Sub power circuit

When the power switch is turned ON, the rectified and smoothed DC voltage (AC voltage x 2) is supplied to pin 5 of IC903, and is charged to C930 through pin 1. When pin 1 reaches 5.7V, oscillation is started in IC903, and the built-in output FET is put into operation to add the pulse voltage between pin 5 and pin 3 on the primary side of T902. The flyback voltage in proportion to the voltage on the primary side is generated on the secondary side, then the DC voltage is generated with the half-wave rectifier circuit composed of D971 and C971. The DC voltage generated at the secondary side is monitored by IC922 through R976, R977 and R978. This information detected at IC922 is fed back to pin 1 of IC903 via PC902, and the ON period of output FET internal IC903 is controlled to keep the DC voltage on the secondary side constantly. The flyback voltage in proportion to the voltage on the primary side is also generated at pin 2 of T902. The pulse voltage generated at pin 2 of T902 is converted to the DC voltage at D932 and C931, and supplied to pin 8 of IC901 and pin 4 of IC902 via Q902.

### 1.1.4 Main power circuit

When the P-SUS signal from microcomputer is turned to HI, Q902 is turned to ON, and the voltage approx. +18V is supplied to pin 4 (Vcc terminal) of IC902 from pin 2 of T902.

When the voltage of pin 4 of IC902 reaches approx. +16V, oscillation is started in the circuit, and the built-in output FET is put into operation to add the pulse voltage between pin 5 and pin 2 on the primary side of T901. The flyback voltage generated at the secondary side in proportion to the one in the primary side is rectified at D961, D963, D964, D965 and D967 and smoothed at C961, C963, C964, C965 and C969 to generate the DC voltage. The DC voltage generated at the secondary side is monitored by IC921 through R960, R961, R962 and R985. The information detected at IC921 is fed back to pin 1 of IC902 via PC901, and the ON period of output FET internal IC902 is controlled to keep the DC voltage on the secondary side constantly.

### 1.1.5 Demagnetizing circuit

When the power is turned ON or the manual demagnetizing function on OSM menu is set to ON, pin 47 of IC102 on the main board is turned to HI, and Q950 and RL901 are also turned ON.

When RL901 is turned ON, the current flows to the demagnetizing coil, however, the demagnetizing current gradually converges with the fever of TH902.

### 1.1.6 Power management circuit

This monitor carries the power management function. This function is effective only when being connected with the personal computer carrying the power management function.

Mode	H-SYNC	V-SYNC	State	Display
NORMAL	ON	ON	Displaying a picture	Displaying a picture
SUSPENSION	OFF	ON	No picture	No raster
	ON	OFF	CRT heater is	
	OFF	OFF	decreased voltage mode (approx. 1.5V)	

The power consumption and the indication of Power-On Indicator for each mode are as follows.

Mode	Power consumption	Power-On Indicator
NORMAL	135W	Green
SUSPEND	3W or less	Orange

The control signal executes the power management function is output from microcomputer IC102. The control signal is composed of two signals, SUSPEND and P-OFF. The operating state of each signal is as follows.

Control signal name	Pin of IC102	Normal	Suspension
SUSPEND	Pin 5	H	L
P-OFF	Pin 42	H	L



## **1.2 Deflection processor block**

### **1.2.1 Deflection processor (IC601)**

Deflection processor IC601 horizontally compensates wise, position and distortion, and vertically controls heights, position and linearity.

IC601 automatically tracks the frequency to output the appropriate horizontal/vertical drive pulse.

IC601 also outputs the horizontal parabola waveform for focus and the waveform for convergence compensation.

### **1.2.2 Pressure-reduction type horizontal deflection power circuit (IC5C0)**

IC5C0 compares the parabola waveform output from pin 64 of IC601 (this waveform controls the horizontal width and distortion) with the sawtooth waveform (this waveform is synchronized with the horizontal frequency) in order to output the +B drive pulse. The +B drive pulse output from pin 9 of IC5C0 will accumulate the 215V energy in T550 during Q5F1 ON period. During Q5F1 OFF period, the accumulated energy will be released, and integrated by T550 and the S-shaped compensation capacitor.

The duty of this drive pulse depends on the DC level of the parabola waveform that is output from IC601.

### **1.2.3 Horizontal width control circuit**

Q550 is controlled by the horizontal drive pulse that is output from IC601. When Q550 is ON, the energy will be accumulated in the horizontal deflection yoke. When Q550 is OFF, the energy will flow into C550. While repeating this operation, horizontal deflection will be carried out.

The collector pulse of Q550 will be subject to voltage division by C590 and C591, and the voltage-divided pulse will be used for switching synchronization of the high-voltage control IC701 and also used as the AFC pulse.

The duty of the +B drive pulse output from pin 9 of IC5C0 will be subject to change in order to control the horizontal width. The parabola waveform output from IC601 is compared with the feedback waveform output from T5C0 to obtain the comparison waveform, and this comparison waveform threshes the sawtooth waveform inside IC5C0 in order to control the duty. If the duty is changed, the rectified voltage of the S-shaped compensation capacitor will be changed, and the horizontal width will be also changed. The vertical parabola waveform is generated inside IC601, and then mixed with the DC level for horizontal width control. After that, the mixed parabola waveform will be output from 64 pin of IC601, and added to IC5C0. This parabola output will be used for compensation of pin-cushion distortion, barrel distortion, trapezoidal distortion, and upper/lower distortion.

### **1.2.4 Vertical deflection circuit**

#### **1.2.4.1 Sawtooth waveform generation, vertical size/position control, and linearity control circuit**

If the vertical synchronization signal is input to 42 pin of IC601, the bipolar sawtooth waveform having the same frequency as the input will be output from pins 1 and 11 of IC601. IC601 receives compensation data from the MPU (IC102) to compensate the vertical size, vertical position, vertical raster position, vertical linearity, and vertical linearity balance, and then outputs the compensated sawtooth waveforms from pins 1 and 11. Pin 2 outputs the voltage to show the vertical deflection intermediate point.

The OP amplifier at the next stage outputs a signal to show the difference of the bipolar sawtooth waveform. For this output, the RC low pass filter is adopted to eliminate the digital gradation of the output waveform. In addition, pins 62 and 63 of IC601 will be turned ON during retracing operation in order to prevent deterioration of the linearity and dispersion of scanning lines. Moreover, Q603 and Q604 are switched depending on the vertical frequency in order to improve the linearity.

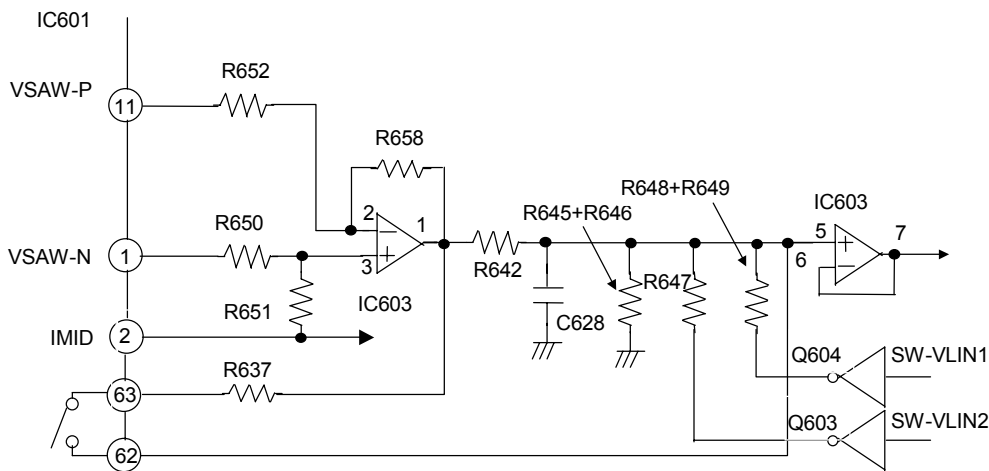

Fig. 2 Vertical sawtooth waveform output circuit

### 1.2.4.2 Vertical output amplification circuit

A current proportional to the waveform of the voltage input to IC401 will flow to the vertical deflection coil (V-DY). R410 reads out the voltage waveform of the vertical deflection current, and then feeds back it to IC401.

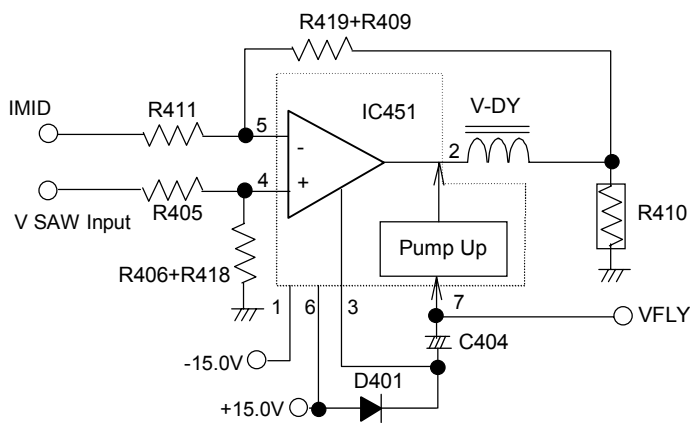

Fig. 3 Vertical output amplifier circuit

### 1.2.5 High voltage block

The high voltage block applies PWM control system that controls ON/OFF time of the high voltage generation FET.

IC701 is the control IC that executes PWM control. The pulse voltage generated at Q701 is boosted at T701 (FBT) to generate 27kV. To keep the high voltage stably, the feedback voltage from pin 10 of T701 is adopted, the control voltage from pin 56 of microcomputer IC102 is returned to pin 5 of IC701 and the pulse wise of PWM output is controlled. PWM synchronizes with the horizontal frequency. Trigger pulse for synchronizing is output from the divided collector pulse of the horizontal deflection output TR Q550, and is input to pin 8 of IC701.

For adjustment of high voltage value, the voltage of pin 56 of IC102 is adjusted with the adjustment item HV-ADJ-CAUTION on the OSM menu.

### 1.2.6 DBF (Dynamic Beam Focus) circuit

The horizontal/vertical DBF voltage is respectively generated and amplified, then synthesized at T7A1. As for the horizontal DBF voltage waveform, the parabola waveform voltage (approx. 0.5Vp-p) is output with IC601, and amplified about 10 times with OP-AMP IC6A2. After that, it is amplified to 50-60Vp-p with Q7B5 (the amplification factor is about 10 times), then it is amplified about 10 times with T7A1. On the other hand, as for the vertical DBF voltage waveform, the parabola waveform voltage (approx. 1.0Vp-p) is output from IC601. It is amplified about 40 times at Q7A1, and the vertical parabola wave is superposed to the horizontal parabola wave on the secondary side of T7A1, then consequently synthesized. The collector pulse voltage of the high voltage output TR (Q701) rectified at D7A1 and C7A1 is used for the power source of Q7A1. The synthesized DBF waveform is input to pin 12 of T701.

## 1.3 Video block

### 1.3.1 Video signal amplifier circuit

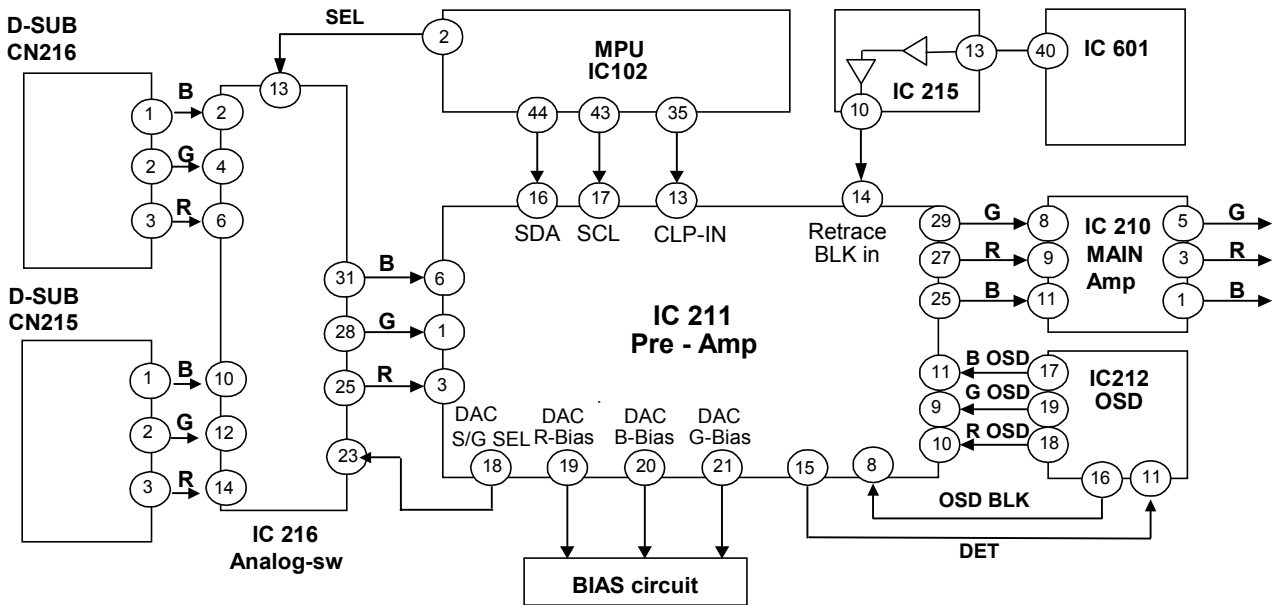

Fig. 4 Video signal amplifier circuit

#### 1.3.1.1 Video clamp

The clamp signal (positive polarity, 3.3 Vo-p) output from pin 35 of the MPU (IC102) is input to pin 13 of IC211. The clamp signal is normally set to the back of the video signal (clamp position of OSM menu: BACK). To correspond to the Sync on Green signal, the clamp signal can be set to the front of the video signal (clamp position of OSM menu: FRONT). If the signal is a separate signal, changing the clamp position of the OSM menu to FRONT or BACK will not change anything.

#### 1.3.1.2 Video blanking

The horizontal/vertical retrace line (blanking) signal (positive polarity, 3.3 Vo-p) output from pin 40 of IC601 is input to pin 13 of IC215. IC215 reverses the polarity and amplifies the waveform (positive polarity, 3.3Vo-p -> negative polarity, 5.0Vo-p -> positive polarity, 5.0Vo-p) to output the blanking signal. This blanking signal is input to pin 14 of IC211 to perform blanking operation during horizontal/vertical retracing operation.

To perform image blanking at switching the signal mode or at turning ON or OFF the power, the contrast and the brightness will be set to MINIMUM.

#### 1.3.1.3 Video mixing/amplifying

IC211 mixes the video signal with the OSM signal (G, R, and B signals of pins 9, 10, and 11) and with the video blanking signal described in Sec. 1.3.1.2. I2C bus (pins 16 and 17 of SCL and SDA) fixes the black level of the mixed video signal to 1.8V, and amplifies the mixed video signal (0.7Vp-p -> approx. 2.6Vp-p). After that, the B, R, and G signals are output from pins 25, 27, and 29, respectively. The video signal output from IC211 is input to IC210, where the signal is amplified (approx. 2.6Vp-p -> approx. 36Vp-p), and the black level is fixed to 67V. After that, the B, R, and G signals are respectively output from pins 1, 3, and 5.

#### 1.3.1.4 Control of contrast and white balance

The MPU (IC102) sends the 8-bit contrast/white balance control data to IC211 with I2C bus (SCL, SDA line). The contrast data simultaneously control 3 channels to simultaneously control the gains of the R, G, and B, and the white balance data respectively controls the gains of the R, G, and B.

### 1.3.2 Cut-off control circuit

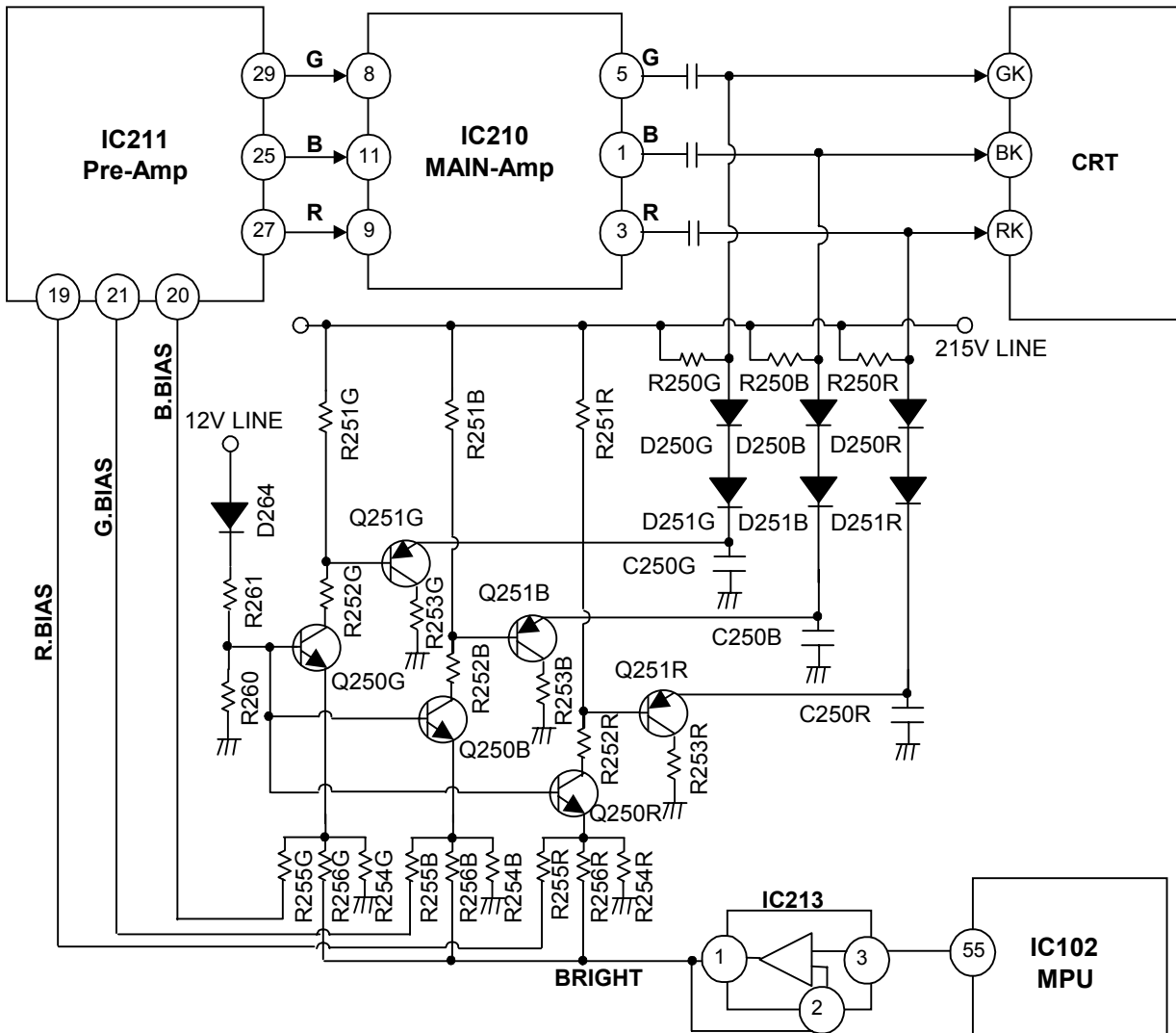

Fig. 5 Cut-off control circuit

The cut-off control circuit consists of Q250R, Q250G, Q250B, Q251R, Q251G, and Q251B, and simultaneously adjusts 3 colors (brightness), or individually adjusts 3 colors (biases of R, G, and B). The microcomputer controls both types of adjustment.

#### 1.3.2.1 Control of brightness

To simultaneously adjust 3 colors (brightness), the DAC voltage (0 to 5V, variable) line of microcomputer pin 55 is connected to the emitters of Q250R, Q250G, and Q250B via IC213. This connection enables simultaneous control of three TR collector currents and adjustment of the brightness.

#### 1.3.2.2 Control of BIAS

To individually adjust 3 colors (biases of R, G, and B), the DAC output (1.5 to 5.5V, variable) lines (pins 19, 20, and 21 of IC211) are respectively connected to the emitters of Q250R, Q250G, and Q250B via I2C bus of the microcomputer. This connection enables respective control of three TR collector currents and adjustment of biases of the R, G, and B.

### 1.3.3 OSM (On Screen Manager)

IC212 is the OSM (On-Screen Manager), and displays the screens for screen adjustment, etc. The data to be displayed on the OSM screens is sent to the MPU (IC102) via I2C bus.

### 1.3.4 2 Input change circuit

The analog switch IC216 carries out the signal selection at the time of SIGNAL-A and B simultaneous input. The signal selection is carried out by the SELECT signal of pin 3 of microcomputer IC102. By the SELECT signal of pin 3, the input signal of SIGNAL-A is selected when pin 13 (SELECT SW) of the analog switch IC206 is HIGH, and SIGNAL-B is selected when pin 13 (SELECT SW) of the analog switch IC206 is LOW.

### 1.3.5 Sync on Green circuit

The Sync on Green signal input needs to make an image signal and a composite sync signal separate. The separation method of the image signal and the composite sync signal is as follows. If a microcomputer IC102 detects a Sync on Green signal, pin 18 S/G-SEL signals of IC211 will be set to HIGH (5V), a transistor Q280 turns off, and the Sync on Green signal is output from pin 23 of IC216. The Sync on Green signal output from pin 23 is input to pin 22 of IC216, it is divided to the image signal and the composite sync signal at the inside of IC216, and only composite sync signal is output from pin 21.

### 1.3.6 Asset circuit

If the monitor power is turned OFF, 5V power will be supplied to pin 14 of EEPROM (IC217) from the PC via pin 9 of CN216, and the data stored in the EEPROM (IC217) can be read out from I2C bus.

### 1.3.7 AUTO-SIZE function

The AUTO-SIZE function detects the phase data of RGB OR signal (output to pin 11 of OSM (IC212) from pin 15 of AMP (IC211) from H-OSM and V-S signals input to pins 5 and 16 of IC212 in order to automatically adjust the screen to the optimum width and position.

Using the OSM, select AUTO SIZE ADJUST, and then press (+) button to perform automatic size adjustment.

### 1.3.8 SB MODE (Super Bright Mode) function

#### 1.3.8.1 Adjustment item/operating function in selecting SB Mode

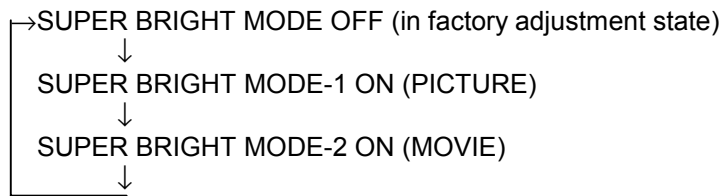

	User adjustment items related to luminance/color coordination				
	Adjustment of brightness	Adjustment of contrast	Color mode selection	Color temperature selection	Individual GAIN adjustment
SUPER BRIGHT MODE OFF	Adjustable (*1)	Adjustable (*1)	Selectable	Selectable (*2)	Adjustable (*4)
SUPER BRIGHT MODE-1 ON	Adjustable (*1)	Adjustable (*1)	Not-selectable	Selectable (*2)	Not-adjustable
SUPER BRIGHT MODE-2 ON	Adjustable (*1)	Adjustable (*1)	Not-selectable	Selectable (*2)	Not-adjustable

(\*1): Brightness and contrast are common among three display mode.

(\*2): For color temperature, the adjustment value is memorized in every display mode.

(\*4): See (\*4) mentioned in item 1.3.8.3.

	Back raster luminance	GAIN UP	compensation	Sharpness
SUPER BRIGHT MODE OFF	Normal	Normal	---	---
SUPER BRIGHT MODE-1 ON	Normal	UP	Presence	---
SUPER BRIGHT MODE-2 ON	UP	UP	Presence	Presence

### 1.3.8.2 Circuit (cathode) operation in selecting SB Mode [Window pattern]

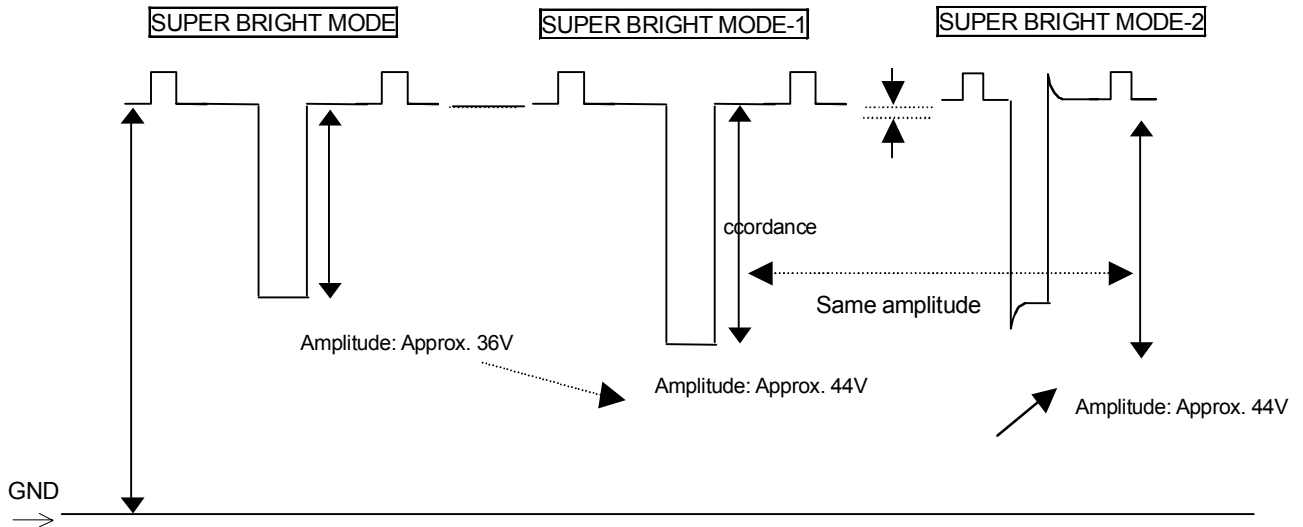

### 1.3.8.3 SB Mode setting data and control method

(OSM FACT3)	Data name	Data (hex)	
Setting of back raster luminance	SBBR1	0	BRT UP value in SUPER BRIGHT MODE-1 ON "0"=No UP
	SBBR2	32	BRT UP value in SUPER BRIGHT MODE-2 ON
Setting of GAIN UP	SBCN1	3C	Amplified value in SUPER BRIGHT MODE-1 ON (see the following formula)
	SBCN2	3C	Amplified value in SUPER BRIGHT MODE-2 ON (see the following formula)

GAIN UP formula = GAIN adjustment value (hex)(\*3) x {1+ (Data (hex) of SBCN1 or SBCN2)/FF (hex) }

(\*3): GAIN adjustment value is the following data (in OSM FACT3).

9300K	R-GN1	G-GN1	B-GN1
6500K	R-GN2	G-GN2	B-GN2
5000K	R-GN3	G-GN3	B-GN3

(\*4): When the SUPER BRIGHT MODE-1 or MODE-2 is ON, the GAIN cannot be adjusted as shown in the table in Sec. 1.3.6.1 "Adjustment item/operating function in selecting SB Mode". However, when the SUPER BRIGHT MODE is OFF, the MAX GAIN value calculated with the following formula will be written in the following EEP address so that the GAIN value cannot be increased above that of the SUPER BRIGHT MODE-1 and MODE-2 ON status.

MAX GAIN = Maximum value (hex) for R/G/B GAIN adjustment (\*5) x {1 + (SBCN1 or SBCN2 data (hex))/FF (hex)}

(\*5): R/G/B GAIN MAX value is the maximum one among GAIN adjustment value mentioned (\*3) above.

EEP address (hex)

	R	G	B
MAX GAIN	89	8a	8b

\* Every R/G/B MAX GAIN data applied to the address listed above table are totally same.

In case of repair, after CRT, Pre-AMP (IC211), MAIN-AMP (IC210), etc. are replaced and the luminance/color coordination is adjusted, the MAX GAIN value mentioned above should be rewritten.

### 1.3.9 CONSTANT BRIGHTNESS function

The brightness and color coordination of the screen will be deteriorated due to secular deterioration of the CRT. The CONSTANT BRIGHTNESS function, however, will recover the deteriorated brightness close to the initial level (level ensured at outgoing the factory).

If the CONSTANT BRIGHTNESS function is activated, operation will be performed at 106kHz horizontally and at 85Hz vertically while ignoring the input signal, and the OSM-IC (IC212) will output the reference image signal. In this condition, R744 detects the beam current flowing to pin 9 of the flyback transformer T701. This beam current is inverted and amplified by IC703, and then converted into a voltage value by the current/voltage conversion circuit. After that, the converted voltage value will be input to the A/D converter (pin 27 of IC102 (microcomputer)). To individually detect the beam current values of 3 colors (R, G, and B), the desired color only will be brightened by increasing the cut-off voltages of the other 2 colors. After obtaining the beam current values of 3 colors in this way, the obtained beam current values will be compared with the beam current values used for factory adjustment (beam current values stored in the EEPROM). After that, the cut-off voltage values of 3 colors (R, G, and B) will be adjusted so that the beam current values close to the factory adjustment values can be obtained. In this way, the cut-off conditions of the CRT will be recovered close to the factory adjustment level.

In addition, if the CONSTANT BRIGHTNESS function is activated, the C\_TIME\_SEL signal input to the base of Q704 will be set to the low level, Q704 is turned OFF, and the bias voltage will be applied to pin 5 of IC703. As a result, voltage proportional to the beam current value will be output from pin 7 of IC703. By the way, difference in the flyback transformer or the CRT may cause difference in the beam current. To eliminate such difference in the beam current, the DAC voltage (commonly used for the 6H-DC signal) can adjust the bias voltage input to pin 5 of IC703 described above. During normal operation, the C\_TIME\_SEL signal is set to the high level, Q704 is turned ON, and pin 5 of IC703 is grounded via the GND line so that the output of IC703 pin 7 can be kept at the low level. The signal output from pin 7 of IC703 is added to ABL signal with MD717 (Diode). When the CONSTANT BRIGHTNESS function is activated, the ABL signal is input to pin 27 of IC102 as the beam current signal.

## 1.4 CRT compensation block

### 1.4.1 Earth magnetism cancel circuit

This model carries IC2S0 (geomagnetism sensor unit) that carries out the voltage conversion of the magnetic field intensity of a north-south magnetic field and an east-west magnetic field. IC2S0 detects the detected voltage and controls the various canceling functions described below automatically.

- South-north horizontal magnetic field rotation canceling function
- East-west horizontal magnetic field raster vertical position canceling function
- South-north horizontal magnetic field landing canceling function
- East-west horizontal magnetic field landing canceling function
- South-north horizontal magnetic field convergence canceling function
- East-west horizontal magnetic field convergence canceling function

Here, the output voltage of IC2S0 (earth magnetism sensor unit) operates as follows.

- South-north horizontal magnetic field (IC2S0 pin 5): 1.0V (-0.04mT) to 2.5V (+/-0.00mT) to 4.0V(+0.04mT).
- Vertical magnetic field (IC2S0 pin 4): 4.0V (-0.04mT) to 2.5V (+/-0.00mT) to 1.0V (+0.04mT).

<Vertical magnetic field canceling function>

(a) Landing compensation

V-6H (Schematic Diagram) and PWB-V-6H (PWB) are added so that the CRT specified for Northern Hemisphere ITC can be adjusted to the spec for Southern Hemisphere ITC.



Some circuits are also added to DEFL-SUB (Schematic Diagram) and PWB-DEFLSUB (PWB).

In PWB-V-6H a vertical sync. parabola waveform output from pin 59 of IC601 (1 bit DAC) is supplied from pin 1 of CN804 and 300mA<sub>p-p</sub> parabola waveform (vertical sync.) current flows to the speed modulating coil from pin 1 of CN8P2 via Q8P0 and Q8P1.

In PWB-DEFLSUB a vertical sync. parabola waveform output from pin 59 of IC601 (1 bit DAC) is reversed and amplified via Q600 and it is associated to the horizontal phase deflection compensation waveform output from pin 57 of IC601 to compensate side pin balance.

(b) Vertical magnetic field landing cancel

The vertical magnetic field landing cancel circuit is the one to compensate the color shade and deviation that reaches its maximum at the center in the horizontal axis direction and its minimum at the upper and lower ends on the monitor surface.

The automatic adjustment is done by controlling DC level of the above 300mA<sub>p-p</sub> parabola waveform flowing to the speed modulating coil installed in the neck part of CRT.

It is controlled by pin 46 of IC 102 (DAC "V CANCEL"), and controls the speed modulating coil with DC level of +/-50mA by Q8P0 and Q8P1.

(c) Vertical magnetic field convergence cancel

The vertical magnetic field convergence cancel circuit is the circuit to compensate for the misconvergence that results after the vertical convergence of RED and BLUE reversed at the upper and lower ends on the whole display area of the monitor deteriorates, and it is automatically adjusted by the saw-toothed waveform (vertical-frequency) current flowing to the 4V convergence compensation coil mounted on DY. It is controlled with the AC component (YVJT & YVJB, vertical frequency saw-toothed waveform) by pin 60 of IC601 (4V\_SC), and saw-toothed waveform (vertical frequency) current of +/-45mA (peak) is made to flow to the 4V convergence compensation coil by pin 6 of IC8A1 (PowerOpamp).

#### 1.4.2 Rotation circuit

The rotation circuit is a circuit to compensate the picture inclination caused by the earth magnetism by letting DC current flow to the rotation coil wound on the front side of DY for adjustment. It is controlled to 0 to 5V with the reference of 2.5V by IC102 pin 45 (PWM\_DAC), and DC current of +/-100mA (max) is made to flow to the rotation coil by IC804 pin 2.

This compensation circuit has two functions; (1) User adjustment (OSM display) and (2) Southern/Northern horizontal magnetic field rotation cancellation.

#### 1.4.3 East-west horizontal magnetic field vertical position canceling function

It is the function that detects the detection voltage change from IC2S0 (geomagnetism sensor unit) by east-west horizontal magnetic field change, and cancels a changed part of a raster vertical position automatically.

#### 1.4.4 Corner purity circuit

The corner purity circuit is a circuit to compensate for the color shade and color deviation of the picture corner. On the rear side of CRT, it is adjusted by DC current flowing to the corner purity coils installed in the four corners on the display surface.

The compensation circuit is composed of the following five functions of (1) User adjustment (OSM display), (2) Aging variation compensation, (3) High/low temperature drift compensation, (4) South-north horizontal magnetic field landing cancel and (5) East-west horizontal magnetic field landing cancel.

(1) User adjustment (OSM display)

The user causes DC current of +/-60mA (max) to flow to the purity coil of each corner according to the value displayed on OSM.

(2) Aging variation compensation

As the electronic beam collides with the aperture grille, it is thermally expanded and contracted. The thermal expansion/contraction is varied according to the elapse of the power ON/OFF time of the monitor. The color shade and deviation of the picture corner thus generated are automatically adjusted.

The voltage of the beam current supply pin (T701 pin 9) is detected with R723/R724, and the voltage that detects the time elapse of the power ON/OFF of the monitor is read from the CR charge (integration) circuit composed of C723 and R738, and CR discharge (integration) circuit composed of C723 and R737 through IC702 (buffer amplifier) by IC102 pin 26 (CPU\_ADC), then, the DC current of +/-19mA (max) flows to the purity coil on each corner according to the specified control program.

- (3) High/low temperature drift compensation  
The front panel (glass) is thermally expanded and contracted as the temperature varies in the installation environments of the monitor. The color shade and deviation of the picture corner are automatically adjusted. The voltage that detects the temperature variation of the installation environments of the monitor is read from the environment temperature detection circuit composed of TH100 (thermistor) arranged near the front panel (glass) by IC102 pin 25 (CPU\_ADC), and DC current of +/-13mA (max) is made to flow to the purity coil on each corner according to the specified control program.
- (4) South-north horizontal magnetic field landing canceling function  
North-south magnetic field landing canceling adjusts automatically the color irregularity and color shading/impurity which are generated horizontal direction served as an opposite direction at the upper end and lower end of a monitor display side. Detection voltage and a direction of the north-south magnetic field (IC2S0 pin 5) are detected by IC2S0 (geomagnetism sensor unit) and pin 29 (CPU\_ADC) of IC102 reads the detection voltage, and DC current of  $\pm 21$ mA (Max) is passed in each corner purity coil according to the predetermined control program.
- (5) East-west horizontal magnetic field landing canceling function  
East-west horizontal magnetic field landing canceling adjusts automatically the color irregularity and color shading/impurity which are generated horizontal direction served as an opposite direction at the upper end and lower end of a monitor display side. Detection voltage and a direction of the north-south magnetic field (IC2S0 pin 4) are detected by IC2S0 (geomagnetism sensor unit) and pin 28 (CPU\_ADC) of IC102 reads the detection voltage, and DC current of  $\pm 21$ mA (Max) is passed in each corner purity coil according to the predetermined control program.

#### 1.4.4.1 Corner purity circuit operation

<TL: Upper left corner>

Pin 50 (PWM\_DAC) of IC102 controls the TL in the range of 0 to 5V while regarding 2.5V as the reference voltage, and the DC current of the above value will flow from pin 2 of IC803 to the upper left corner purity coil.

<TR: Upper right corner>

Pin 49 (PWM\_DAC) of IC102 controls the TR in the range of 0 to 5V while regarding 2.5V as the reference voltage, and the DC current of the above value will flow from pin 8 of IC803 to the upper right corner purity coil.

<BL: Lower left corner>

Pin 52 (PWM\_DAC) of IC102 controls the BL in the range of 0 to 5V while regarding 2.5V as the reference voltage, and the DC current of the above value will flow from pin 2 of IC801 to the lower left corner purity coil.

<BR: Lower right corner>

Pin 51 (PWM\_DAC) of IC102 controls the BR in the range of 0 to 5V while regarding 2.5V as the reference voltage, and the DC current of the above value will flow from pin 8 of IC801 to the lower right corner purity coil.

#### 1.4.5 Vertical magnetic field landing cancel circuit

The vertical magnetic field landing cancel circuit is the circuit to compensate for the color shade and deviation that reaches its maximum at the center in the horizontal axis direction and its minimum at the upper and lower ends on the monitor surface, and the adjustment is done by DC current according to the value displayed on OSM flowing to the speed modulating coil installed in the neck part of CRT.

It is controlled with 0 to 5V of 2.5V reference by IC102 pin 46 (PWM-DAC), and DC current of +/-150mA (max) is made to flow to the speed modulating coil by IC804 pin 8.

#### 1.4.6 Digital dynamic convergence clear (DDCC) circuit

In the digital dynamic convergence clear (hereafter called DDCC) circuit, the convergence compensating current waveform is produced and amplified, and the convergence is compensated by the compensation current flowing to the sub yoke that is installed as the rear unit of the deflection yoke.

Though the principle of the convergence compensation with the sub yoke is same as the CP ring, the CP

ring is used for the static variation with the parallel movement in the whole picture in the uniform magnetic field with the permanent magnet but the sub yoke is used for dynamic variation that compensates a desired position on the picture by controlling the current waveform that flows to the coil of the electric magnet. (See Fig. 7)

### 1.4.6.1 Production of compensation current waveform

There are 30 kinds of compensation elements, and they are programmed in IC601 one by one using the function. Inputting the compensation coefficient into the function controls the amplitude of the current.

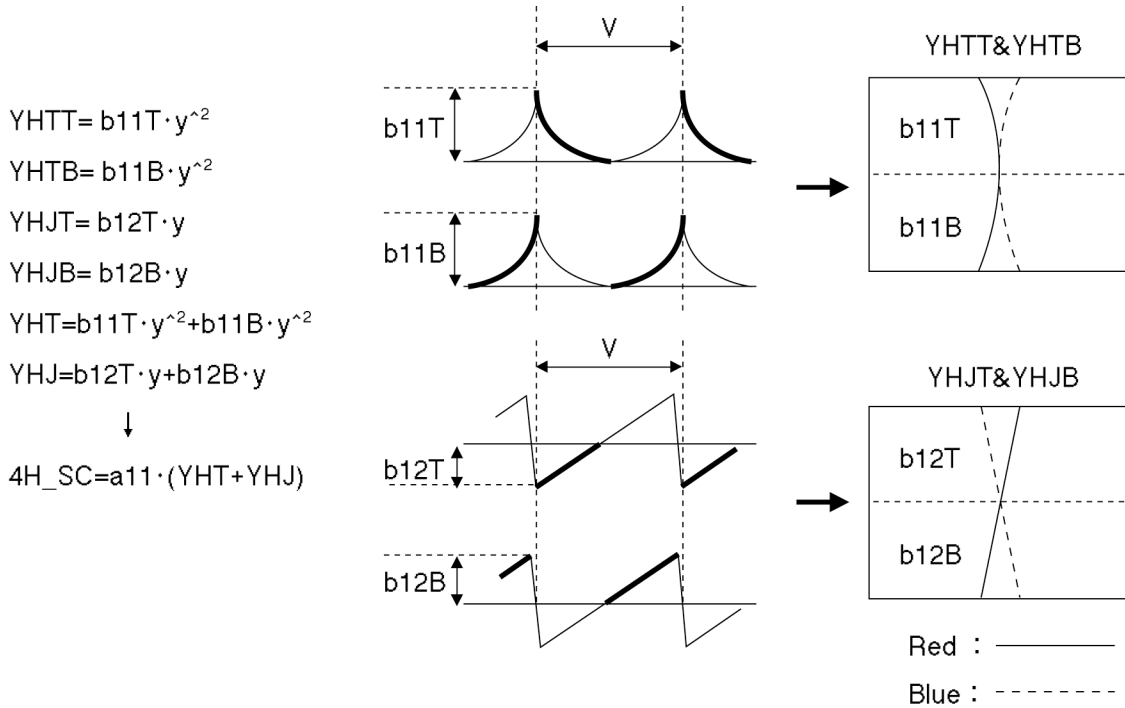

Fig. 6 DDCC compensation image

Examples of the functions and current waveform/compensation operation of YH (YHTT, THTB, YHJT, YHJB) are shown as follows.

In the above formulas, b11T, b11B, b12T and b12B express the compensation coefficients, and y and y<sup>2</sup> express the primary and secondary functions of the vertical frequencies.

The other parts except the compensation coefficients are programmed, and desired amplitudes (= compensation amount) are gained by varying the coefficients.

YHTT and YHTB compensate the upper and lower parts of the picture of the characteristic components of their DYs to compensate the upper and lower parts of the picture of the axis deviation component. The component gained by adding YHT and YHJ is multiplied by the offset compensation coefficient a11. The resultant component is regarded as 4H\_SC, and is output from IC601 pin 61.

### 1.4.6.2 Waveform, and operation on the picture

The case in which the currents flow through 4H coils of the sub yoke is explained. Regarding YHT (secondary function in the vertical frequency), in case of Fig. 6 as an example, the current is large in the same direction at the start (upper end of the picture) and the end (lower end of the picture) of the vertical frequency, and is zeroed on the X axis of the picture. Therefore, the magnetic field that is proportional to it is generated, and RED and BLUE vary in the same direction only at the upper and lower ends of the picture. As aforementioned, YHT can be independently controlled at the upper part (b11t · y<sup>2</sup>) and lower part (b11B · y<sup>2</sup>).

Moreover, regarding YHJ (primary function in the vertical frequency), if the flowing direction of the current is opposite at the start (upper end of the picture) and the end (lower end of the picture) of the vertical frequency as an example, RED and BLUE vary in the opposite direction only at the upper and lower ends of the picture. Making the current flow to the 4V coil can do compensation in the vertical direction.

Fig. 8 (a) and (b) shows the image of each adjustment item of the DDCC adjustment.

### 1.4.6.3 Adjustment method

Before the adjustment with the compensation circuit, it is necessary that they are properly adjusted at the center (H-STATIC and V-STATIC), on the X axis (XH slider, B-Bow 4P, XV differential coil) and on the Y axis (YH volume, YV volume).

Though DC current is superimposed on the sub yoke, H-STATIC and V-STATIC are pushed to the greatest possible extent by the adjustment with CP ring in order to reduce the stress of the driver IC8A1 (STK391-110).

Moreover, although 6H coil is carried in the case of this chassis, in addition to 4H and 4V coils, since the range which can be adjusted is a range used as fine adjustment, it is a premise that the convergence between Red, Blue and Green (6H and 6V) is in a standard as a performance of ITC (CRT&DY) in the state where 6H coil is not used.

As the adjustment procedure, the adjustment values of 30 elements are not respectively zeroed but they are adjusted to nearest to zero with a total balance in good order.

In other words, the balance (compromise) adjustment with each adjustment item is applied.

The correspondence of the names of DDCC adjustment mode to the coefficients of all 30 elements is shown below.

#### <Factory mode>

4H Coil	b11T	YHTT	$y^2$	b11B	YHTB	$y^2$	b12T	YHJT	y	b12B	YHJB	y
	b21L	XHL	$x^2$	b21R	XHR	$x^2$						
	b31TL	S3HTL	$x^2 \cdot -(y^3+y^4+y^5+y^6)$	b31TR	S3HTR	$x^2 \cdot -(y^3+y^4+y^5+y^6)$	b31BL	S3HBL	$x^2 \cdot -(y^3+y^4-y^5+y^6)$	b31BR	S3HBR	$x^2 \cdot -(y^3+y^4-y^5+y^6)$
	b41TL	PQHTL	$x^2 \cdot y^4$	b41TR	PQHTR	$x^2 \cdot y^4$	b41BL	PQHBL	$x^2 \cdot y^4$	b41BR	PQHBR	$x^2 \cdot y^4$
4V Coil	c11T	YVTT	$y^2$	c11B	YVTB	$y^2$	c12T	YVJT	y	c12B	YVJB	y
	c21L	XVL	$x^2$	c21R	XVR	$x^2$						
	c31TL	S3VTL	$x^2 \cdot -(y^3+y^4+y^5+y^6)$	c31TR	S3VTR	$x^2 \cdot -(y^3+y^4+y^5+y^6)$	c31BL	S3VBL	$x^2 \cdot -(y^3+y^4-y^5+y^6)$	c31BR	S3VBR	$x^2 \cdot -(y^3+y^4-y^5+y^6)$
	c41TL	PQVTL	$x^2 \cdot y^4$	c41TR	PQVTR	$x^2 \cdot y^4$	c41BL	PQVBL	$x^2 \cdot y^4$	c41BR	PQVBR	$x^2 \cdot y^4$

#### <User & Factory mode>

4H Coil	a11	H-CONVERGENCE	DC
4V Coil	a12	V-CONVERGENCE	DC

### 1.4.6.4 Block diagram

Fig. 9 shows the block diagram of the DDCC circuit.

The components 4H\_DC (pin 6), 4H\_SC (pin 61), 4V\_DC (pin 8) and 4V\_SC (pin 60) supplied from IC601 to 4H-Coil and 4V-Coil are output, the dynamic component (4H\_DC, 4V\_DC) is amplified with IC6A2, and the static component (4H\_SC, 4V\_SC) is amplified with IC6A3.

DDC (pin 7) output from IC601 and DEFL\_+3.3V (pin 3) output from IC602 are respectively the reference voltage of Op-Amp (IC6A2) that amplifies the above dynamic component (4H\_DC, 4V\_DC) and the reference voltage of Op-Amp (IC6A3) that amplifies the static component (4H\_SC, 4V\_SC).

On each of 4H and 4V, the waveform added with the dynamic component and static component is input to IC8A1 pin 3 and pin 4, and it allows the specified current to flow to each convergence compensation coil.

For four poles magnetic field

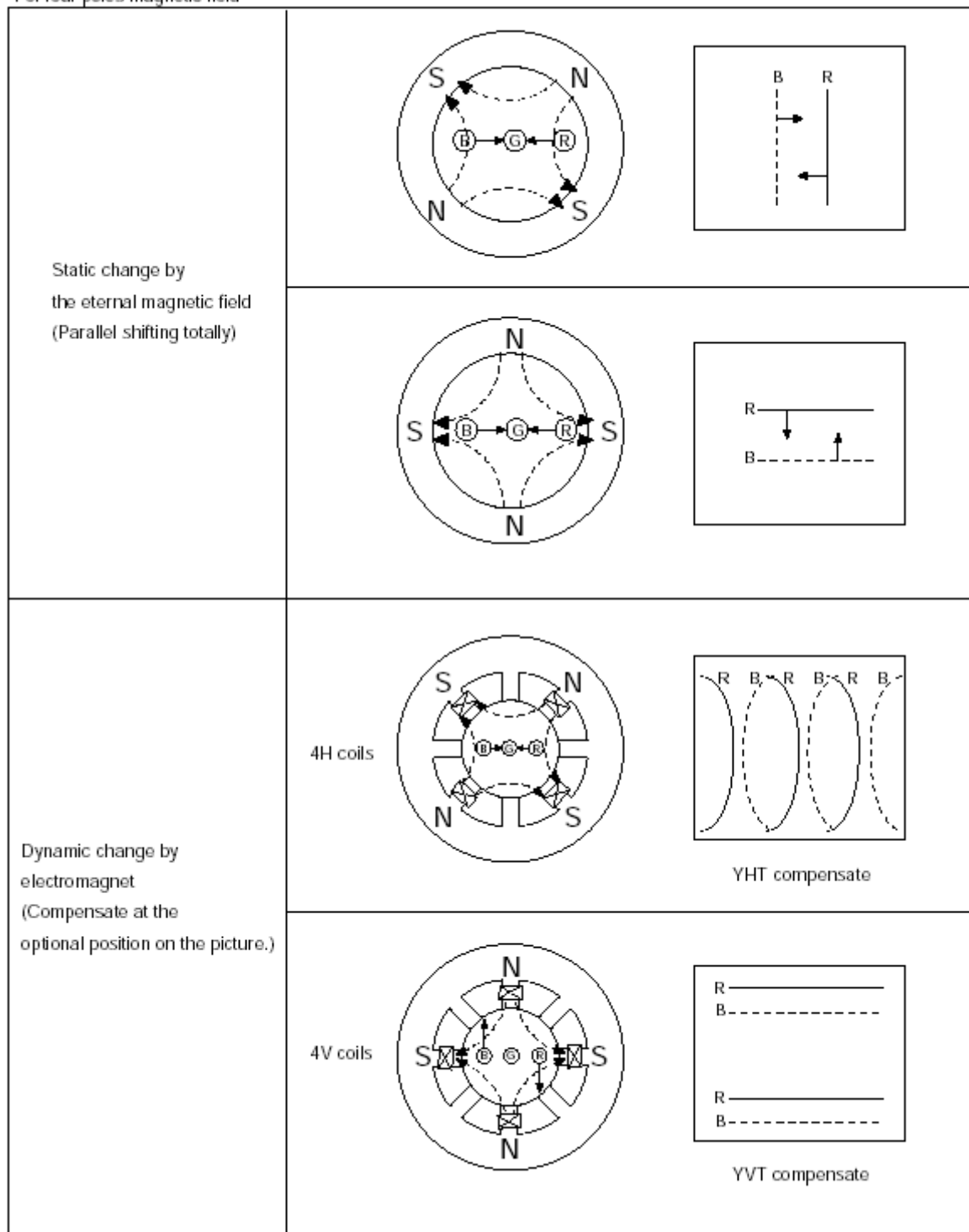
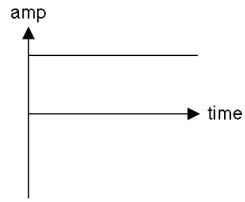
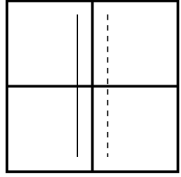

Fig. 7 The principle of DDCC compensation

RED —————  
 BLUE - - - - -

H-CONVERGENCE



YHTT&YHTB

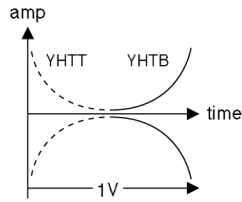
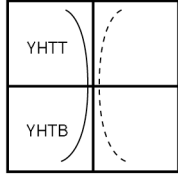

YHJT&YHJB

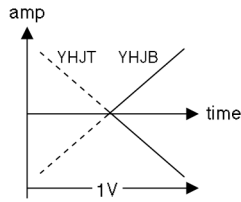
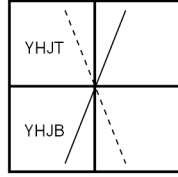

PQHTL

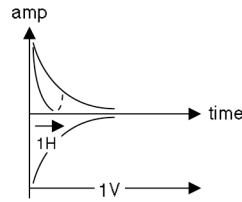
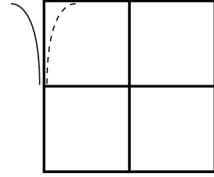

PQHTR

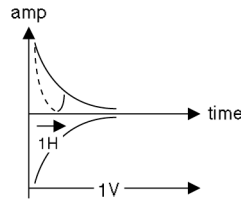
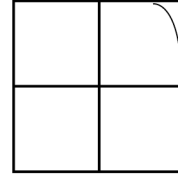

PQHBL

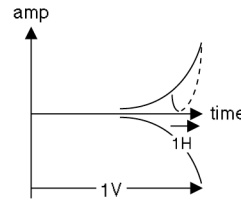
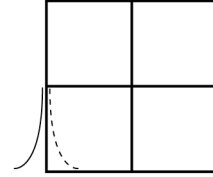

PQHBR

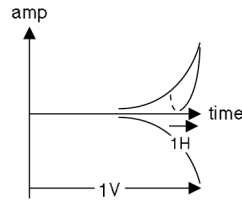
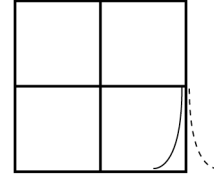

V-CONVERGENCE

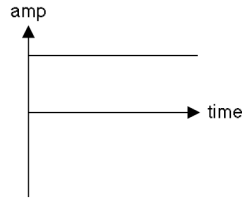
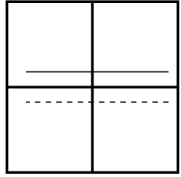

YVTT&YVTB

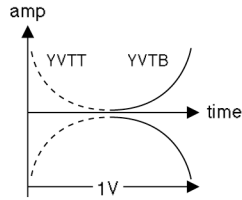
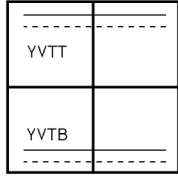

YVJT&YVJB

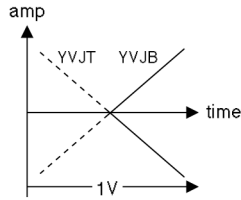
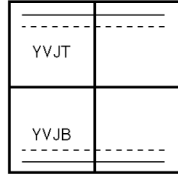

PQVTL

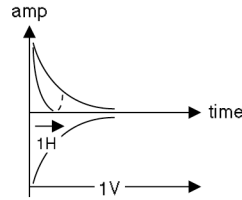
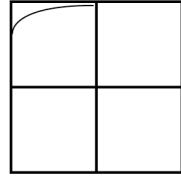

PQVTR

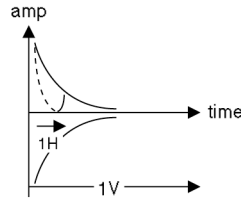
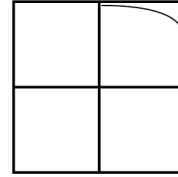

PQVBL

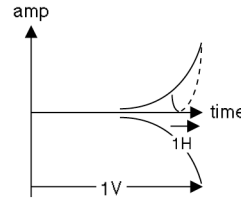
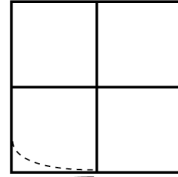

PQVBR

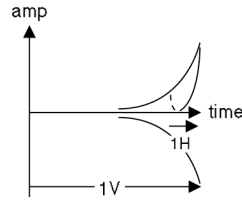
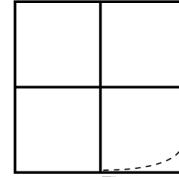

Fig. 8 (a) DDCC adjustment item

RED ————  
 BLUE - - - - -

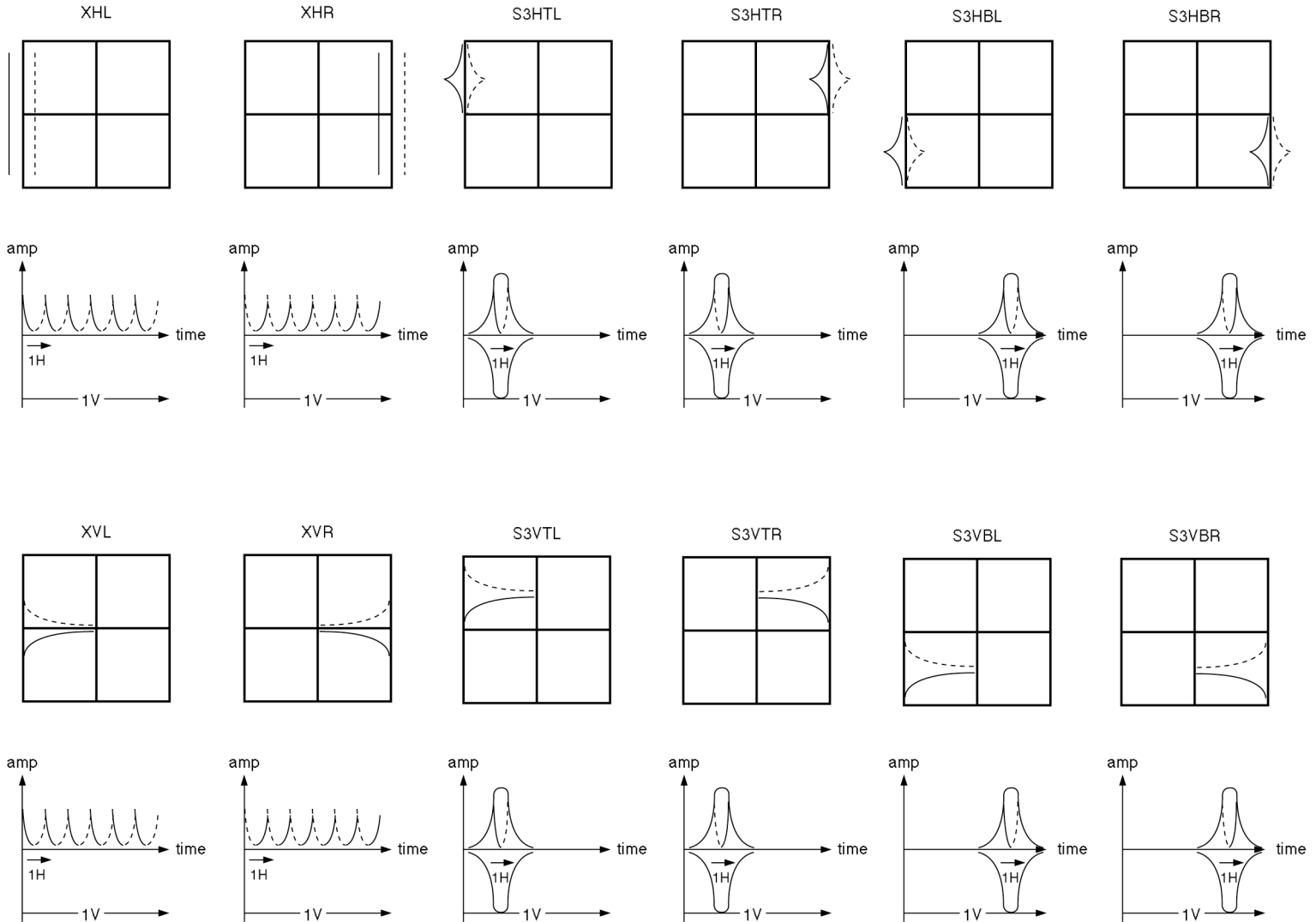
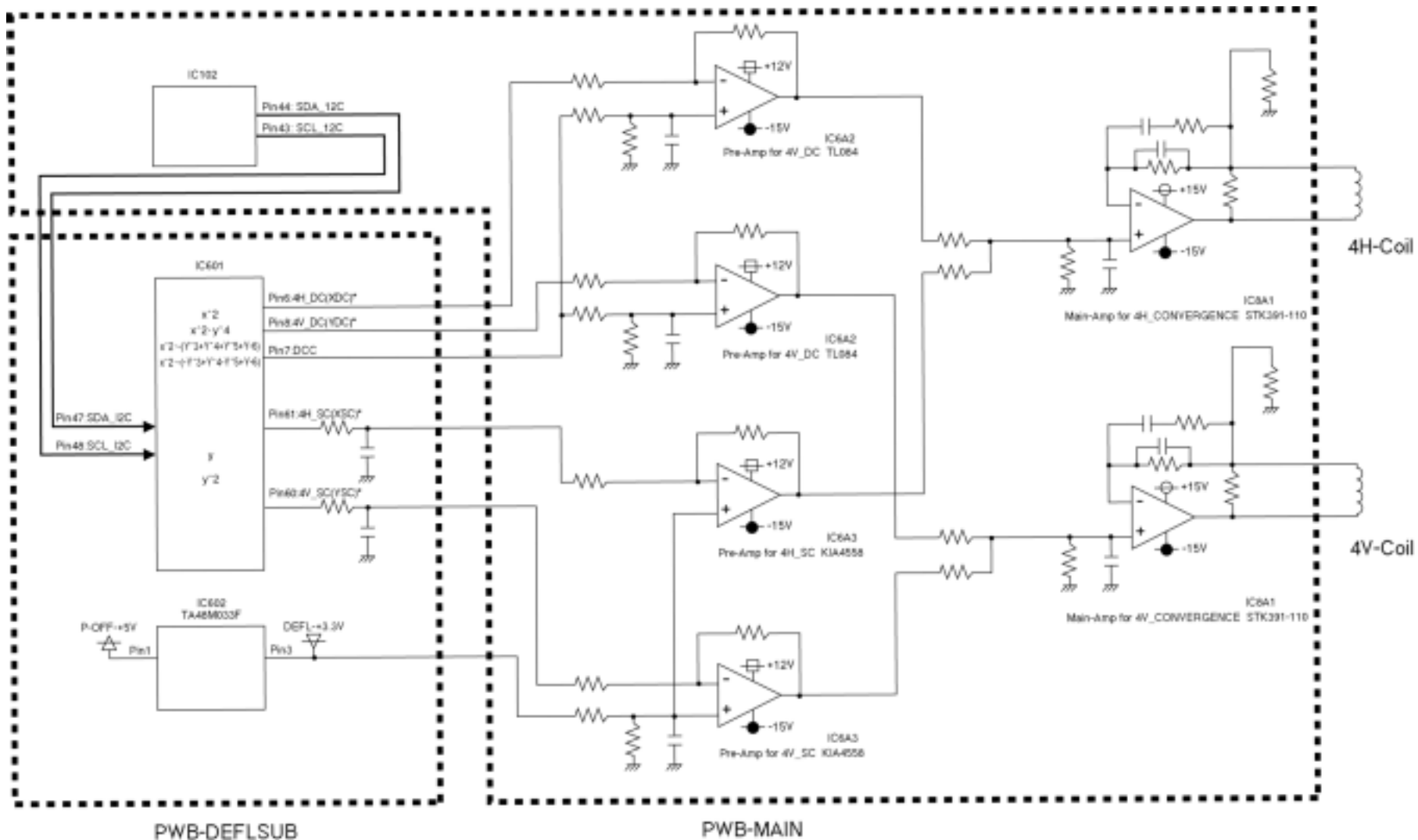

Fig. 8 (b) DDCC adjustment item



PWB-DEFLSUB

PWB-MAIN

✖ PIn5.4H\_DC(XDC) = XHL+XHR+S3HTL+S3HTR+S3HBL+S3HBR+PQHTL+PQHTR+PQHBL+PQHBR  
 PIn8.4V\_DC(YDC) = XVL+XVR+S3VTL+S3VTR+S3VBL+S3VBR+PQVTL+PQVTR+PQVBL+PQVBR  
 PIn61.4H\_SC(XSC) = H-CONVERGENCE - (YHTT+YHTB+YHJT+YHJB)  
 PIn60.4V\_SC(YSC) = V-CONVERGENCE - (YVTT+YVTB+YVJT+YVJB)



### 1.4.7 East-west horizontal convergence canceling function

It is the function which rectifies automatically change of YHJT, YHJB and XVL, and XVR (between Red and Blue) by east-west magnetic field change, detects the detection voltage change from IC2S0 (geomagnetism sensor unit), and is carrying out automatic compensation.

## 1.5 USB circuit

### 1.5.1 Outline

This monitor loads the standard USB SELF POWERED HUB with 1 upstream and 4 downstreams.

#### (1) Serial data bus

Data bus is connected from upstream connector CN1A0 to upstream port of HUB controller IC1A0, and downstream connectors CN1A1 to CN1A4 are connected from HUB controller.

HUB controller relays data communication between the upstream side (PC) and the downstream side (device).

Downstream connection of HUB controller

Port on circuit diagram	Connector	Silk indication
Port 1	CN1A1	1
Port 2	CN1A2	4
Port 3	CN1A3	3
Port 4	CN1A4	2

#### (2) Power supply to downstream

USB HUB of this monitor is SELF POWERED HUB, and it can supply the power of +5V 500mA (max) to each downstream from transformer T902 on PWB-MAIN. Further, HUB controller IC1A0 has the function of detecting overcurrent, and stops supplying the power to each downstream port when overcurrent (500mA or more) is detected at each port.

### 1.5.2 USB downstream power supply

#### (1) Supply of Vpp power

When HUB controller IC1A0 is recognized from the direction of upstream, the signal which functions as a switch of power output for a downstream port is output (IC1A0 pins 2, 16, 17 and 32).

When IC1A0 pins 2, 16, 17 and 32 become LOW, FET gates are turned ON (LOW), and EFT transistors Q1A1, Q1A2, Q1A3 and Q1A4 supply the power to the downstream ports (CN1A1 to CN1A4) respectively.

#### (2) Detection of overcurrent

HUB controller IC1A0 has the function of detecting overcurrent. If the current output at each port exceeds 550mA (min), gates of FET transistors Q1A1, Q1A2, Q1A3 and Q1A4 turn OFF (HIGH), automatically output of current stops only to the port that overcurrent is detected.

In order to re-operate the port that overcurrent is detected, either of the followings should be carried out:

- 1.OFF/ON of monitor power supply
- 2.Pulling-out and pulling-in of upstream cable
- 3.Restart of PC

### 1.5.3 HUB controller power output

HUB controller IC1A0 has a built-in 3.3V regulator, and outputs from IC1A0 pin 1.

### 1.5.4 USB power on reset

At the time of a power ON and spark detection circuit operation, the reset pulse to USB is output to pin 21 of IC1A0 from pin 2 of IC102. At pin 21 of IC1A0, it is reset by LOW and is reset release by HIGH.

## **1.6 Control block**

### **1.6.1 Function of control circuit**

The control block is mainly on MAIN board and DEFL-SUB board, and the function is as follows.

- (1) Auto-tracking
- (2) Control of picture size, distortion and position
- (3) Adjustment data memory
- (4) Sync. signal detection
- (5) OSM control
- (6) Video pre-amp control and clamp pulse position control
- (7) Power ON/OFF control
- (8) Heater voltage control
- (9) DDC 1 / 2B / 2Bi
- (10) Operating time display

The control block is composed of the following four components.

- |                         |                     |
|-------------------------|---------------------|
| (1) Microcomputer:      | IC102 (MAIN board)  |
| (2) OSM IC:             | IC212 (VIDEO board) |
| (3) EEPROM:             | IC104 (MAIN board)  |
| (4) Sync. signal input: | IC215 (VIDEO board) |

### **1.6.2 Auto-tracking process**

The microcomputer (IC102) calculates the frequency of the sync. signal input and outputs the distortion compensation data corresponding to the input signal timing to the deflection IC (IC600).

Control with IC600 is carried out via I2C bus.

### **1.6.3 EEPROM**

The capacity of the EEPROM (IC104) is 32 kilobits (4 kilobytes). The factory adjustment data, user adjustment data, and EDID data are stored in the EEPROM.

Up to 10 items can be stored as the factory preset data, and up to 16 items can be stored as the user preset data. Regarding the factory preset timing, if the user reset the memory, the factory adjustment data will be called up.

The EDID data is stored in the last 128-byte area.

### **1.6.4 On-Screen-Manager (OSM) controller**

The On-Screen-Manager (OSM) controller IC IC212 displays the picture used for picture adjustment and so on. OSM display data is sent from the microcomputer (IC102) via I2C bus.

### **1.6.5 Heater voltage control**

In the normally ON status, the heater voltage is supplied from the +8V line of the main power circuit. Heater resistor R203H connected in series adjusts this supplied voltage to +6.15V (typ) (rated voltage for the CRT) before application. In the suspend mode, the sub-power circuit applies the voltage so that the screen can be instantaneously recovered. (In the suspend mode, the heater voltage is low compared with that of the normally ON status.)

### **1.6.6 Protection circuit operation**

This monitor can detect the following problems, and can stop the monitor operation after detection of a problem. If the protector function is activated, the Power-On Indicator (LED) will flicker so that you can localize the activated protector.

#### **1.6.6.1 X-ray protector**

The CRT monitor radiates X-rays, and exposure to too much radiation is very dangerous. For this reason, the CRT monitor incorporates an X-ray protector. If the high voltage value rises above the specified value, the protector will automatically stop applying the high voltage. For this model, the X-ray protector activation point is set to 31.0kV (entirely black screen).

To disable the X-ray protector for the reason of repair, etc., set the monitor in the factory mode.

### 1.6.6.2 High voltage data error detection

Important safety data, such as the high voltage adjustment value and the X-ray protector activation voltage, are stored in the EEPROM. For each safety data, there is backup data. If both data values differ from each other, the monitor will enter the power saving mode (the high voltage will not be applied).

### 1.6.6.3 Beam current protector

If too much beam current flows (1.5mA or more), "H" will be input to the ABL terminal (pin 27 of the microcomputer (IC102)). From this terminal, the microcomputer will detect overflow of the beam current, and will set the monitor in the power saving mode.

### 1.6.6.4 Power-On Indicator (LED) flickering pattern in each protector operating

If a protector is activated, the Power-On Indicator (LED) will flicker as shown below to indicate the activated protector (to show the cause of the problem).

Table 2 Power-On Indicator (LED) flickering pattern in each protector operating

Protector state	Power-On Indicator (LED) state	
	Short (0.5s) lighting times	Long (2s) lighting times
X-ray protector	1	1
High voltage circuit latch detection	2	1
Data protector	3	1
Beam protector	5	1
+B short-circuit	7	1

### 1.6.6.5 Operating time

If "DIAGNOSIS" is selected from the menu in the factory mode, the monitor operation time will appear. 0.5 hours will be added to this value every 30 minutes.

P: Indicates the power-on time (including the operation time in the power saving mode).

K: Indicates the heater power-on time.

### 1.6.6.6 The DDC communication

The microcomputer carries out the DDC communication. For this communication, the microcomputer reads out the EDID data from the EEPROM, and stores the data in the RAM. When receiving a request from the PC, the microcomputer will output the data from pins 8 and 11.

### 1.6.6.7 Microcomputer pin assignment

#	PORT	ASSIGN	I/O	FUNCTION	#	PORT	ASSIGN	I/O	FUNCTION
1	H_LOCK	IRQ2/P40	I	H_UNLOCK detection	64	CS8	P37	O	CS switching 8
2	USB-SPARK USB-RESET	IRQ1/P41	I/O	For FLASH writing	63	CS7	P36	O	CS switching 7
3	INPUT SEL	IRQ0/P42	O	Power cut detection	62	CS6	P35	O	CS switching 6
4	HSK	RD/P43	O	SOA output	61	CS5	P34	O	CS switching 5
5	SUSPEND	WR/P44	O	Suspend	60	CS4	P33	O	CS switching 4
6	C TIME SEL	IOS/AS/P45	O		59	CS3	P32	O	CS switching 3
7	OPTION	EXCL/o/P46	I	(available as input port)	58	CS2	P31	O	CS switching 2
8	DDC_DATA	SDA0/WAIT	I/O	DDC data	57	CS1	P30	O	CS switching 1
9	FLASH_TX	TxD0/P50	O	PZTAT	56	HVADJ	P10/PWMX0	P	HVADJ
10	BEAM/SHORT	RxD0/P50	I	Beam protector	55	BRIGHTNESS	P11/PWMX1	P	Brightness
11	DDC_SCL	SCL0/SCK0	I/O	DDC clock	54	SW LIN2	P12/PW2	O	SW LIN2
12	RESET	RES	I	Reset	53	SW LIN1	P13/PW3	O	SW LIN1
13	NMI	MNI	I	NMI	52	PURITY_BL	P14/PW4	P	Corner purity BL
14	(+) 5V	Vcc			51	PURITY_BR	P15/PW5	P	Corner purity BR
15	STBY	STBY	I		50	PURITY_TL	P16/PW6	P	Corner purity TL
16	GND	GND			49	PURITY_TR	P17/PW7	P	Corner purity TR
17	X'TAL	XTAL			48	GND	Vss		
18	X'TAL	EXTAL			47	DEGAUSS	P20/PW8	O	DEGAUSS
19	MODE SW1	SW1		Mode setting	46	V_CANCEL	P21/PW9	P	V. magnetic field cancel output
20	MODE SW2	SW2		Mode setting	45	ROTATION	P22/PW10	P	Rotation
21	GND	AVss			44	IIC_SDA	SDA1	I/O	Internal IIC data
22	KEY1	AN0/P70	A/D	Key input	43	IIC_SCL	SCL1	I/O	Internal IIC clock
23	KEY2	AN1/P71	A/D	Key input	42	P OFF	P25/PW13	O	POWER OFF
24	X RAY PRO	AN2/P72	A/D	X-ray protector	41	LIN PWM1	P26/PW14	P	H. linearity
25	TEMP	AN3/P73	A/D	Temp. detection	40	6H	P27/PW15	P	6H
26	BEAM TIME	AN4/P74	A/D	Time detection	39	Vcc	Vcc		
27	ABL/C TIME	AN4/P75	A/D	Heater voltage detection	38	Hsync OUT	P67/HSYNCO	O	H. sync. output
28	EW_SENSE	AN6/P76	A/D	H. magnetic field detection	37	SOG IN	P66/CSYNCI	I	SYNC ON G input
29	SN_SENSE	AN7/P77	A/D	V. magnetic field detection	36	HSYNC IN	P65/HSYNCI	I	H. sync. input
30	Vcc	AVcc			35	CLAMP OUT	P64/CLAMPO	O	CLAMP OUT
31	LED	HFBACK/P60	O	LED output	34	HSYNC SEL	P63/VFBACKI	O	HSYNC SEL
32	VSYNCO OUT	VSYNCO/P61	O	V. sync. output	33	VSYNCO IN	V_SYNCI	I	V. sync. input

## **1.7 X-ray protection circuit and safety protection circuit**

### **1.7.1 X-ray protection circuit**

This circuit prevents X-ray radiation from exceeding the dangerous level due to the abnormal rise of high voltage.

Do not modify the high voltage circuit and the safety protection circuit.

The upper limit of the high voltage value and the beam current value are determined by the X-ray radiation upper limit curve of CRT.

In the X-ray protection circuit, the X-ray protector activation voltage depends on the beam current. The X-ray protector, however, is normally activated at approximately 30kV (when the beam current is approximately 1mA). D709 and C704 rectify the increase in the pulse voltage output from pin 6 of T701. Pin 24 of IC102 detects this rectified voltage. If the detected voltage exceeds the specified value, the SUSPEND signal output from pin 5 of IC102 will be set to 'Low', and the P-OFF signal output from pin 42 will be also set to 'Low' (power-off mode). In addition, operation of IC701 will be stopped. This condition of the protection circuit will be retained until the power switch is turned OFF.

### **1.7.2 Beam current protection circuit**

When the current supplied to the high voltage generating winding of FBT exceeds approx. 1.5mA, the protection circuit functions. The detection of the beam current is executed by the voltage fall of R722 connected between T901 pin 9 and the 12V.

Resistors R723 and R724 divide the potential of this voltage. The divided voltage is then input to pin 27 of IC102 via IC703. If the input voltage exceeds the specified value, the SUSPEND signal output from pin 5 of IC102 will be set to 'Low', and the P-OFF signal output from pin 42 will be also set to 'Low' (power-off mode). In addition, operation of IC701 will be stopped. This condition of the protection circuit will be retained until the power switch is turned OFF.

### **1.7.3 IC701 overcurrent protection circuit**

The peak value of the drain current of Q701 and the both-end voltages of source resistors R708 and R709 are detected by pin 2 of IC701. If the voltage of this pin exceeds 1.2V (typ), pin 9 of IC701 will stop outputting the drive waveform. If the voltage of IC701 pin 2 drops below 1.2V (typ), pin 9 of IC701 will output the drive waveform again.

### **1.7.4 IC701 overload protection circuit**

If overload occurs consecutively and the overcurrent protection circuit is activated consecutively, this overload protection circuit will enter the latch mode to stop operation. If the voltage of IC701 pin 2 exceeds 1.0V (typ), C709 will be charged. If the voltage of IC701 pin 13 exceeds 2.5V (typ), IC701 will enter the latch mode to stop the control operation. This condition of the protection circuit will be retained until the power switch is turned OFF.

### **1.7.5 IC902 overcurrent protection circuit**

IC902 is equipped with an overcurrent protection circuit. R928 detects the drain current of the incorporated FET. If the voltage of IC902 pin 1 exceeds approximately 0.7V, this overcurrent protection circuit will be activated.

### **1.7.6 Short-circuit protection circuit on secondary power side**

The output line of each secondary power (+215V, +80V, +15V, +8V, -15V) is equipped with a short-circuit detection circuit. If a secondary line is overloaded and the output voltage drops by 30 to 40% of the normal voltage, this short-circuit protection circuit will be activated.

### **1.7.7 Overvoltage protection circuit**

The harmonic suppression circuit (active filter circuit) and the main power circuit are respectively equipped with an overvoltage protection circuit. If the voltage between both ends of C911 rises by 10% of the normal voltage, or if the voltage of the main power secondary output line rises by 30 to 40% of the normal voltage, operations of IC901 and IC902 will be stopped.

## 1.8 Adjustment

### 1.8.1 Adjustment mode

This monitor has the following adjustment modes.

- (1) User mode (Normal mode)
- (2) Factory mode (Factory adjustment mode)

### 1.8.2 User mode (Normal mode)





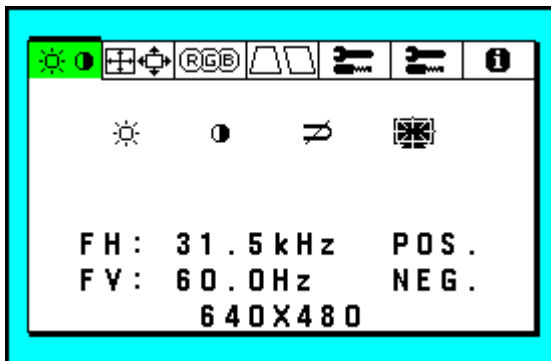

















This is the mode user executing the adjustment and setting. When pressing button of EXIT, (<), (>), (-), (+) and SELECT on the front panel, the following menu picture is displayed on the screen.























The adjusted data in the user mode is memorized to EEPROM automatically.



The adjustment group can be selected with (<), (>), (-) and (+) buttons. (+) and (-) buttons have the functions of the variable of the adjustment value. The items can be adjusted in the user mode are as following table.

## OSM menu (User mode)

Group icon	Item icon	Item	Adjustment		
			-	+	
 Group 1		BRIGHTNESS	To decrease the brightness.	To increase the brightness.	
		CONTRAST	To decrease the contrast.	To increase the contrast.	
		DEGAUSS	N/A	To eliminate possible color shading or impurity.	
		CONSTANT BRIGHTNESS	N/A	Activates the constant brightness function.	
		RESET	Restore to factory preset level with RESET button.		
 Group 2		AUTO ADJUST	N/A	To adjust the screen size automatically based on input timing.	
		LEFT / RIGHT	To move the image to the left.	To move the image to the right.	
		DOWN / UP	To move the image down.	To move the image up.	
		NARROW / WIDE	To narrow the width of the image on the screen.	To expand the width of the image on the screen.	
		SHORT / TALL	To narrow the height of the image on the screen.	To expand the height of the image on the screen.	
		RESET	Restore to factory preset level with RESET button.		
 Group 3	<b>1 2 3</b> <b>sRGB5</b>	COLOR TEMPERATURE ADJUSTMENT (9300K, 8200K, 7500K, SRGB, 5000K)		N/A	N/A
	For each color temperature		COLOR TEMPERATURE	To decrease the color temperature.	To increase the color temperature.
		<b>R</b>	RED	To decrease the red color.	To increase the red color.
		<b>G</b>	GREEN	To decrease the green color.	To increase the green color.
		<b>B</b>	BLUE	To decrease the blue color.	To increase the blue color.
	RESET	Restore to factory preset level with RESET button.			
 Group 4		IN / OUT (PIN CUSHION)	Forms a pin.	Forms a barrel.	
		LEFT / RIGHT (PIN CUSHION BALANCE)	Distorts the screen leftward.	Distorts the screen rightward.	
		TILT (PARALLELOGRAM)	Distorts the upper section leftward.	Distorts the upper section rightward.	
		ALIGN (TRAPEZOIDAL)	Narrows the upper section.	Narrows the lower section.	
		ROTATE (RASTER ROTATION)	To rotate the image counterclockwise.	To rotate the image clockwise.	
		TOP	The upper section forms a pin.	The upper section forms a barrel.	
		TOP-BALANCE	Distorts the upper section leftward.	Distorts the upper section rightward.	
		BOTTOM	The lower section forms a pin.	Lowers the lower section.	
		BOTTOM-BALANCE	Distorts the lower section leftward.	Distorts the lower section rightward.	
		RESET	Restore to factory preset level with RESET button.		

Group icon	Item icon	Item	Adjustment	
			-	+
 Group5		MOIRE CLEAR	Reduces the moire value.	Increases the moire value.
		CONVERGENCE (HOR.)	The red moves to the left side of the green.	The red moves to the right side of the green.
		CONVERGENCE (VER.)	The red moves below the green.	The red moves above the green.
		LINEARITY (VER.)	Contracts the center area.	Elongates the center area.
		VERTICAL BALANCE	Elongates the lower section of the screen.	Elongates the upper section of the screen.
		GLOVAL SYNC (TL)	The green screen will be reddish.	The green screen will be bluish.
		GLOBAL SYNC (TR)	The green screen will be reddish.	The green screen will be bluish.
		GLOBAL SYNC (BL)	The green screen will be reddish.	The green screen will be bluish.
		GLOBAL SYNC (BR)	The green screen will be reddish.	The green screen will be bluish.
		GLOBAL SYNC (L / R)	The both side of the screen will be reddish.	The both side of the screen will be bluish.
		RESET	Restore to factory preset level with RESET button.	
	 Group 6		LANGUAGE	Selects the left items.
		OSM POSITION	C→BR→BL→TR →TL	C→TL→TR→BL→ BR
		OSM TURN OFF	Reduces the time.	Increases the time.
		OSM LOCK OUT	N/A	Turns ON (+: SELECT key)
		IPM OFF MODE	ON	OFF
		EDGE LOCK	FRONT	BACK
		HOT KEY	ON	OFF
		FACTORY PRESET	N/A	Restores all items to the factory preset level.
		RESET	Restore to factory preset level with RESET button.	
 Group 7	MODE	DISPLAY MODE	N/A	N/A
		MONITOR INFO	N/A	N/A
	Hz 	REFRESH NOTIFIER	ON	OFF
		RESET	Restore to factory preset level with RESET button.	

\* Reset: Select an adjustment item and press the RESET key, then, it restores to factory preset level.



### 1.8.3 Factory mode

This mod can adjust all of items, and also change the factory default adjustment data (reset data).

#### 1.8.3.1 How to entering to Factory mode

The setting of the factory mode is executed by the following procedures.

(1) Power ON with EXIT button pressed, and confirm that the following OSM picture appears.

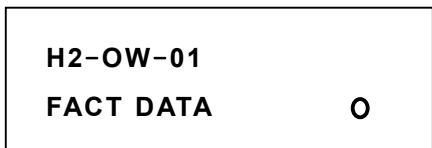

- (3) Press (-) button once to set the data value to 255.
- (4) Press (+) button to set the data value to 5.
- (5) Press SELECT button to move to the factory mode.
- (6) As shown below, the adjustment data (hexadecimal number) and the adjustment group of FAC1, FAC2 and FAC3.

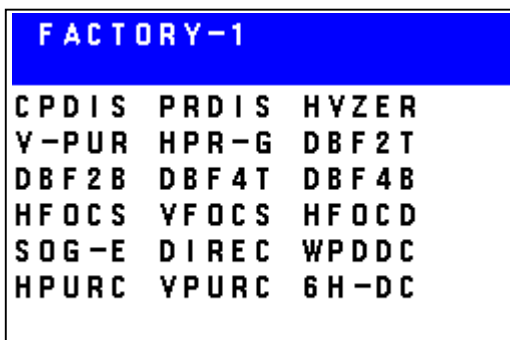

#### 1.8.3.2 How to cancel Factory mode

Follow the procedure below to cancel the factory mode:

(1) Using the (>) button, select the FAC3 group, and then press the (>) button again. The following OSM picture will appear.

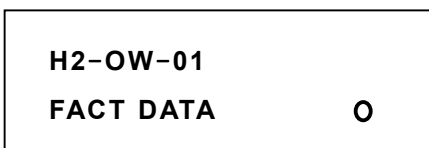

- (2) Press the (+) or (-) button to set the data value to '10'.
- (3) Press the (SELECT) button. The factory mode will be canceled.

#### 1.8.3.3 How to enter FACTORY-HV mode

Follow the procedure below to enter the FACTORY-HV mode:

(1) Using the (>) button, select the FAC3 group, and then press the (>) button again. The following OSM picture will appear.

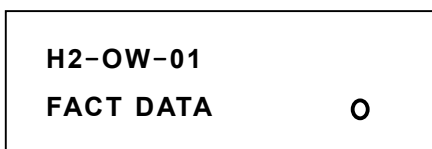

(2) Press the (-) button to set the data value to '250'.

(3) Press the (SELECT) key to enter the FACTORY-HV mode.



(4) Press the (>) or (<) button. The FACTORY-HV mode will be canceled.

## 2. Adjustment procedure

### 2.1 Measuring instruments

- |   |   |
|---|---|
| (1) Signal generator A:                           | Astro Design VG-812 or equivalent           |
| (2) Signal generator B:                           | Astro Design VG-829 or equivalent           |
| (3) DC voltmeter:                                 | 150V 0.5 Class or digital voltmeter         |
| (4) High voltage meter:                           | 0.5 Class that can measure 40KV             |
| (5) Luminance meter:                              | Minolta color analyzer CA-100 or equivalent |
| (6) AC voltmeter:                                 | 150V/300V 0.5 Class or equivalent           |
| (7) Oscilloscope:                                 | Scope with band of 100MHz or more           |
| (8) Landing measuring device:                     | Felmo product                               |
| (9) Double scale:                                 | For width and distortion measurement        |
| (10) Withstand voltage meter:                     | Kikusui Model TOS8650 or equivalent         |
| (11) Grounding conductivity measuring instrument: | CLARE U.K. product                          |
| (12) Convergence meter:                           | MINOLTA CC-100                              |

### 2.2 Preparatory inspections

- (1) There must be no cracks or remarkable contamination on the PWB.
- (2) There must be no remarkable lifting or inclination of the parts on the PWB, and the parts must not be touching.
- (3) The connectors must be securely inserted without crimping faults.
- (4) The CRT socket, anode cap and focus lead must be securely mounted.
- (5) The lead wires must not be pressed against the edges of the board.
- (6) The lead wires must not touch the high temperature parts such as the R-METAL, R-CEMENT or TR with FIN.
- (7) The board must not be bent, remarkably contaminated or scratched.
- (8) The CRT has no scratch or chipping.
- (9) Each potentiometer must turn smoothly.
- (10) Always set each potentiometer to the following positions before turning the power ON.

Potentiometer default settings

PWB name	IC sources	Name (symbol)	Default adjustment position	Remarks
PWB-MAIN	VR5A1	H-POSI	Center	
		FOCUS1	Center	FBT
		FOCUS2	Center	FBT
		SCREEN	Completely counterclockwise	FBT

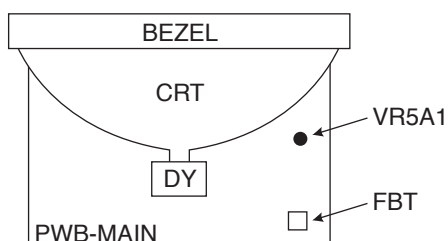

\* look at inside of the monitor from upper side.

## 2.3 Names of each monitor part

### 2.3.1 Configuration of front control panel

- a : Power button
- b : Power indicator
- c : EXIT button
- d : CONTROL (Item select) buttons
- e : CONTROL (Adjust) buttons
- f : SELECT / SB MODE button
- g : RESET/ INPUT SELECT button

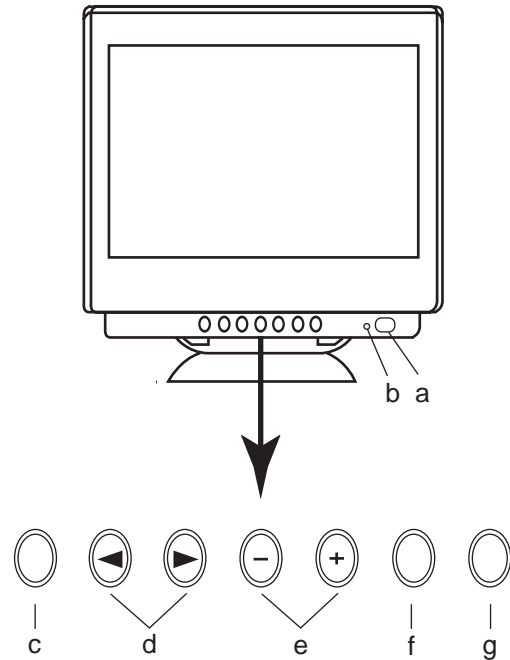
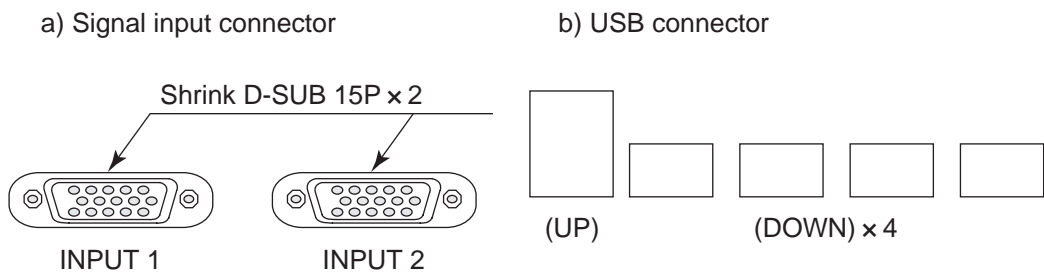

Figure 1 Front control panel

### 2.3.2 Configuration of rear input connector (signal input)



## 2.3.3 OSM display matrix

### 2.3.3.1 User mode

Adjustment items	Setting contents	Default setting	Setting classification	
			By timings	Common
<b>OSM group USER1</b>				
BRIGHTNESS	0.0 ~ 100.0%	30.1%		
CONTRAST	0.0 ~ 100.0%	100.0%		
DEGAUSS	< + >			
CONSTANT BRIGHTNESS	< + >			
<b>OSM group USER2</b>				
AUTO-ADJUST	< + >			
LEFT/RIGHT	0.0 ~ 100.0%			
DOWN/UP	0.0 ~ 100.0%	50%		
NARROW/WIDE	0.0 ~ 100.0%			
SHORT/TALL	0.0 ~ 100.0%			
<b>OSM group USER3</b>				
COLOR	COLOR1,2,3,sRGB,5	COLOR1		
COLOR TEMP1,2,3,5	5000K-9300K	COLOR1:9300K		
RED (GAIN)1,2,3,5	0.0 ~ 100.0%			
GREEN (GAIN)1,2,3,5	0.0 ~ 100.0%			
BLUE (GAIN)1,2,3,5	0.0 ~ 100.0%			
<b>OSM group USER4</b>				
IN/OUT	0.0 ~ 100.0%			
LEFT/RIGHT	0.0 ~ 100.0%			
TILT	0.0 ~ 100.0%			
ALIGN	0.0 ~ 100.0%			
ROTATE	0.0 ~ 100.0%	Adjustment value		
TOP	0.0 ~ 100.0%			
TOP BALANCE	0.0 ~ 100.0%			
BOTTOM	0.0 ~ 100.0%			
BOTTOM BALANCE	0.0 ~ 100.0%			
<b>OSM group USER5</b>				
MOIRE CANCELER	0.0 ~ 100.0%	0.0%		
CONVERGENCE(HOR.)	0.0 ~ 100.0%	Adjustment value(16.8 ~ 82.7%)		
CONVERGENCE(VER.)	0.0 ~ 100.0%	Adjustment value(16.8 ~ 82.7%)		
LINEARITY(VER.)	0.0 ~ 100.0%			
VERTICAL BALANCE	0.0 ~ 100.0%			
GLOBAL SYNC(TL)	0.0 ~ 100.0%	Adjustment value(21.9 ~ 77.6%)		
GLOBAL SYNC(TR)	0.0 ~ 100.0%	Adjustment value(21.9 ~ 77.6%)		
GLOBAL SYNC(BL)	0.0 ~ 100.0%	Adjustment value(21.9 ~ 77.6%)		
GLOBAL SYNC(BR)	0.0 ~ 100.0%	Adjustment value(21.9 ~ 77.6%)		
GLOBAL SYNC(LR)	0.0 ~ 100.0%	Adjustment value		
<b>OSM group USER6</b>				
LANGUAGE	ENG/DEU/FRA/ESP/ITA/JPN	ENG		
OSM POSITION	< - / + >	(OSM is at the center of picture)		
OSM TURN OFF	5SEC ~ 120SEC	45SEC		
OSM LOCK OUT	ON/OFF	OFF		
IPM OFF MODE	ENABLE/DISABLE	ENABLE		
EDGE LOCK	FRONT/BACK	BACK		
HOT KEY	OFF/ON	OFF		
FACTORY PRESET	< + >			
<b>OSM group USER7</b>				
DISPLAY MODE				
MONITOR INFO		DPro2070SB		
REFRESH NOTIFIER	OFF/ON	OFF		

### 2.3.3.2 Factory mode

Adjustment items	Setting contents	Default setting	Setting classification	
			By timings	Common
<b>OSM group USER1</b>				
BRIGHTNESS	0.0 ~ 100.0%	30.1%		
CONTRAST	0.0 ~ 100.0%	100.0%		
DEGAUSS	<+>			
CONSTANT BRIGHTNESS	<+>			
<b>OSM group USER2</b>				
AUTO-ADJUST	<+>			
LEFT/RIGHT	0.0 ~ 100.0%			
DOWN/UP	0.0 ~ 100.0%	50%		
NARROW/WIDE	0.0 ~ 100.0%			
SHORT/TALL	0.0 ~ 100.0%			
<b>OSM group USER3</b>				
COLOR	---			
COLOR TEMP1,2,3,5	---			
R GAIN1,2,3,5	---			
G GAIN1,2,3,5	---			
B GAIN1,2,3,5	---			
<b>OSM group USER4</b>				
IN/OUT	0.0 ~ 100.0%			
LEFT/RIGHT	0.0 ~ 100.0%			
TILT	0.0 ~ 100.0%			
ALIGN	0.0 ~ 100.0%			
ROTATE	0.0 ~ 100.0%	Adjustment value		
TOP	0.0 ~ 100.0%			
TOP BALANCE	0.0 ~ 100.0%			
BOTTOM	0.0 ~ 100.0%			
BOTTOM BALANCE	0.0 ~ 100.0%			
PCC CENTER	0.0 ~ 100.0%			
PCC SINE	0.0 ~ 100.0%			
<b>OSM group USER5</b>				
MOIRE CANCELER	0.0 ~ 100.0%	0.0%		
CONVERGENCE(HOR.)	16.8 ~ 82.7%	Adjustment value		
CONVERGENCE(VER.)	16.8 ~ 82.7%	Adjustment value		
LINEARITY(VER.)	0.0 ~ 100.0%			
VERTICAL BALANCE	0.0 ~ 100.0%			
GLOBAL SYNC(TL)	21.9 ~ 77.6%	Adjustment value		
GLOBAL SYNC(TR)	21.9 ~ 77.6%	Adjustment value		
GLOBAL SYNC(BL)	21.9 ~ 77.6%	Adjustment value		
GLOBAL SYNC(BR)	21.9 ~ 77.6%	Adjustment value		
GLOBAL SYNC(LR)	0.0 ~ 100.0%	Adjustment value		
<b>OSM group USER6</b>				
LANGUAGE	ENG/DEU/FRA/ESP/ITA/JPN	ENG		
OSM POSITION	<- /+>	(OSM is at the center of picture)		
OSM TURN OFF	5SEC ~ 120SEC	45SEC		
OSM LOCK OUT	---	OFF		
IPM OFF MODE	ENABLE/DISABLE	ENABLE		
EDGE LOCK	FRONT/BACK	BACK		
HOT KEY	OFF/ON	OFF		
FACTORY PRESET	< + >			
<b>OSM group USER7</b>				
DISPLAY MODE				
MONITOR INFO		DPro2070SB		
REFRESH NOTIFIER	OFF/ON	OFF		
DESTINATION	USA/EUR/JPN	USA		

Adjustment items		Setting contents	Default setting	Setting classification	
				By timings	Common
<b>FACT 1</b>					
C-PURITY-DIS	CPDIS	0(OFF)/1(ON)	1(ON)		
PURITY-DIS	PRDIS	0(OFF)/1(ON)	1(ON)		
MAG-ZERO-HV	HVZER	PRO(Eeh)			
V-CANCEL	V-PUR	000 ~ 0FF			
H-CANCEL	HPR-G	000 ~ 0FF			
DBFV2 TOP	DBF2T	000 ~ 7F			
DBFV2 BOTTOM	DBF2B	000 ~ 7F			
DBFV4 TOP	DBF4T	000 ~ 7F			
DBFV4 BOTTOM	DBF4B	000 ~ 7F			
DBF-H-AMP	HFOCS	000 ~ 0FF			
DBF-V-AMP	VFOCS	000 ~ 7F			
DBF-H-PHASE	HFOCD	000 ~ 64			
SYNC-ON-GREEN	SOG-E	0(OFF)/1(ON)	1(ON)		
DIRECT-KEY	DIREC	0(OFF)/1(ON)	1(ON)		
DDC-EEP-WP	WPDDC	0(Unwritable)/1(Writable)	0(Unwritable)		
H PURITY CHECK	HPURC	000 ~ 002	0		
V PURITY CHECK	VPURC	000 ~ 002	0		
DDCP-6H-DC		000 ~ 0FF			
<b>FACT 2</b>					
YHTT	YH-TT	000 ~ 0FF			
YHTB	YH-TB	000 ~ 0FF			
YHJT	YH-JT	000 ~ 0F1			
YHJB	YH-JB	000 ~ 0F1			
XH-L	XH-L	000 ~ 0FF			
XH-R	XH-R	000 ~ 0FF			
PQH-TL	PQH-TL	000 ~ 0FF			
PQH-TR	PQH-TR	000 ~ 0FF			
PQH-BL	PQH-BL	000 ~ 0FF			
PQH-BR	PQH-BR	000 ~ 0FF			
S3H-TL	S3H-TL	000 ~ 0FF			
S3H-TR	S3H-TR	000 ~ 0FF			
S3H-BL	S3H-BL	000 ~ 0FF			
S3H-BR	S3H-BR	000 ~ 0FF			
YVTT	YV-TT	000 ~ 0FF			
YVTB	YV-TB	000 ~ 0FF			
YVJT	YV-JT	000 ~ 0FF			
YVJB	YV-JB	000 ~ 0FF			
XV-L	XV-L	000 ~ 0FF			
XV-R	XV-R	000 ~ 0FF			
PQV-TL	PQV-TL	000 ~ 0FF			
PQV-TR	PQV-TR	000 ~ 0FF			
PQV-BL	PQV-BL	000 ~ 0FF			
PQV-BR	PQV-BR	000 ~ 0FF			
S3V-TL	S3V-TL	000 ~ 0FF			
S3V-TR	S3V-TR	000 ~ 0FF			
S3V-BL	S3V-BL	000 ~ 0FF			
S3V-BR	S3V-BR	000 ~ 0FF			
<b>FACT 3</b>					
R-BIAS-H	R-BS1	000 ~ 0FF			
G-BIAS-H	G-BS1	000 ~ 0FF			
B-BIAS-H	B-BS1	000 ~ 0FF			
R-BIAS-M	R-BS2	000 ~ 0FF			
G-BIAS-M	G-BS2	000 ~ 0FF			
B-BIAS-M	B-BS2	000 ~ 0FF			
R-BIAS-L	R-BS3	000 ~ 0FF			
G-BIAS-L	G-BS3	000 ~ 0FF			
B-BIAS-L	B-BS3	000 ~ 0FF			





## 2.4 Adjustment

### 2.4.1 How to select the factory adjustment (FACTORY) mode

#### 2.4.1.1 Selecting with front panel switches

- (1) Turn the power ON while holding down EXIT button.
- (2) After step (1), release EXIT button after one to two seconds.
- (3) Confirm that 255 is displayed for the counter of FACT DATA on OSM display.
- (4) Set to 05 with (+) button.
- (5) When SELECT / SB MODE button is pressed, the factory mode will be entered.

This factory adjustment mode is entered with the above steps.

\*The factory adjustment mode remains valid even after the power is turned OFF.

Note that steps (3) to (4) must be carried out within ten seconds. If ten seconds are exceeded, the mode will return to the user mode.

#### <Returning to the user mode from the factory mode>

- (1) Display FACT DATA on OSM picture with the group selection.
- (2) Set the counter value to 010 with (-) (+) buttons.
- (3) When SELECT / SB MODE button is pressed, the mode will return to the user mode.

### 2.4.2 Adjustments before aging

Status indicator	Adjustment item	Adjustment mode/set	Input signal/pattern
	Before aging		The only the sync. signal of No. 12:106.25kHz / 85Hz, 1600x1200

#### 2.4.2.1 Adjusting the high voltage and high voltage protector

Status indicator	Adjustment item	Adjustment mode/set	Input signal/pattern
	High voltage and high voltage protector		The only the sync. signal of No. 12:106.25kHz / 85Hz, 1600x1200

(Timing No. 12 (106.25 kHz/85 Hz, 1600x1200) SYNC signal is only input)

- (1) Turn the monitor power OFF and connect a high voltage indicator to the anode of CRT before turning the monitor power ON.
- (2) Select "FACT DATA\*\*\*\*" on OSM and set to 250 using (-) button before pushing the SELECT / SB MODE button.
- (3) Select HVADJ (HV-ADJ CAUTION) on OSM to adjust the high voltage to 27.0kV±0.5kV.
- (4) Select XPCAL (XPRO-CALIBRATION) on OSM and turn the screen VR all the way down counterclockwise before adjusting the high voltage to 31.0kV±0.5kV by manipulating (+) (-) buttons.
- (5) With SELECT / SB MODE button pushed, the protector operation point is set, causing the high voltage to return to 27.0kV±0.5kV.
- (6) Rotate the screen VR so that OSM can be confirmed.
- (7) Select XPROT (XPRO-TST CAUTION) on OSM by the manipulation shown above and turn the screen VR all the way down counter-clockwise.
- (8) Raise the voltage manipulating (+) button and make sure that the high-voltage protection circuit gets activated at 31.0kV±0.5kV.

#### 2.4.2.2 FOCUS adjustment (Rough adjustment)

- (1) Set the brightness so that the raster can be confirmed with the screen VR (FBT).
- (2) Adjust the focus pack "FOCUS 1, 2" so that both edges of the picture are clear.

#### 2.4.2.3 Shock test

- (1) Display the "color bar" with the signal generator A.
- (2) Confirm that there is no abnormality in the image when shock is applied on the monitor.

#### 2.4.2.4 Preadjustment before aging

- (1) Change to FACTORY MODE (aging mode) in advance.
- (2) Display a full white with the signal generator A.
- (3) Confirm that the R, G and B channel images are output.
- (4) Confirm that the picture position, picture size, PCC and balance can be controlled, and roughly adjust.

- (5) Adjustment of BTCEN (BRIGHT-CENT), BTMAX (BRIGHT-MAX), BS1 (BIAS-H)
  - a) Input timing No. 12 (1600x1200 106.25K/85) with the signal generator (R, G and B OFF).

- b) Set each adjustment item to the following value.

BRIGHTNESS : 7F  
(FACT3)  
R-BS1(R-BIAS-H) : 00  
G-BS1(G-BIAS-H) : 8A  
B-BS1(B-BIAS-H) : 00  
BTCEN (BRIGHT-CENT) : 5E0  
BTMAX (BRIGHT-MAX) : 800

- c) Connect PWB-CRT TP (R200G lead wire) to the probe.
- d) Select BTCEN (BRIGHT-CENT) in FACT3, set the black level voltage of PWB-CRT TP (R200G lead wire) to  $70 \pm 0.5V$  with the oscilloscope (refer to the following picture).  
\* In use of the digital voltage meter, set it to  $73 \pm 0.5V$ .

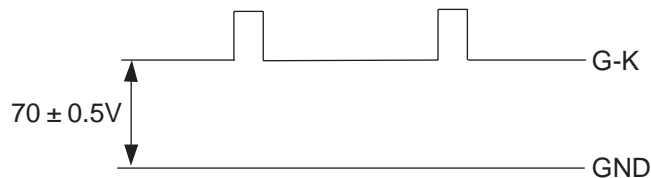

- e) Set the back raster luminance to  $0.5 \pm 0.3 \text{ cd/cm}^2$  with BRIGHTNESS adjustment.
  - f) Adjust the back raster color coordination to the following value with R-BS1 (R-BIAS-H) and B-BS1 (B-BIAS-H).  
x:  $0.283 \pm 0.02$  / y:  $0.297 \pm 0.02$   
\* Do not adjust BTCEN (BRIGHT-CENT) after the adjustment of back raster color coordination carried out at f) above, but it can be adjusted in main adjustment mentioned after 2.4.3.  
\* BRIGHTNESS should be adjusted when the back raster is varied in adjustment of purity and convergence.
- (6) Confirm that OSM power management is OFF.
  - (7) Disconnect the signal and confirm that the following picture appears on OSM. Then adjust OSM picture luminance with BRIGHTNESS adjustment, and carry out heat run for 60 minutes or more.

OWN	VER
H2-OWS.**	2.*.**
(Initial data file name)	

### 2.4.2.5 Adjusting the landing (ITC/4 corner purity adjustment)

Status indicator	Adjustment item	Adjustment mode/set	Input signal/pattern
	landing		No. 12:106.25kHz / 85Hz, 1600x1200
			Full green

- Input the timing No. 12 (106.25kHz/85Hz, 1600x1200) full green signal.
- Turn OFF the monitor power to carry out hand degaussing.
- Select GLOBAL SYNC (TL) on OSM.
- Adjust to the best condition using (-) (+) buttons. Here, make sure that the adjusted value is within the range of OSM display value = 2Ah (42) to D5h (213).
- Carry out similar adjustment for TR/BL/BR (GLOBAL SYNC).

Note) When the substrate is replaced at the time of repair, set TL/TR/BL/BR to the values before replacement before carrying out adjustment.

- Input the timing No.12 (106.25kHz/85Hz, 1600x1200) full white signal.

### 2.4.3 Adjusting the picture size, position, distortion, DBF amplitude and phase

The manual adjustment methods are explained below. The adjustments are executed in the factory adjustment (factory) mode.

Adjust the picture size to the value indicated in the list of adjustment values.(Refer to 2.5.1.10 Adjustment value list.)

Adjust the distortion to the value indicated in the picture performance inspection item. (Refer to 2.5.1.8 Picture distortion.)

#### 2.4.3.1 Adjusting the picture inclination

Status indicator	Adjustment item	Adjustment mode/set	Input signal/pattern
	Picture inclination	Factory	No. 12:106.25kHz / 85Hz, 1600x1200
			Crosshatch with frame

Set OSM to ROTATE, and using (-) (+) buttons, set the raster inclination to be horizontal to the CRT face surface.

#### 2.4.3.2 Adjusting the back raster position

Status indicator	Adjustment item	Adjustment mode/set	Input signal/pattern
	Back raster position	Factory	No. 12:106.25kHz / 85Hz, 1600x1200
			Only the sync. signal input

- Set BRIGHTNESS to 100% to show the back raster.
- Adjust the horizontal back raster position to the center of the bezel using VR5A1(H-POSI). At this time, the raster width should be  $L1-L2 = 3.0 \pm 1.0\text{mm}$ .

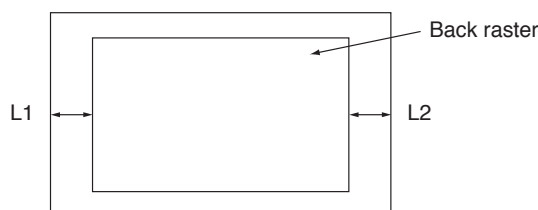

### 2.4.3.3 Adjusting the left/right distortion, picture width, picture position (LEFT/RIGHT) and vertical linearity (all preset)

- (1) Set DOWN/UP of the user mode to 50%.

<Setting in the factory mode with the following steps>

- (2) Adjust the vertical size to approx. 297mm, and the vertical position to the approximate center.
- (3) Select LINEARITY (VER.) and VERTICAL BALANCE with OSM, and adjust so that the vertical linearity is equal at the very top of the picture, at the very bottom of the picture, and at the center of the picture.
- (4) Select SHORT/TALL and DOWN/UP with OSM, and adjust the vertical width and vertical position to the specified values using (-) (+) buttons.
- (5) Select IN/OUT, ALIGN, PCC CENTER, TOP and BOTTOM with OSM, and adjust the vertical line at both side of the picture to the straight line using (-) (+) buttons.
- (6) If the left and right distortions differ, select LEFT/RIGHT (PIN VAL), TILT, TOP-BALANCE and BOTTOM-BALANCE with OSM, and adjust so that the distortions are visually balanced.
- (7) Select LEFT/RIGHT with OSM, and adjust the horizontal raster position to the center of the picture using (-) (+) buttons.
- (8) Select NARROW/WIDE with OSM, and adjust the horizontal raster width to the value given in the adjustment list using using (-) (+) buttons. (Refer to 2.5.1.10 Adjustment value list.)

\*Note (1) PCC SINE, LEFT/RIGHT (PIN VAL) and PCC CENTER are used only for touch up.

Note (2) The picture position and distortion must be within the ranges given in the picture performance inspection items. (Refer to 2.5.1.8 Picture distortion.)

### 2.4.3.4 Adjusting the DBF amplitude and phase

- (1) Connect the oscilloscope to the lead of R7A2 (SG702 side) on PWB-MAIN and to one of the signal outputs for the signal sources full R, G, B (VIDEO).
- (2) Set OSM to the select picture of HFOCUS (DBF-H-AMP) in FACT 1, and using (-) (+) buttons adjust the horizontal parabola wave amplitude (image area) to the value given in the list of adjustment values. (Refer to 2.5.1.10 Adjustment value list.)

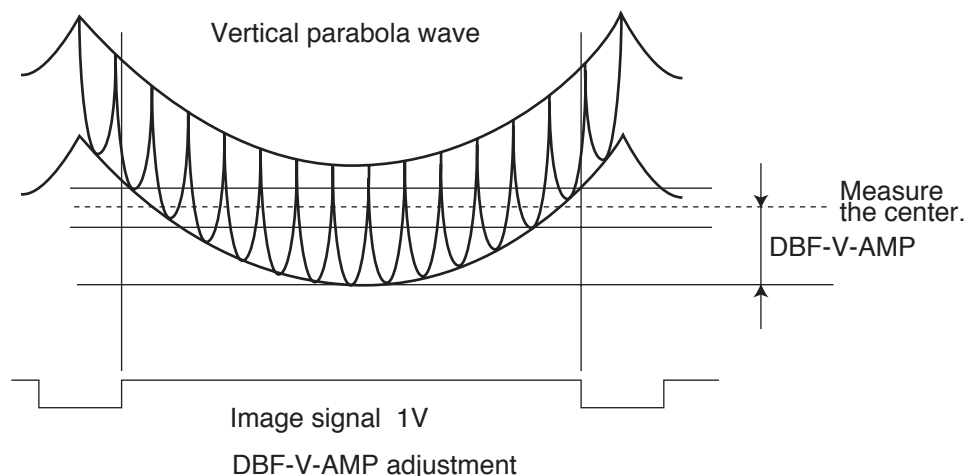

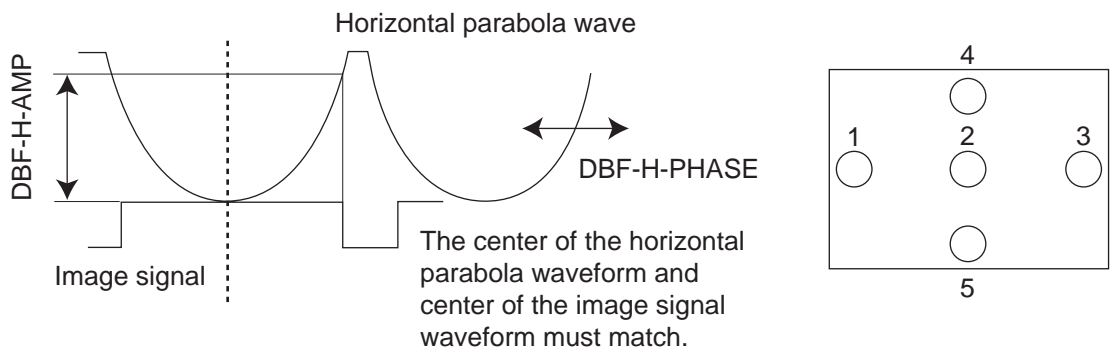

#### DBF-H-AMP / PHASE adjustment

- (3) Set the output of the signal generator to crosshatch (white/normal).
  - (4) Set OSM to the select picture of HFOCD (DBF-H-PHASE) in FACT1, and adjust the focus balance of point 1 and point 3 in the above figure using (-) (+) buttons.
- \* (3) and (4) should be carried out with all preset timing.
- (5) Set OSM to the select picture of DBF2T (DBFV2 TOP) in FACT1, and adjust using (-) (+) buttons so that the focus level of point 4 and point 2 in the above figure can be balanced.
  - (6) Set OSM to the select picture of DBF2B (DBFV2 BOTTOM) in FACT1, and adjust using (-) (+) buttons so that the focus level of point 2 and point 5 in the above figure can be balanced.
- \* (5) and (6) should be carried out with timing No. 12 (106.25kHz/85Hz, 1600x1200).

#### 2.4.4 Adjusting the cut off

Status indicator	Adjustment item	Adjustment mode/set	Input signal/pattern
	Cut off	Factory	No. 12:106.25kHz / 85Hz, 1600x1200

##### 2.4.4.1 Adjusting BTCEN (BRIGHT-CENT), BTMAX (BRIGHT-MAX) and BS1 (BIAS-H)

<In case pre-adjustment before aging is carried out >

- (1) Input timing No. 12 (106.25kHz/85Hz, 1600x1200) with the signal generator (R, G and B OFF).
- (2) Set each adjustment item to the following value.
 

BRIGHTNESS (FACT3)	: 7F
R-BS1(R-BIAS-H)	: 00
G-BS1(G-BIAS-H)	: 8A
B-BS1(B-BIAS-H)	: 00
BTMAX (BRIGHT-MAX)	: 800
- (3) Set the back raster luminance to 0.3 +/- 1cd/m<sup>2</sup> with FBT screen VR.
- (4) Adjust the back raster color coordination to the value listed in the following table with R-BS1 (R-BIAS-H) and B-BS1 (B-BIAS-H).
- (5) Adjust the back raster luminance to 0.3 +/- 0.1cd/m<sup>2</sup> with BTCEN.
- (6) If the back raster color coordination is deviated from the values listed in the following table, repeat steps (4) and (5).
- (7) Adjust the back raster luminance to 3.0 +/- 0.2cd/m<sup>2</sup> with BTMAX.

<In case pre-adjustment before aging is not carried out >

(1) Input timing No. 12 (106.25kHz/85Hz, 1600x1200) with the signal generator (R, G and B OFF).

(2) Set each adjustment item to the following value.

BRIGHTNESS : 7F  
 (FACT3)  
 R-BS1(R-BIAS-H) : 00  
 G-BS1(G-BIAS-H) : 8A  
 B-BS1(B-BIAS-H) : 00  
 BTCEN (BRIGHT-CENT) : 5E0  
 BTMAX (BRIGHT-MAX) : 800

(3) Connect PWB-CRT TP (R200G lead wire) to the probe.

(4) Select BTCEN (BRIGHT-CENT) in FACT3, set the black level voltage of PWB-CRT TP (R200G lead wire) to 70 +/- 0.5V with the oscilloscope (refer to the following picture).

\* In use of the digital voltage meter, set it to 73 +/- 0.5V.

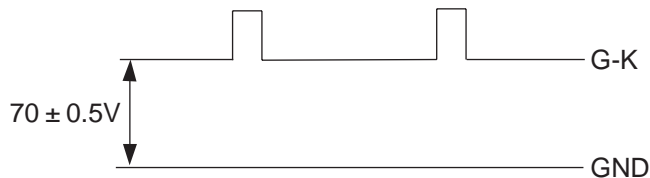

(5) Set the back raster luminance to 0.3 +/- 1cd/m<sup>2</sup> with FBT screen VR.

(6) Adjust the back raster color coordination to the value listed in the following table with R-BS1 (R-BIAS-H) and B-BS1 (B-BIAS-H).

(7) Adjust the back raster luminance to 0.3 +/- 0.1cd/m<sup>2</sup> with BTCEN.

(8) If the back raster color coordination is deviated from the values listed in the following table, repeat steps (6) and (7).

(9) Adjust the back raster luminance to 3.0 +/- 0.2cd/m<sup>2</sup> with BTMAX.

\* The following table is applicable for the monitor without the back cover.

Adjustment value of BS1 (BIAS-H)

Adjustment item		BS1 (BIAS-H)
Color temperature		(9300K)
Color coordination	x	0.283±0.015
	y	0.297±0.015

#### 2.4.4.2 Adjusting BS2 (BIAS-M) / BS3 (BIAS-L)

(1) Set R-BS2 (R-BIAS-M), G-BS2 (G-BIAS-M) and B-BS2 (B-BIAS-M) to the value listed in the following table.

(2) Set R-BS3 (R-BIAS-L), G-BS3 (G-BIAS-L) and B-BS3 (B-BIAS-L) to the value listed in the following table.

As the values listed in the following table are the finite differences from the values of BS1 (BIAS-H), this adjustment should be carried out after adjustment of BS1 (BIAS-H).

Adjustment data of BS2 (BIAS-M) / BS3 (BIAS-L)

(\*The following data is the finite difference from BS 1 (BIAS-H).)

Adjustment item		BS2 (BIAS-M)	BS3 (BIAS-L)
Color temperature		(6500K)	(5000K)
Data	R-BS	+3	+5
	G-BS	same value	same value
	B-BS	-4	-8

## 2.4.5 Setting CONSTANT BRIGHTNESS circuit (Factory mode)

Note) This operation should be carried out after the adjustment of cut-off. In addition, heat-running should be fully carried out.

### 2.4.5.1 Reading beam current default data

- (1) Input timing No. 12 (106.25kHz/85Hz, 1600x1200) crosshatch signal with the signal generator.
- (2) Select CONSTANT BRIGHTNESS and push (-) button, then it starts to read the beam current default data.
- (3) When the reading is completed, OSM standard voltage DAC (Digital Analog Converter) data and the beam current default data of each color (R/G/B) are indicated. Then, confirm that the data is within the following value range.

Standard voltage DAC data : 50-F0 (HEX)

Red beam current default data : 73-8C (HEX)

Green beam current default data : 73-8C (HEX)

Blue beam current default data : 73-8C (HEX)

- (4) If the above data could not be within the value range specified in (3) above, carry out steps (2) and (3) mentioned above once.
- (5) Measure the luminance and color coordination of the back raster.

### 2.4.5.2 Confirming CONSTANT BRIGHTNESS function

- (1) Select COSTANT BRIGHTNESS. Push (+) button, and it decrements the BRIGHTNESS data to imitate the deteriorated condition due to elapsed time, then compensation function starts to operate.
- (2) Measure the color coordination and luminance of the back raster after compensation. Compare them to the data measured in 2.4.5.1 (5) to confirm that the differences are within the following value range.

Color coordination of x and y : within +/- 0.020

Luminance : within +/- 0.05cd/m<sup>2</sup>

- (3) If the color coordination and luminance of the back raster could not be within the value range specified in (2) above, select CONSTANT BRIGHTNESS and push RESET button, then carry out step 2.4.5.1 (2) once.
- (4) Select CONSTANT BRIGHTNESS, and push RESET button.

## 2.4.6 Adjusting the RGB drive signal

### 2.4.6.1 Adjusting GN1 (GAIN-H) (adjustment of 9300K)

Status indicator	Adjustment item	Adjustment mode/set	Input signal/pattern
	GN1 (GAIN-H)	Factory	No. 12:106.25kHz / 85Hz, 1600x1200
			Full white

- (1) Input the following adjustment timing with the signal generator.  
Pattern: Full white (Input amplitude = 0.7Vp-p)  
Adjustment timing: No.12 (106.25kHz/85Hz, 1600x1200)
- (2) Select CONTRAST with OSM, and set to MAX using (+) button.
- (3) Select BRIGHTNESS, and set the data to 7F using (-) (+) buttons.
- (4) Output the solid color for the picture from Signal generator A, and input GREEN only.
- (5) Set G-GN1 (G-GAIN-H) with OSM, and adjust the luminance of full green picture to the specified value listed in the following table with (-) (+) buttons.
- (6) Input BLUE, RED and GREEN, and select B-GN1 (B-GAIN-H), R-GN1 (R-GAIN-H) and G-GN1 (G-GAIN-H) appropriately, then adjust each data to the specified value listed in the following table with (-) (+) buttons.
- (7) Confirm that the variation of the color coordination data of x and y is within +/- 0.015 when CONTRAST is set to 25cd/m<sup>2</sup> with OSM.



- (8) Adjust GN2 (GAIN-M) and GN3 (GAIN-L) to the specified value listed in the following table in the same manner as GN1 (GAIN-H).

COLOR TEMPERATURE	GN1 (GAIN-H)	GN2 (GAIN-M)	GN3 (GAIN-L)	TOLERANCE	
Color temperature	(9300K)	(6500K)	(5000K)		
Full green luminance	77.0	66.0	54.0	± 1.0	
Full White color coordination	x	0.283	0.313	0.345	± 0.005
	y	0.297	0.329	0.359	± 0.005
Full white luminance(cd/m <sup>2</sup> )	105 or more	90 or more	75 or more		

(9) Setting R/G/B MAX GAIN

Set the MAX GAIN value for the following formula to the following address (all setting values are indicated by HEX).

Firstly hexadecimal number should be converted to decimal number to be calculated, then the result figured out is return to hexadecimal numbers to be written into the applicable address.

How to write into address is described below.

MAX GAIN = MAX value of R/G/B GAIN adjustment value (\*1) x {1 + (MAX value of SBCN1, 2 (\*2) /FF)

Address (HEX): 89 (R-GAIN-MAX), 8a (G-GAIN-MAX), 8b (B-GAIN-MAX)

(\*1): MAX value of R/G/B GAIN adjustment value is the maximum one among R-GN1, G-GN1, B-GN1, R-GN2, G-GN2, B-GN2, R-GN3, G-GN3 and B-GN3 in OSM (FACTORY-3) adjusted according to the procedure (1) to (8) mentioned above.

(\*2): MAX value of SBCN1, 2 is the maximum one between SBCN1 and SBCN2 in OSM (FACTORY-3).

Note) All of (MAX GAIN), (MAX value R/G/B GAIN) and (SBCN1 and SBCN2) are indicated by hexadecimal number (HEX), the value is to be converted to the decimal number (DEC) first to be calculated, then, converted to the hexadecimal number (HEX).

<How to rewrite into address>

(a) Change to FACTORY MODE in advance.

(b) Set the counter of FACT DATA on OSM to 99 using (-) (+) buttons, and push SELECT button.

(c) Press either ( ◀ ) or ( ▶ ) button, and confirm that the following picture appears.

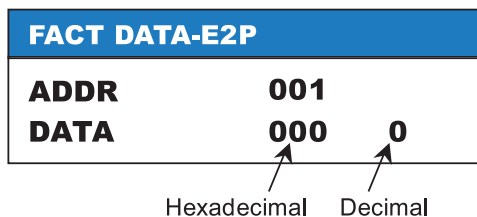

(d) Using (-) (+) buttons rewrite the counter for every hexadecimal data to the one figured out with the calculation mentioned above (decimal data is to be rewritten following to hexadecimal one synchronously).

(e) Press EXIT button, then the rewritten data is to be registered.

(f) To disable this rewriting function, turn the power OFF. However, FACTORY MODE is still alive even if the power was turned off.

**NOTE) Be careful NOT to wrongly rewrite the data since this rewriting function is available for all of the EDID data.**



### 2.4.6.2 Adjusting ABL

Status indicator	Adjustment item	Adjustment mode/set	Input signal/pattern
	ABL	Factory	No. 12:106.25kHz / 85Hz, 1600x1200
			Full white

(1) Input the following adjustment timing with the signal generator.

Pattern: Full white (input amplitude = 0.7Vp-p)

Adjustment timing: No.12 (106.25kHz/85Hz, 1600x1200)

(2) Select ABLAJ (ABL) with OSM, and adjust to 115cd/m<sup>2</sup> +/- 5.

Here, the picture size should follow 2.5.1.10 Adjustment value list.

### 2.4.7 Adjusting the focus

**NOTE) For adjustment of focus with FOCUS VR, be sure to use ISOLATED alignment driver.**

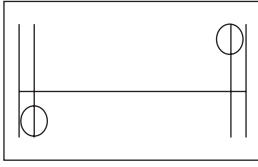
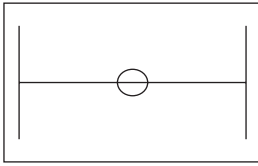
	Normal or reverse display	Point to align with
Vertical line	Reverse display (Green)	 <p>Adjust to FOCUS JUST at the circled sections using FBT FOCUS1-VR mainly and FBT FOCUS2-VR with well balancing.</p> <p>The ratio of core : Halo of the vertical lines at both sides should be 1 : 1.</p>
Horizontal line	Normal display	 <p>Adjust to FOCUS JUST at the center of screen (circled section) using FBT FOCUS1-VR mainly and FBT FOCUS2-VR with well balancing.</p> <p>Adjust to halo condition once, then adjust to FOCUS JUST.</p>

\* Adjust halo to a quarter of core with camera adjustment.

Halo should be a half of core maximum.

### <Adjusting the static focus>

Status indicator	Adjustment item	Adjustment mode/set	Input signal/pattern
	Static focus		No. 12:106.25kHz / 85Hz, 1600x1200
			H character, crosshatch

For steps (1) and (2), use the timing No. 12 (106.25kHz/85Hz, 1600x1200) H character pattern and crosshatch pattern.

For step (3), use all preset timing H character patterns and crosshatch patterns.

- (1) Display a green or white crosshatch pattern, and adjust the focus according to the procedure mentioned above.
- (2) If the DBF voltage is insufficient or excessive, select HFOCS (DBF-H-AMP) from OSM, and readjust with (-) (+) buttons. Then repeat step (1), and adjust so that the following judgement conditions are satisfied.
- (3) For all of the other preset timings, if the DBF voltage is insufficient or excessive, select HFOCS (DBF-H-AMP) from OSM, and readjust with (-) (+) buttons.
- (4) If the focus is unbalanced at right side and left side with other preset timings. Select HFOCD (DBF-H-PHASE) and readjust with (-) (+) buttons.
- (5) If the focus is unbalanced at top and bottom with timing No. 12 (106.25kHz/85Hz, 1600 x 1200), select DBF2T (DBFV2 TOP) and DBF2B (DBFV2 BOTTOM) and readjust with (-) (+) buttons.

(6) After inputting check timing No. 5 in user mode and operates AUTO-ADJUST function, confirm the focus with "e" character pattern in reverse. If "e" character is indistinct, repeat step (1) to readjust.

\*Adjustment voltage max value:

DBF-H-AMP H width: 396mm: 430V

DBF-V-AMP V width: 297mm: 200V

The focus is judged as follows.

Timing	Judgment pattern (Note 1) (Note 2)
Normal display (All preset)	Crosshatch pattern
Reverse display Resolution: $\leq 1600 \times 1200$ Resolution: $> 1600 \times 1200$	Judge with pattern A Judge with pattern B

(Note 1) Pattern A: Font 7 × 9, Cell 10 × 11, e character  
Pattern B: Font 7 × 9, Cell 10 × 11, H character

(Note 2) Focus judgement: Crosshatch pattern should be used for normal display judgement  
The ratio of core : Halo is as follows.

Should be 1 : 0.5 or less at the center of the picture.

Should be 1 : 1.5 or less at the both sides of the picture

To judge the reverse display, do not carry out a relative evaluation with the other point on the screen. Instead, judge whether the e (H) character can be read distinctly at that point.

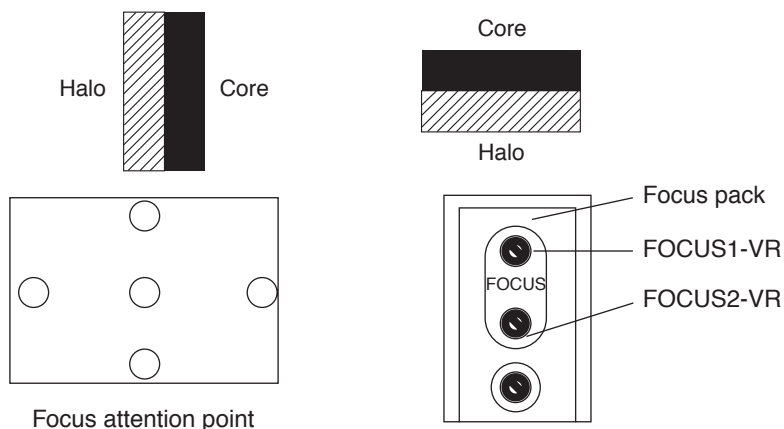

## 2.4.8 Adjusting the convergence

### 2.4.8.1 Adjusting with ITC

Before adjusting the center mis-convergence and axial mis-convergence, carry out sufficient full white aging (100cd/m<sup>2</sup> or more, for one hour or more). Then, adjust with the following timing.

Timing: No. 12 (106.25kHz/85Hz, 1600x1200) crosshatch pattern

Confirm that the following DDCP default setting is as shown in the table of 2.3.2.2 Factory mode (OSM display matrix).

All items of OSM group USER5 and FACT2 of Factory mode

Adjust the horizontal and vertical convergence to the optimum setting with the CRT CP ring, etc.

(Refer to following drawings.)

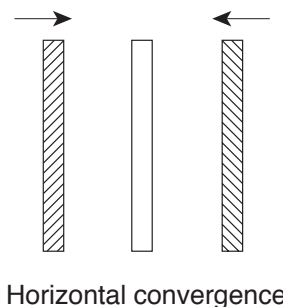
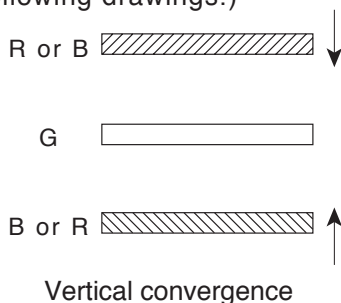

# Adjusting the center misconvergence and axial misconvergence

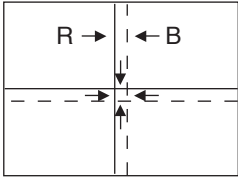
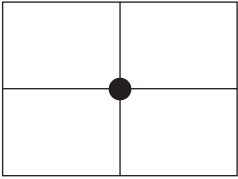
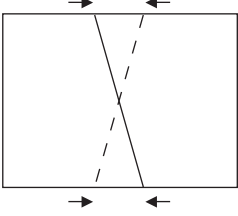
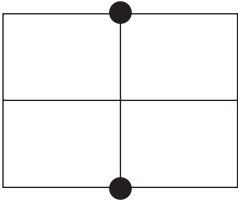
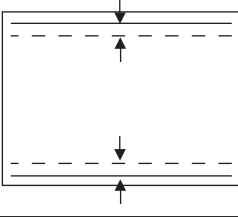
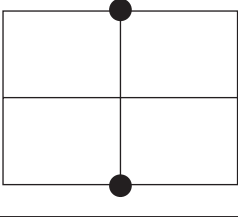
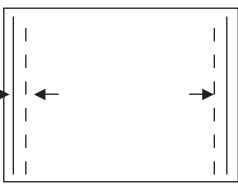
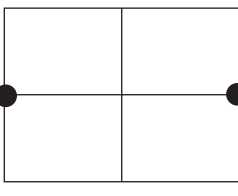
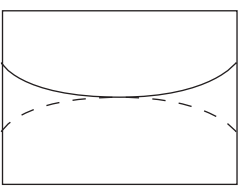
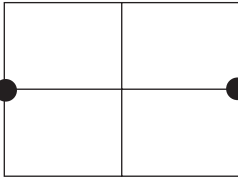
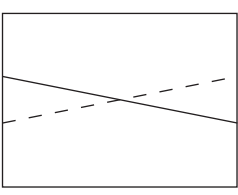
Adjustment item name	Problem	Adjustment point	Adjustment procedure
H-STATIC V-STATIC			Adjust to +/- 0.1mm or less with CP-ASSY 4P.
YH axial deviation			Adjust so that TOP+BOTTOM are +/- 0.1mm or less with YH volume.
YV axial deviation			Adjustment making much of horizontal trapezoidal distortion  Adjust optimally using DY left/right shaking YV volume. The remaining YV misconvergence should be adjusted with DDCP.
XH axial deviation			Adjust so that LEFT-RIGHT is +/- 0.1mm or less with XH slider.
XV characteristics			Only when XV (B-Bow) is +/- 0.15mm or more, adjust so that LEFT-RIGHT is +/- 0.15mm or less with the interlock of B-Bow 4P and CP-ASSY 4P.
XV axial deviation			Adjust so that LEFT+RIGHT is +/- 0.15mm or less with XV differential coil.

B-Bow 4p and CP-ASSY 4p

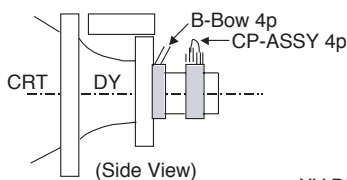

Correction Method

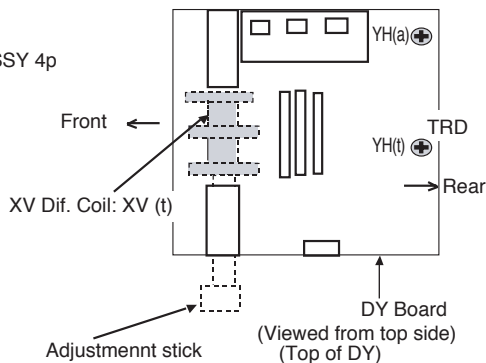



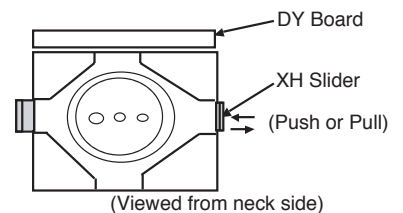





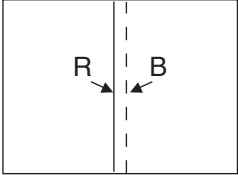
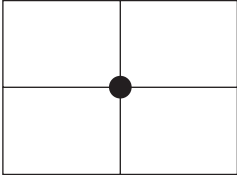
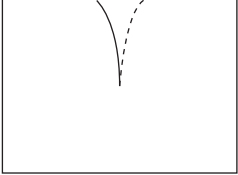
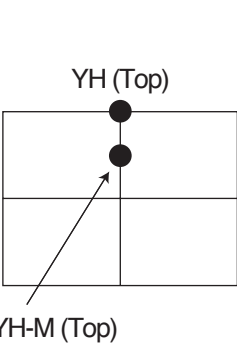
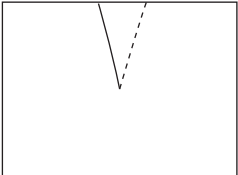
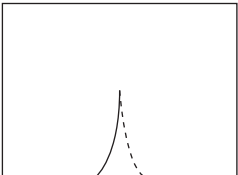
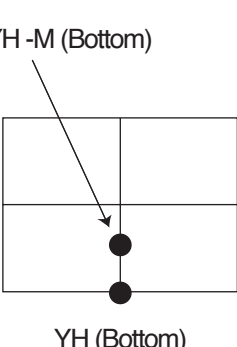
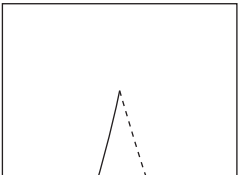

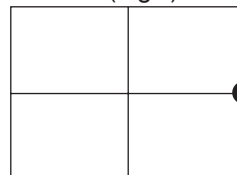

XH Slider

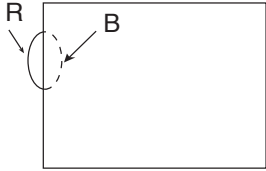
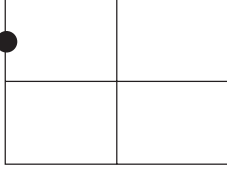

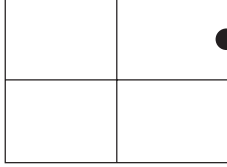

### 2.4.8.2 Adjusting DDCP

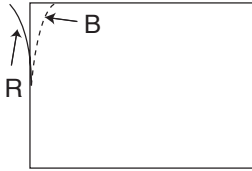
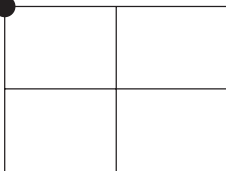
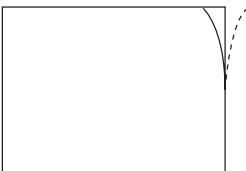
- (1) Input the timing No. 12 (106.25kHz/85Hz,1600x1200) crosshatch pattern.
- (2) Enter the factory mode.
- (3) Adjust in the following order. (It is assumed that the center and axial misconvergence on the previous page have already been adjusted.)

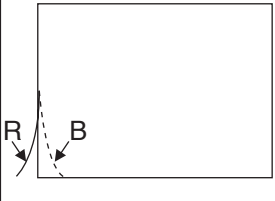
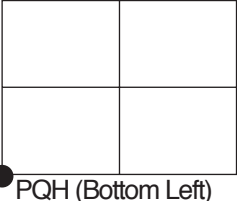
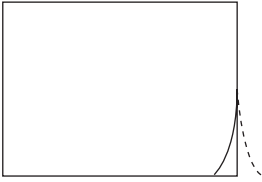

Adjustment order	Adjustment item name	Problem	Adjustment point	Adjustment procedure
<b>4H-COIL</b>				
1	CONVERGENCE HOR.			Adjust to 0.05mm or less. (Adjustment target is 0mm.)
2	YH-TT		 <p>YH (Top)</p> <p>YH-M (Top)</p>	Adjust YH (Top) to 0.05mm or less with balance adjustment of YH-TT and YH-JT. (Adjustment target is 0mm.)  (NOTE) The operating amount at YH-M (Top) when moving YH-TT and YH-JT : YH-TT < YH-JT
	YH-JT			
3	YH-TB		 <p>YH-M (Bottom)</p> <p>YH (Bottom)</p>	Adjust YH (Bottom) to 0.05mm or less with balance adjustment of YH-TB and YH-JB. (Adjustment target is 0mm.)  (NOTE) The operating amount at YH-M (Bottom) when moving YH-TB and YH-JB : YH-TB < YH-JB
	YH-JB			
4	XH-L		 <p>XH(Left)</p>	Adjust to 0.1mm or less.
5	XH-R		 <p>XH(Right)</p>	Adjust to 0.1mm or less.

Adjustment order	Adjustment item name	Problem	Adjustment point	Adjustment procedure
4H-COIL				
6	S3H-TL		S3H(Top Left) 	Adjust to 0.3mm or less.
7	S3H-TR		S3H(Top Right) 	Adjust to 0.3mm or less.
8	S3H-BL		S3H(Bottom Left) 	Adjust to 0.3mm or less.
9	S3H-BR		S3H(Bottom Right) 	Adjust to 0.3mm or less.
10	PQH-TL		PQH (Top Left) 	Adjust to 0.3mm or less.
11	PQH-TR		PQH (Top Right) 	Adjust to 0.3mm or less.

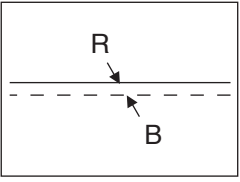
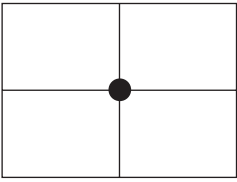
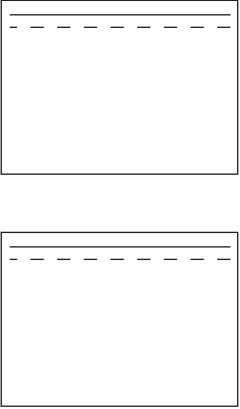
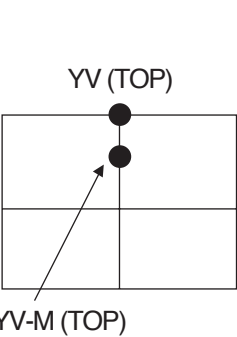
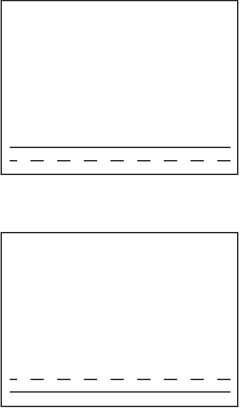
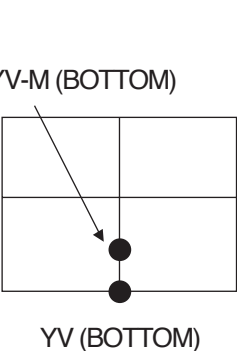
Adjustment order	Adjustment item name	Problem	Adjustment point	Adjustment procedure
<b>4H-COIL</b>				
12	PQH-BL			Adjust to 0.3mm or less.
13	PQH-BR			Adjust to 0.3mm or less.

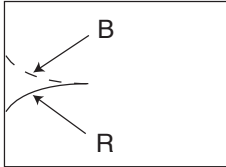
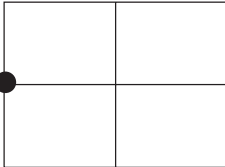
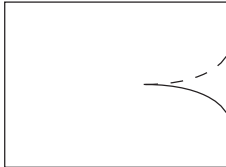
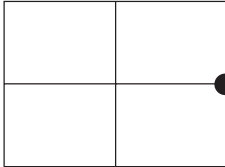
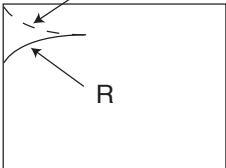
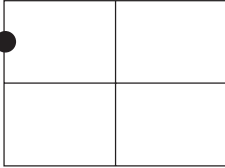
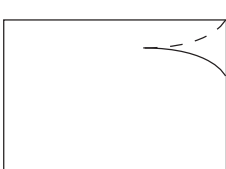
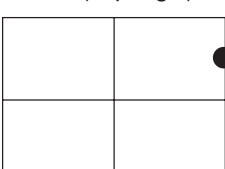
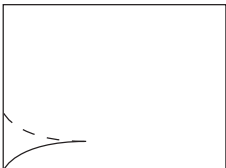
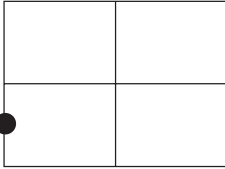
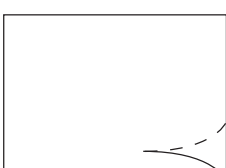
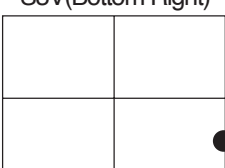
Adjustment order	Adjustment item name	Problem	Adjustment point	Adjustment procedure
<b>4V-COIL</b>				
1	CONVERGENCE VER.			Adjust to 0.05mm or less. (Adjustment target is 0mm.)
2	YV-TT YV-JT			Adjust YV (Top) to 0.05mm or less with balance adjustment of YV-TT and YV-JT. (Adjustment target is 0mm.)  (Note) The operating amount at YV-M (Top) when moving YV-TT and YV-JT. YV-TT < YV-JT
3	YV-TB YV-JB			Adjust YV (Bottom) to 0.05mm or less with balance adjustment of YV-TB and YV-JB. (Adjustment target is 0mm.)  (Note) The operating amount at YV-M (Bottom) when moving YV-TB and YV-JB. YV-TB < YV-JB

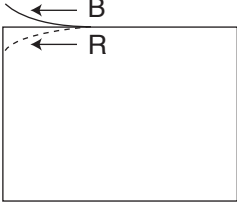
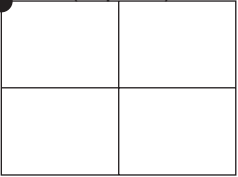
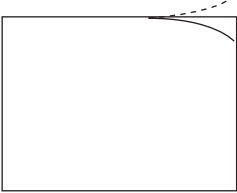
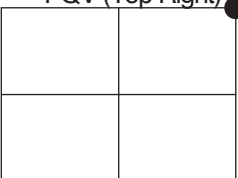
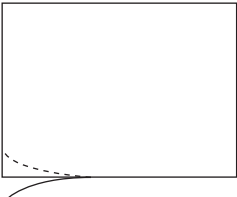
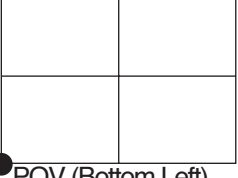
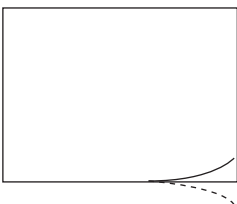
Adjustment order	Adjustment item name	Problem	Adjustment point	Adjustment procedure
4V-COIL				
4	XV-L		XV(Left) 	Adjust to 0.1mm or less.
5	XV-R		XV(Right) 	Adjust to 0.1mm or less.
6	S3V-TL		S3V(Top Left) 	Adjust to 0.3mm or less.
7	S3V-TR		S3V(Top Right) 	Adjust to 0.3mm or less.
8	S3V-BL		S3V(Bottom Left) 	Adjust to 0.3mm or less.
9	S3V-BR		S3V(Bottom Right) 	Adjust to 0.3mm or less.

Adjustment order	Adjustment item name	Problem	Adjustment point	Adjustment procedure
4V-COIL				
10	PQV-TL			Adjust to 0.3mm or less.
11	PQV-TR			Adjust to 0.3mm or less.
12	PQV-BL			Adjust to 0.3mm or less.
13	PQV-BR			Adjust to 0.3mm or less.

\* Specify the adjustment value range of the following adjustment items in general DDCP adjustment.

Adjustment items

- CONVERGENCE (HOR.)
- CONVERGENCE (VER.)
- YHJT
- YHJB

Adjustment value range (Factory mode))

- 2Bh (43) - D3h (211) (OSM display value=DAC output value)
- 2Bh (43) - D3h (211) (OSM display value=DAC output value)
- Dh (13) - F1h (241)
- Dh (13) - F1h (241)



## 2.4.9 Default settings (With factory mode)

Status indicator	Adjustment item	Adjustment mode/set	Input signal/pattern
	Default settings	Factory mode	Each adjustment timing

- (1) Set the default values as shown in the table (user mode) given in OSM display (Refer to 2.3.2.1 User mode).  
If the setting class is an item with each timing, carry out with each adjustment timing.
- (2) Return to the user mode with the front panel.
- (3) Execute FACTORY PRESET to confirm that each OSM setting is as shown in the table (user mode) given in OSM display (Refer to 2.3.2.1 User mode).  
Only CONTRAST will be set to 100% when RESET button is pressed in the normal mode.
- (4) How to set OSM BRIGHTNESS RESET value (30.1%) in user mode.
  - (a) Change to FACTORY MODE in advance.
  - (b) Set the counter of FACT DATA on OSM to 99 using (-) (+) buttons, and push SELECT button.
  - (c) Using ( ◀ ) ( ▶ ) buttons to set ADDR to 0B1.
  - (d) Using (-) (+) buttons set DATA to 04D.
  - (e) Press EXIT button to record 04D set in (d) mentioned above.
  - (f) To disable this rewriting function, turn the power OFF (FACTORY MODE is still alive even if the power was turned OFF).

Return to USER MODE.

Select BRIGHTNESS with OSM, and press RESET button, then the data (04D = 30.1%) set in (d) mentioned above is called.

(For your information; when (-) and (+) buttons are pressed simultaneously, the data is set to 50%.)

- (5) After setting the default values, turn the power button OFF.

## 2.5 Inspections (In normal mode)

Status indicator	Adjustment item	Adjustment mode/set	Input signal/pattern
	Inspections	Normal mode	

### 2.5.1 Electrical performance

Inspect the electrical performance after confirming that the CONTRAST is set to MAX and the BRIGHTNESS is set to center (by pressing (-) (+) buttons simultaneously).

After inspection, carry out FACTORY PRESET operation.

#### 2.5.1.1 Withstand voltage

There must be no abnormality when 1500VAC is applied for two seconds between both ends of the AC input terminal and chassis, and between the DG coil terminal and chassis.

The cut-off current should be 20mA.

#### 2.5.1.2 Grounding conductivity check

Check that the resistance value is 100mΩ or less when 25A is passed between the AC input terminal grounding GND and chassis GND.

#### 2.5.1.3 Degaussing coil operation

Confirm that when OSM DEGAUSS is executed, the picture vibrates and then stops.

#### 2.5.1.4 IPM OFF MODE function operation (Set the AC power input to 230V)

Confirmation timing
Timing No. 12 (106.25kHz / 85Hz, 1600x1200)

Use the full white pattern without R, G, B signals.

Select IPM OFF MODE from OSM, and set to 1:ENABLE.

##### (1) IPM OFF MODE ENABLE

- (a) Confirm that when R, G, B, H/V SYNC signals are removed, the system waits for approx. five seconds, displays IPM OFF MODE for approx. three seconds, and then the picture darkens.

Also confirm that Power Indicator changes to orange and the power consumption is as follows.

Power consumption□	3W or less
--------------------	------------

- (b) Confirm that when R, G, B, H/V SYNC signals are input again, the high voltage is recovered, and the picture appears in approx. five seconds.

## 2.5.1.5 Confirming the GLOBAL SYNC (CORNER-Purity) function

Confirmation timing
Timing No. 12 (106.25kHz / 85Hz, 1600x1200)

Input a (full white display), and press (-)(+) buttons to change GLOBAL SYNC (TR/TL/BR/BL). Confirm that the color coordination around the picture changes.

### 2.5.1.6 Focus, picture performance

Status indicator	Adjustment item	Adjustment mode/set	Input signal/pattern
	Focus, picture performance		Check timing No.5, "e" character reverse display Check timing No.6, chrosshatch normal display

The picture must be evenly bright with check timing No. 5 "e" character reverse display and check timing No. 6 chrosshatch normal display.

### 2.5.1.7 Misconvergence

After heat running for 20 minutes or more, the mis-convergence amount in the horizontal and vertical directions must be below the following values.

The mis-convergence amount is the value between the two colors of R, G and B separated the most in the horizontal (X) and vertical (Y) directions when a 15 vertical lines x 11 horizontal lines crosshatch is displayed.

This adjustment should be carried out with the convergence meter MINOLTA CC-100.





Zone	Mis-convergence amount				
A	0.25mm or less				
B	0.35mm or less				
Measurement timing (Timing No.)	12				



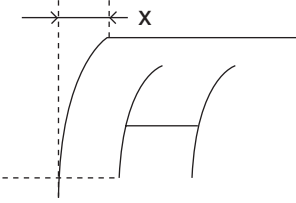
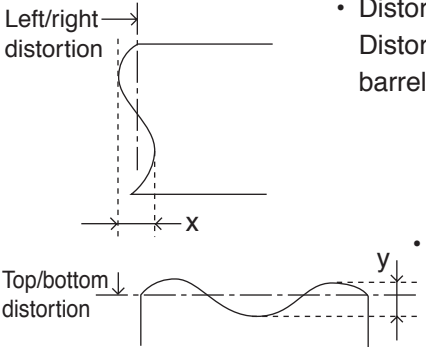

**2.5.1.8 Picture distortion**

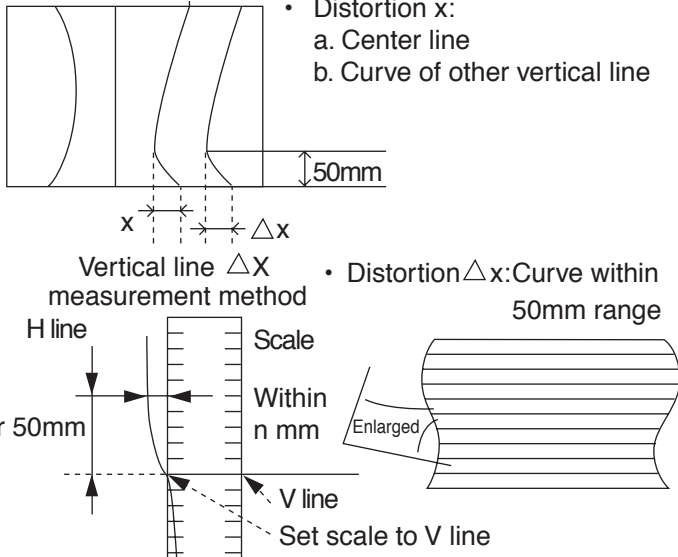
When the picture distortion is measured, each distortion of the preset timing must be less than the following values.

<Picture performance inspection items> Inspect the following items for the picture distortion.

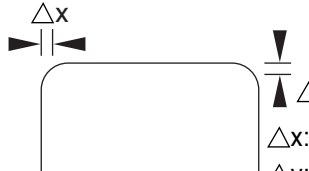
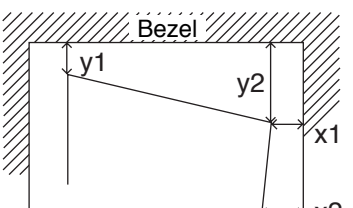
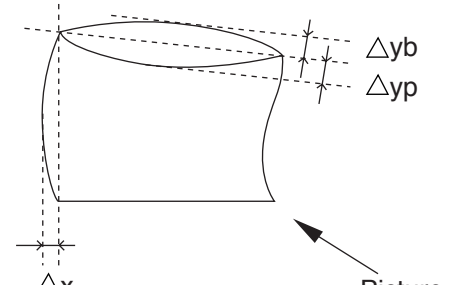
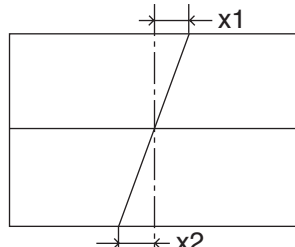
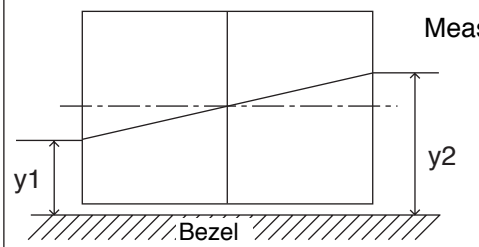
No.	Item	Judgement reference value	Input signal
1.	<p>4-corner section distortion</p> <p>Inspect the distortion at the four corners.</p> <ul style="list-style-type: none"> <li>Signal, H character with frame (both normal/reverse)</li> <li>Distortion x: Distortion in the range of one H character height. Judge with the white display G. (Judge the distortion amount with a fluorescent material stripe.)</li> </ul> 	<p><math>x \leq 1\text{pitch}</math> (=0.3mm)</p>	<p>H character with frame (both normal/reverse)</p>
2.	<p>4-edge distortion</p> <p>When S-character or seagull type high frequency distortion is visible, check with the following method.</p> <ul style="list-style-type: none"> <li>Distortion x of S-character, etc.: Distortion excluding normal pin, barrel or trapezoid.</li> <li>Distortion y: High frequency distortion excluding trapezoid.</li> </ul> 	<p><math>x \leq 0.9\text{mm}</math></p> <p><math>y \leq 1.0\text{mm}</math></p>	<p>Crosshatch pattern</p> 
3.	<p>Inner distortion</p> <ul style="list-style-type: none"> <li>Distortion x: a. Center line b. Curve of other vertical line</li> <li>Distortion <math>\Delta x</math>: Curve within measurement method 50mm range</li> </ul> 	<p>a. <math>x \leq 1.0\text{mm}</math> b. <math>x \leq 1.5\text{mm}</math> (*)</p> <p>(*) Preset No.1 (31.5kHz, 60Hz) is: a. <math>x \leq 1.5\text{mm}</math> b. <math>x \leq 2.0\text{mm}</math></p> <p><math>\Delta x \leq 0.9\text{mm}</math></p>	

No.	Item	Judgement reference value	Input signal
4.	<p>Line curve (crosshatch pattern outer contour)</p>  <p> <math>\Delta x</math>: Curve within 50mm range (horizontal) □  <math>\Delta y</math>: Curve within 50mm range (vertical)         </p>	$\Delta x \leq 1.0\text{mm}$ □ $\Delta y \leq 1.0\text{mm}$	Crosshatch □ pattern
5.	<p>Horizontal trapezoid (top/bottom), vertical trapezoid (left/right)</p>  <ul style="list-style-type: none"> <li>• □ <math>\Delta y =  y1 - y2 </math> □</li> <li>□ <math>\Delta x =  x1 - x2 </math> □</li> <li>• □ Control with the above right value for each the top, bottom, left and right.</li> </ul>	$\Delta y \leq 2.0\text{mm}$ □ $\Delta x \leq 1.8\text{mm}$	
6.	<p>Top/bottom pin and barrel, left/right pin and barrel</p>  <p>Picture</p>	$\Delta y_b \leq 1.3\text{mm}$ □ $\Delta y_p \leq 1.5\text{mm}$ □ $\Delta x \leq 1.3\text{mm}$	
7.	<p>Parallelogram distortion</p>  <p>Measure the larger of <math>x1</math> and <math>x2</math>.</p>	$x \leq 0.8\text{mm}$	
8.	<p>Inclination</p>  <p>Measure <math>\Delta y =  y1 - y2 </math>.</p> <p>Bezel</p>	$\Delta y \leq 2.0\text{mm}$	

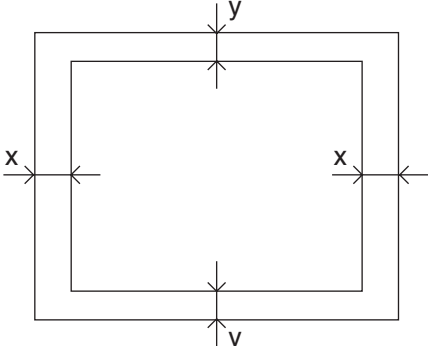
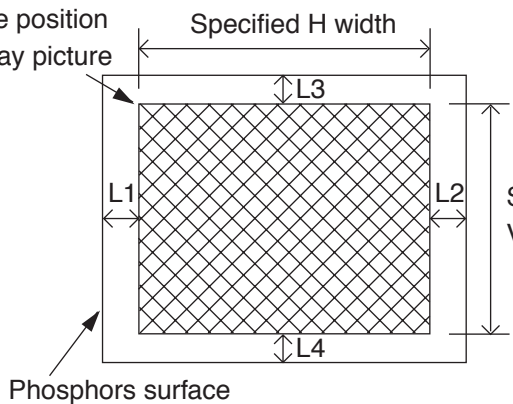
No.	Item	Judgement reference value	Input signal
9.	Distortion Must be within the following frame.* (Note, excluding ROTATION) 	$y \leq 2.0\text{mm}$ $x \leq 2.0\text{mm}$	Crosshatch pattern
10.	Picture position Display picture 	$ L1-L2  \leq 5.0\text{mm}$ $ L3-L4  \leq 3.0\text{mm}$	Full white

### 2.5.1.9 Linearity

Measure the linearity with a 17 horizontal line x 13 vertical line crosshatch.

Horizontal linearity : fH=30-40kHz whole : 15% or less, adjacent : 7% or less

fH=40-60kHz whole : 12% or less, adjacent : 7% or less

fH=60-140kHz whole : 10% or less, adjacent : 7% or less

Vertical linearity : whole : 10% or less, adjacent : 7% or less

Calculation expression :  $\frac{(X_{\max} - X_{\min})}{(X_{\max} + X_{\min})/2} \times 100(\%)$

\* If any doubts arise about the judgment, judge with the horizontal/vertical width tolerance of  $\pm 3\text{mm}$ , picture position:  $|L1-L2|=3\pm 1\text{mm}$  and  $|L3-L4| \leq 3.0\text{mm}$ .

### 2.5.1.10 Adjustment value list

The horizontal width, vertical width and DBF-H/V amplitude must be within the following ranges.

Timing No.	Horizontal width (mm) Adj. value	Vertical width (mm) Adj. value	DBF-H amplitude (H)		DBF-V amplitude (V)	
			Standard Adj. value	Max. Adj. value	Standard Adj. value	Max. Adj. value
1						
2	396 ± 5	297 ± 4	400 ± 5	430	135 ± 20	200
3						
4						
5	396 ± 5	297 ± 4	400 ± 5	430	135 ± 20	200
6						
7	396 ± 5	297 ± 4	400 ± 5	430	135 ± 20	200
8	396 ± 5	297 ± 4	400 ± 5	430	135 ± 20	200
9	396 ± 5	297 ± 4	400 ± 5	430	135 ± 20	200
10	396 ± 5	297 ± 4	400 ± 5	430	135 ± 20	200
11	396 ± 5	297 ± 4	400 ± 5	430	135 ± 20	200
12	396 ± 5	297 ± 4	400 ± 5	430	135 ± 20	200
13						
14						
15	396 ± 5	297 ± 4	400 ± 5	430	135 ± 20	200
16						
17						
18						
19						
20						
21						
22						
23						
24						
25	396 ± 5	297 ± 4	400 ± 5	430	135 ± 20	200
26						
27						
28						

Standard adjustment value: in case of determining DBF voltage

Maximum adjustment value: the value impossible to set the maximum of DBF voltage

### 2.5.1.11 Confirming EDGELOCK and SYNC ON GREEN

Confirm that the following criterion is satisfied when timing No. Check 1 (35kHz/66Hz) with full white.  
<Criterion>

The back raster color coordination should vary when the setting is changed to BACK from FRONT.

### 2.5.1.12 Checking the functions during Composite Sync input

Status indicator	Adjustment item	Adjustment mode/set	Input signal/pattern
	Checking the functions during Composite Sync input		Check 2 : 35kHz / 66Hz
			Full white

[Composite Sync]

Timing: Check 2 (35kHz/66Hz), full white

In the normal mode, input the above timing to confirm that the operation is normal.

### 2.5.1.13 Confirming the reset operation

Confirmation timing
Timing No. 12 (106.25kHz / 85Hz, 1600x1200)

In the normal mode, after varying NARROW/WIDE somewhat, press RESET button to confirm that the data returns to the original value.

### 2.5.1.14 Confirming the full white luminance/color coordination

Status indicator	Adjustment item	Adjustment mode/set	Input signal/pattern
	Confirming the full white luminance / color coordination	Factory mode	No.12: 106.25kHz / 85Hz, 1600x1200
			Full white

Input timing No. 12 (106.25kHz/85Hz, 1600x1200), and confirm that the full white luminance/color coordination is the following value.

\*9300K: should be confirmed with COLOR 1.

\*5000K: should be confirmed with COLOR 5.

\*6500K: should be confirmed using color temperature 6500K with color temperature adjustment (☉☉☉).

Confirm that the signal is input to INPUT 2.

Confirmed item		9300K	6500K	5000K
Luminance		105 or more	90 or more	77 or more
Color temperature	x	$0.283 \pm 0.007$	$0.313 \pm 0.007$	$0.345 \pm 0.007$
	y	$0.297 \pm 0.007$	$0.329 \pm 0.007$	$0.359 \pm 0.007$

Confirmation of OSM color temperature (9300K)

$x=0.283 \pm 0.04$        $Y=0.297 \pm 0.05$

\* Confirmation should be carried out at white section on OSM picture.

Note) In case confirmation is carried out with INPUT 1, the tolerance of color coordination should be " $\pm 0.009$ ".

### 2.5.1.15 Confirming CONVERGENCE compensation function

Confirm that CONVERGENCE changes by varying CONVERGENCE (HOR.) and CONVERGENCE (VER.).



### 2.5.1.16 Confirming ROTATION compensation function

Confirm that the picture rotates by changing ROTATE.

### 2.5.1.17 Luminance/color coordination uniformity

Status indicator	Adjustment item	Adjustment mode/set	Input signal/pattern
	Luminance/color coordination uniformity		No.12: 106.25kHz / 85Hz, 1600x1200

The luminance ratio between the center and periphery must be 80% or more with timing No. 12 (106.25kHz/85Hz, 1600x1200) COLOR 1.

The color coordination difference between the center and periphery must be  $\Delta x, y < \pm 0.012$  with COLOR 1.

### 2.5.1.18 Confirming the color tracking

Status indicator	Adjustment item	Adjustment mode/set	Input signal/pattern
	Confirming color tracking	Factory mode	No.12 : 106.25kHz/85Hz, 1600x1200
			BRIGHTNESS : 7F (50%)

Confirm with the timing No. 12 (106.25kHz/85Hz, 1600x1200), BRIGHTNESS : 7F (50%) and COLOR1 (9300K) in factory mode.

Measure the color coordination at the center of the picture using a full white pattern (input amplitude = 0.7Vp-p).

Confirm that the color coordination change is within the  $\pm 0.015$  range when the CONTRAST is set to 25cd/m<sup>2</sup> with OSM.

### 2.5.1.19 CRT installation position

CRT installation position tolerance    Within  $\pm 3$ mm in vertical direction    Within  $\pm 2.5$ mm in horizontal direction  
Inclination: Within  $\pm 2.5$ mm at bezel reference

### 2.5.1.20 Confirming SB MODE operation

Timing No.12 (106.25kHz/85Hz, 1600x1200) white window

Input amplitude = 0.7Vp-p

The following items should be confirmed with CONTRAST: MAX and BRIGHTNESS: 50%.

SB MODE	Confirmation item	9300K	
SB-MODE2	W-Window luminance	150 or more	
	W-Window color coordination	x	$0.283 \pm 0.015$
		y	$0.297 \pm 0.015$
	Back raster luminance	Approx. 0.8cd/m <sup>2</sup>	

\* Confirm that the color is not saturated with the white window picture during SB MODE2 operating.

\* Confirm the following items during SB MODE2 operating.

(1) Compensation of  $\gamma$ :

Confirm that A and B of the following test pattern become similar black color.

Confirm that C and D of the following test pattern become similar white color.

(2) Compensation of outline:

Confirm that the overshoot (ringing) appears on the left edge of C of the following test pattern.

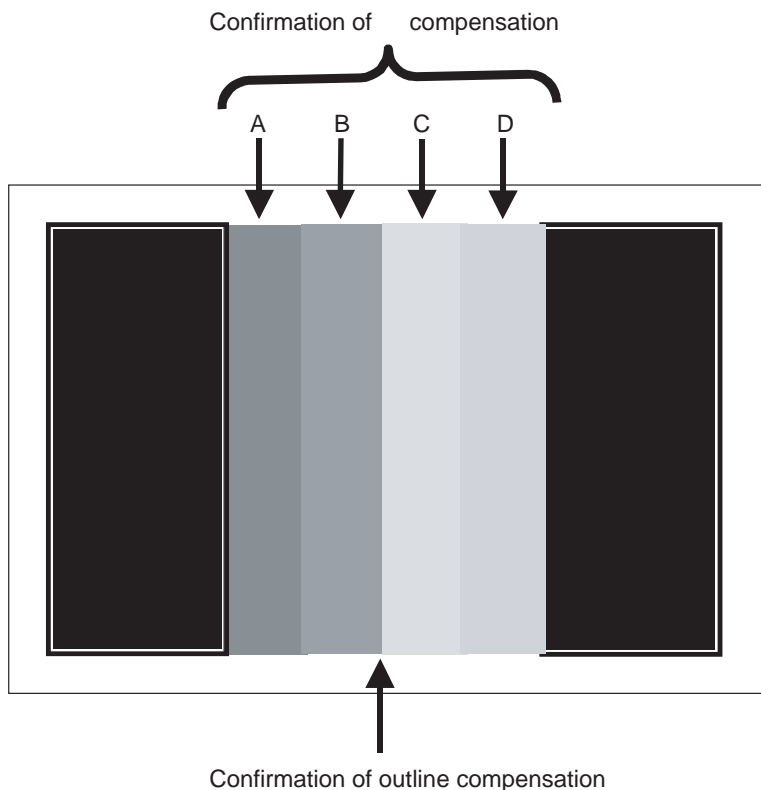

### 2.5.1.21 Confirming AUTO-ADJUST operation

(Timing No. 29 (137kHz/85Hz, 2048X1536))

- (1) Select AUTO ADJUST with OSM in user mode, and press (+) button.
- (2) Confirm that AUTO ADJUST function operates and the crosshatch frame should be within phosphor area.

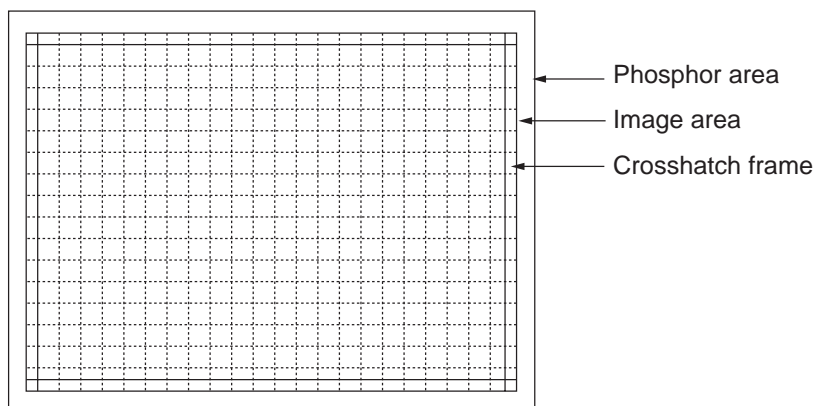

### 2.5.1.22 Confirming USB

Confirming USB hub

- (1) Connect upstream connector to PC with USB cable.
- (2) Connect USB device to downstream connector 1, and confirm the operation.
- (3) Connect USB device to downstream connector 2, and confirm the operation.
- (4) Connect USB device to downstream connector 3, and confirm the operation.
- (5) Connect USB device to downstream connector 4, and confirm the operation.
- (6) Disconnect USB cable.

### 2.5.1.23 Others

- (1) When any button is pressed, the changes must be smooth, and there must be no abnormalities such as noise.
- (2) Synchronization must not flow when the power button is turned ON and OFF.
- (3) Confirm that Power Indicator is lit.

## 2.6 DDC function, check of asset management

This writing operation should be carried out with the service tool (refer to the followings for detail of service tool).

The version of the service tool software used is as follows.

Service tool S/W folder name: SVT312NM211

Service tool S/W version: Ver3.12-2.1-1

Be sure to read "Read me first" first in using the service tool.

For concrete use, refer to the service tool manual attached to the service tool.

Lower 5 digits of S/N	converted to hex. Numbers	registered in ascending order		
Upper 3 digits of S/N	0 (according to VESA standard)	Models having NO ASSET function	Models having ASSET function	
		MPU side Address (H)	Dedicated EEPROM side Address (H)	Data (H)
(Ex.) 512002978	00000BA2	78C	0C	A2
		78D	0D	0B
		78E	0E	00
		78F	0F	00

[ASCII conversion]

Using the barcode system read the serial numbers (9 digits) assigned at NMV (Nagasaki), then establish the serial number through the following conversion.

S/N converted to ASCII code registered (to Monitor Descriptor #4) in descending order

(ex.) 512A02978

35 31 32 41 30 32 39 37 38

Models having NO ASSET function	Models having ASSET function		
MPU side Address (H)	Dedicated EEPROM side Address (H)	Data (H)	
E81	71	35	
E82	72	31	
E83	73	32	
E84	74	41	
E85	75	30	
E86	76	32	
E87	77	39	
E88	78	37	
E89	79	38	
E8A	7A	0A	shows the end of S/N data*
E8B	7B	20	shows blank*
E8C	7C	20	shows blank*
E8D	7D	20	shows blank*

\*Fixed data (set according to the number of digits of S/N)

## 2.6.1 DDC write data contents

The contents of DDC write data must be as follows.

```
EDID DATA DUMP HEX
00 FF FF FF FF FF FF 00
34 AC 32 46 SN SN SN SN
WW YY 01 03 0E 28 1E 78
EB 9C 68 A0 57 4A 9B 26
12 48 4C FF EF 80 31 59
45 59 61 59 71 4F 81 99
A9 4F D1 59 E1 59 A6 59
40 30 62 B0 32 40 40 C0
13 00 8C 29 11 00 00 1E
00 00 00 FD 00 32 A0 1E
8C 2A 00 0A 20 20 20 20
20 20 00 00 00 FC 00 44
50 72 6F 20 32 30 37 30
53 42 0A 20 00 00 00 FF
00 S2 S2 S2 S2 S2 S2 S2
S2 S2 S2 S2 S2 S2 00 CS
```

SN: Serial number  
WW: Week of Manufacture  
YY: Year of Manufacture  
S2: ASCII Serial Number  
CS: Check Sum

-- EDID DATA DUMP TEXT --  
Manufacturer Code: MEL  
Product Code (HEX): 4632  
Product Code (DEC): 17970  
(Microsoft INF ID: MEL4632)  
Serial Number (HEX): SN  
Week of Manuf: WW  
Year of Manuf: YY

EDID Version: 1  
EDID Revision: 3  
Extension Flag: 0

Video:  
Input Singal: ANALOG  
Setup: NO  
Sync on Green: YES  
Composite Sync: YES  
Separate Sync: YES  
V Sync Serration: NO  
V Signal Level:  
0.700V/0.300V (1V p-p)

Max Image Size H: 40 cm  
Max Image Size V: 30 cm  
DPMS Stand By: YES  
DPMS Suspend: YES  
DPMS Active Off: YES  
GTF Support: YES  
Standard Default Color Space: NO  
Preferred Timing Mode: YES  
Display Type: RGB Color

Color:  
Gamma: 2.20  
Red x: 0.627  
Red y: 0.341  
Green x: 0.292  
Green y: 0.605  
Blue x: 0.149  
Blue y: 0.072  
White x: 0.283  
White y: 0.297

Established Timings:  
720x400 @ 70 Hz  
720x400 @ 88 Hz  
640x480 @ 60 Hz  
640x480 @ 67 Hz  
640x480 @ 72 Hz  
640x480 @ 75 Hz  
800x600 @ 56 Hz  
800x600 @ 60 Hz  
800x600 @ 72 Hz  
800x600 @ 75 Hz  
832x624 @ 75 Hz  
1024x768 @ 60 Hz  
1024x768 @ 70 Hz  
1024x768 @ 75 Hz  
1152x870 @ 75 Hz  
1280x1024 @ 75 Hz

Standard Timing #1:  
Horizontal Active Pixels: 640  
Aspect Ratio: 4:3  
(480 active lines)  
Refresh Rate: 85 Hz

Standard Timing #2:  
Horizontal Active Pixels: 800  
Aspect Ratio: 4:3  
(600 active lines)  
Refresh Rate: 85 Hz

Standard Timing #3:  
Horizontal Active Pixels: 1024  
Aspect Ratio: 4:3  
(768 active lines)  
Refresh Rate: 85 Hz

Standard Timing #4:  
Horizontal Active Pixels: 1152  
Aspect Ratio: 4:3  
(864 active lines)  
Refresh Rate: 75 Hz

Standard Timing #5:  
Horizontal Active Pixels: 1280  
Aspect Ratio: 5:4  
(1024 active lines)  
Refresh Rate: 85 Hz

Standard Timing #6:  
Horizontal Active Pixels: 1600  
Aspect Ratio: 4:3  
(1200 active lines)  
Refresh Rate: 75 Hz

Standard Timing #7:  
Horizontal Active Pixels: 1920  
Aspect Ratio: 4:3  
(1440 active lines)  
Refresh Rate: 85 Hz

Standard Timing #8:  
Horizontal Active Pixels: 2048  
Aspect Ratio: 4:3  
(1536 active lines)  
Refresh Rate: 85 Hz

Detailed Timing (block #1):  
---Preferred Timing Mode---  
Pixel Clock: 229.50 MHz  
Horizontal Active: 1600 pixels  
Horizontal Blanking: 560 pixels  
Vertical Active: 1200 lines  
Vertical Blanking: 50 lines  
(Horizontal Frequency: 106.25 kHz)  
(Vertical Frequency: 85.0 Hz)  
Horizontal Sync Offset: 64 pixels  
Horizontal Sync Width: 192 pixels  
Vertical Sync Offset: 1 lines  
Vertical Sync Width: 3 lines  
Horizontal Border: 0 pixels  
Vertical Border: 0 lines  
Horizontal Image Size: 396 mm  
Vertical Image Size: 297 mm  
Interlaced: NO  
Image: Normal Display  
Sync: Digital Separate  
Bit 1: ON  
Bit 2: ON

Monitor Range Limits (block #2):  
Minimum Vertical Rate: 50 Hz  
Maximum Vertical Rate: 160 Hz  
Minimum Horizontal Rate: 30 kHz  
Maximum Horizontal Rate: 140 kHz  
Maximum Pixel Clock: 420 MHz  
GTF Data: 00 0a 20 20 20 20 20 20

Monitor Name (block #3):  
DPro 2070SB

Monitor Serial Number (block #4): S2

SN: Serial number  
WW: Week of Manufacture  
YY: Year of Manufacture  
S2: ASCII Serial Number

EDID EDITOR V1.45 (010514) Copyright  
(C) Mitsubishi Electric 1995-2000

## 2.6.2 Self-diagnosis shipment setting

The shipment settings for self-diagnosis data area (region) are given below.

ADR	Shipment Setting (H)	LABEL NAME
0x08C to 0x08F	0x00	Heater operating time
0x0B6 to 0x0B9	0x00	Operating time
0x0C0	0x00	High voltage error rate
0x0C1	0x00	High voltage suspension rate
0x0C2	0x00	Short circuit rate
0x0C3	0x00	High voltage data error rate
0x0C4	0x00	Deflection suspension rate
0x0C5	0x00	Heater error rate
0x0C6	0x00	ABL error

## 2.7 Default inspection

### 2.7.1 Default setting of switches

Confirm that the following switch is set as follows.

- (1) Power switch: OFF

### 2.7.2 Default setting of OSM

Confirm that each OSM setting is as shown in OSM display (section 2.3.3) table (user mode/factory mode).

If the setting class is an item for each timing, carry out for each adjustment timing.

- \* Only CONTRAST will be set to MAX (100%) when RESET button is pressed in the normal mode.

### 2.7.3 Checking the labels

Confirm that the "SERVICEMAN WARNING", "rating label", "manufacturing date stamp", "SERIAL NO. label", etc., are attached to the specified position, and have been checked.

### 2.7.4 Packaging

- (1) There must be no remarkable contamination, tearing or scratches, etc.
- (2) The model name must be accurately displayed.
- (3) The SERIAL NO. must be attached. (Must be the same No. as the set.)
- (4) The package must be accurately sealed.

## 2.8 Degaussing with handy-demagnetizer

### 2.8.1 General precautions

- (1) Carry this procedure out with the monitor power ON.
- (2) When degaussing with handy-demagnetizer, the demagnetizer power must be turned ON and OFF at a position at least 1m away from CRT tube.
- (3) Use a bar type demagnetizer instead of a ring type.  
Carefully and slowly (1m/3 sec.) demagnetize the CRT tube and bezel side surface.  
When separating the degaussing coil at the end, separate as slow as possible with the following procedure.  
If separated quickly, stripes could remain at the picture corners.

### 2.8.2 How to hold and use the handy-demagnetizer

- (1) Approach the demagnetizer as carefully and slowly (approx. 1m/3 sec.) as possible, and move around the bezel side periphery two to three times.
- (2) Next, gradually (approx. 1m/3 sec.) move to the CRT tube side, and move around the CRT tube four to five times with the following procedure.
- (3) Finally, leave the CRT tube as slowly (approx. 1m/3 sec.) as possible, and turn the handy-demagnetizer unit switch OFF at a position 1 to 1.5m away.

(NOTE): The monitor should be degaussed as whichever following conditions.

- (1) Degauss by handy demagnetizer in off condition.
- (2) Degauss by handy demagnetizer in power management condition.
- (3) Degauss by handy demagnetizer with monitor set degauss operation.

Looking from side of set

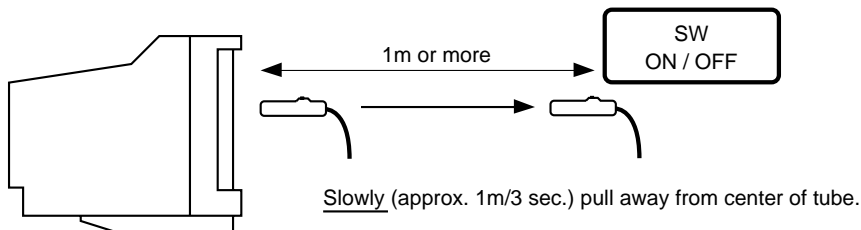

<Holding the handy - demagnetizer>

Face the handy - demagnetizer so that the longitudinal direction is vertical in respect to the CRT.

Do not hold the handy - demagnetizer so that the longitudinal direction is parallel in respect to the CRT.

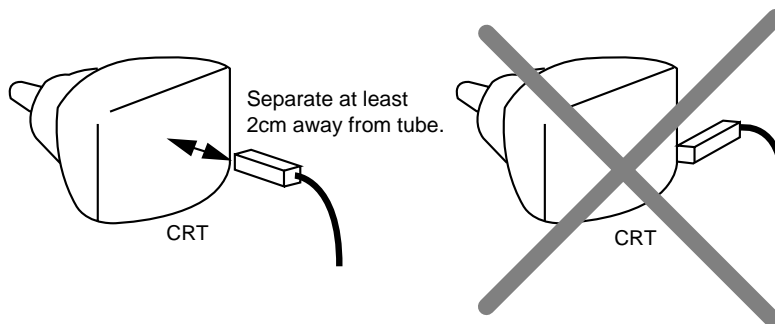

## 2.9 Caution

Do not input the user timing before factory adjustments.

(The automatic tracking of the FOCUS could be adversely affected.)

## 2.10 Timing chart

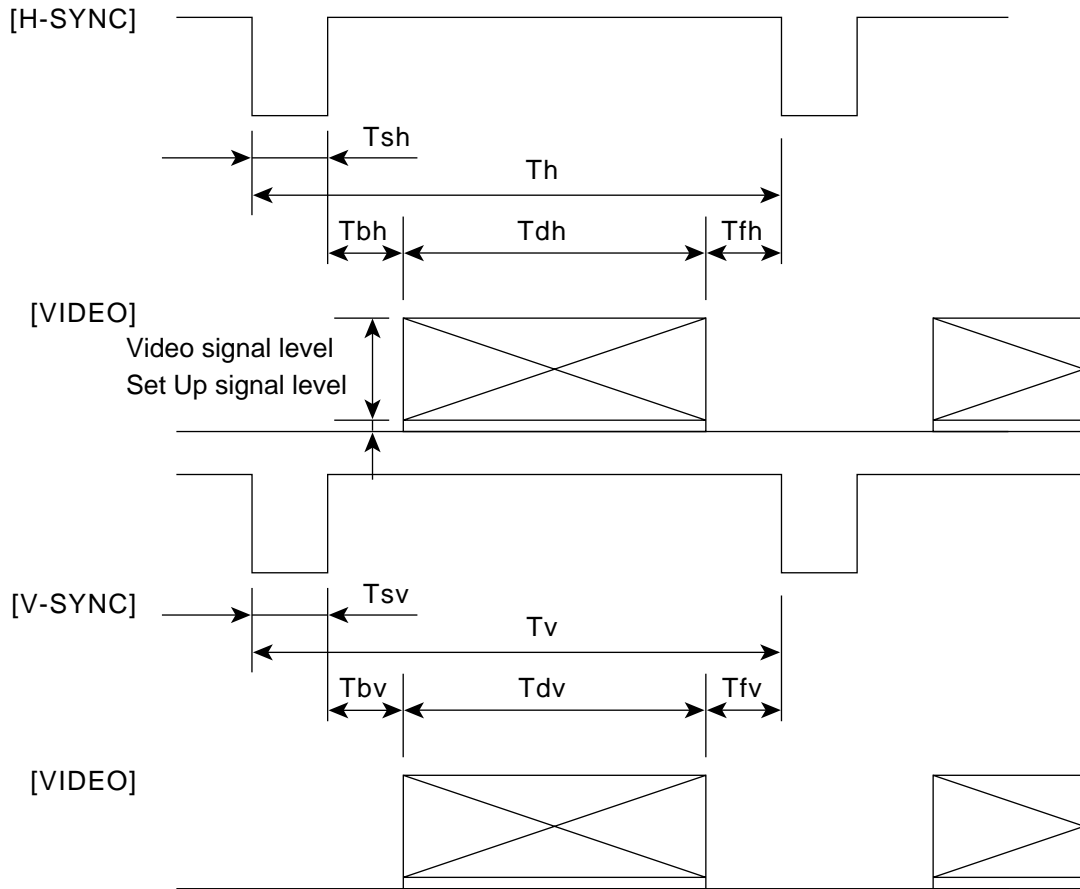

Refer to after the next page for the preset timing details.





NO	Fh	Clock	Th ( $\mu$ SEC)	Tsh ( $\mu$ SEC)	Tfh ( $\mu$ SEC)	Tbh ( $\mu$ SEC)	Tdh ( $\mu$ SEC)	Utili- zation	H re- trace s+f+b	Fv (Hz)	Tv (mSEC)	Tsv (line)	Tfv (mSEC)	Tbv (mSEC)	Tdv (mSEC)	V re- trace	Hs	Vs	VIDEO level (V)	set up level (V)	Serra- tion			Remarks
	(kHz)	(MHz)	(dot)	(dot)	(dot)	(dot)	(dot)				(line)	(line)	(line)	(line)										
1	31.470	28.322	31.777 (800)	3.813 (96)	0.635 (16)	1.907 (48)	25.422 (640)	80.00	6.356	70.090	14.268 (449)	0.064 (2)	0.381 (12)	1.112 (35)	12.711 (400)	1.557	-	+	0.7	-	-			ODS(720*400)70Hz
2	31.469	25.175	31.778 (800)	3.813 (96)	0.636 (16)	1.907 (48)	25.422 (640)	80.00	6.356	59.940	16.683 (525)	0.064 (2)	0.318 (10)	1.048 (33)	15.253 (480)	1.112	-	-	0.7	-	-	1		VGA(640*480)60Hz
3	37.500	31.500	26.667 (840)	2.032 (64)	0.508 (16)	3.810 (120)	20.317 (640)	76.19	6.350	75.000	13.333 (500)	0.080 (3)	0.027 (1)	0.427 (16)	12.800 (480)	0.506	-	-	0.7	-	-			VESA(640*480)75Hz
4	43.269	36.000	23.111 (832)	1.556 (56)	1.556 (56)	2.222 (80)	17.778 (640)	76.92	5.334	85.008	11.764 (509)	0.069 (3)	0.023 (1)	0.579 (25)	11.093 (480)	0.647	-	-	0.7	-	-			VESA(640*480)85Hz
5	46.875	49.500	21.333 (1056)	1.616 (80)	0.323 (16)	3.232 (160)	16.162 (800)	75.76	5.171	75.000	13.333 (625)	0.064 (3)	0.021 (1)	0.448 (21)	12.800 (600)	0.512	+	+	0.7	-	-	2		VESA(800*600)75Hz
6	53.674	56.250	18.631 (1048)	1.138 (64)	0.569 (32)	2.702 (152)	14.222 (800)	76.34	4.409	85.061	11.756 (631)	0.056 (3)	0.019 (1)	0.503 (27)	11.179 (600)	0.559	+	+	0.7	-	-			VESA(800*600)85Hz
7	60.023	78.750	16.660 (1312)	1.219 (96)	0.203 (16)	2.235 (176)	13.003 (1024)	78.05	3.657	75.029	13.328 (800)	0.050 (3)	0.017 (1)	0.466 (28)	12.795 (768)	0.516	+	+	0.7	-	-	3		VESA(1024*768)75Hz
8	68.677	94.500	14.561 (1376)	1.016 (96)	0.508 (48)	2.201 (208)	10.836 (1024)	74.42	3.725	84.997	11.765 (808)	0.044 (3)	0.015 (1)	0.524 (36)	11.183 (768)	0.568	+	+	0.7	-	-	4		VESA(1024*768)85Hz
9	79.976	135.000	12.504 (1688)	1.067 (144)	0.119 (16)	1.837 (248)	9.481 (1280)	75.82	3.023	75.025	13.329 (1066)	0.038 (3)	0.013 (1)	0.475 (38)	12.804 (1024)	0.513	+	+	0.7	-	-	5		VESA(1280*1024)75Hz
10	91.146	157.500	10.971 (1728)	1.016 (160)	0.406 (64)	1.422 (224)	8.127 (1280)	74.08	2.844	85.027	11.761 (1072)	0.033 (3)	0.011 (1)	0.483 (44)	11.235 (1024)	0.516	+	+	0.7	-	-	6		VESA(1280*1024)85Hz
11	93.750	202.500	10.667 (2160)	0.948 (192)	0.316 (64)	1.501 (304)	7.901 (1600)	74.07	2.765	75.000	13.333 (1250)	0.032 (3)	0.011 (1)	0.491 (46)	12.800 (1200)	0.523	+	+	0.7	-	-	7		VESA(1600*1200)75Hz
12	106.250	229.500	9.412 (2160)	0.837 (192)	0.279 (64)	1.325 (304)	6.972 (1600)	74.08	2.441	85.000	11.765 (1250)	0.028 (3)	0.009 (1)	0.433 (46)	11.294 (1200)	0.461	+	+	0.7	-	-	8		VESA(1600*1200)85Hz
13	106.270	261.00	9.41 (2456)	0.828 (216)	0.368 (96)	1.349 (352)	6.866 (1792)	72.96	2.545	74.997	13.334 (1417)	0.028 (3)	0.009 (1)	0.649 (69)	12.647 (1344)	0.677	-	+	0.7	-	-			VESA(1792*1344)75Hz
14	112.500	288.000	8.889 (2560)	0.778 (224)	0.444 (128)	1.222 (352)	6.444 (1856)	72.49	2.444	75.000	13.333 (1500)	0.027 (3)	0.009 (1)	0.924 (104)	12.373 (1392)	0.951	-	+	0.7	-	-			VESA(1856*1392)75Hz
15	112.500	297.000	8.889 (1640)	0.754 (224)	0.485 (144)	1.185 (352)	6.4654 (1920)	72.73	2.424	75.000	13.333 (1500)	0.027 (3)	0.009 (1)	0.498 (56)	12.800 (1440)	0.525	-	+	0.7	-	-	9		VESA(1920*1440)75Hz
16	35.00	30.240	28.571 (864)	2.116 (64)	2.116 (64)	3.175 (96)	21.164 (640)	74.08	7.407	66.67	15.000 (525)	0.086 (3)	0.086 (3)	1.114 (39)	13.714 (480)	1.2	-	-	0.7	-	-			APPLE13(640*480)
17	49.710	57.270	20.115 (1152)	1.118 (64)	0.559 (32)	3.910 (224)	14.528 (832)	72.22	5.587	74.530	13.417 (667)	0.060 (3)	0.020 (1)	0.785 (39)	12.552 (624)	0.845	-	-	0.7	-	-			APPLE16(832*624)
18	60.240	80.000	16.600 (1328)	1.200 (96)	0.400 (32)	2.200 (176)	12.800 (1024)	77.11	3.800	74.930	13.346 (804)	0.050 (3)	0.049 (3)	0.498 (30)	12.749 (768)	0.548	-	-	0.7	-	-			APPLE19(1024*768)
19	68.680	100.000	14.560 (1456)	1.280 (128)	0.320 (32)	1.440 (144)	11.520 (1152)	79.12	3.040	75.060	13.322 (915)	0.044 (3)	0.043 (3)	0.568 (39)	12.667 (870)	0.612	-	-	0.7	-	-			APPLE21(1152*870)
20	100.200	219.638	9.980 (2192)	0.801 (176)	0.546 (120)	1.348 (296)	7.285 (1600)	73.00	2.695	75.000	13.333 (1336)	0.03 (3)	0.01 (1)	0.519 (52)	12.774 (1280)	0.549	-	-	0.7	-	-			GTF(1600*1280)75Hz
21	107.200	234.982	9.328 (2192)	0.749 (176)	0.511 (120)	1.260 (296)	6.809 (1600)	73.00	2.520	80.000	12.5 (1340)	0.028 (3)	0.009 (1)	0.522 (56)	11.94 (1280)	0.55	-	-	0.7	-	-			GTF(1600*1280)80Hz
22	114.240	252.242	8.754 (2208)	0.698 (176)	0.507 (128)	1.205 (304)	6.343 (1600)	72.46	2.410	85.000	11.765 (1344)	0.026 (3)	0.009 (1)	0.525 (60)	11.204 (1280)	0.551	-	-	0.7	-	-			GTF(1600*1280)85Hz
23	105.675	261.229	9.463 (2472)	0.766 (200)	0.521 (136)	1.286 (336)	6.891 (1800)	72.82	2.573	75.000	13.333 (1409)	0.028 (3)	0.009 (1)	0.52 (55)	12.775 (1350)	0.548	-	-	0.7	-	-			GTF(1800*1350)75Hz
24	113.040	279.435	8.846 (2472)	0.716 (200)	0.487 (136)	1.202 (336)	6.442 (1800)	72.82	2.405	80.000	12.5 (1413)	0.027 (3)	0.009 (1)	0.522 (59)	11.943 (1350)	0.549	-	-	0.7	-	-			GTF(1800*1350)80Hz
25	120.455	299.667	8.303 (2488)	0.667 (200)	0.481 (144)	1.148 (344)	6.007 (1800)	72.35	2.296	85.000	11.765 (1417)	0.025 (3)	0.008 (1)	0.523 (63)	11.208 (1350)	0.548	-	-	0.7	-	-	10		GTF(1800*1350)85Hz
26	112.725	278.656	8.871 (2472)	0.718 (200)	0.488 (136)	1.206 (336)	6.460 (1800)	72.82	2.412	75.000	13.333 (1503)	0.027 (3)	0.009 (1)	0.523 (63)	12.774 (1440)	0.55	-	-	0.7	-	-			GTF(1800*1440)75Hz
27	120.560	299.953	8.295 (2488)	0.667 (200)	0.480 (144)	1.147 (344)	6.001 (1800)	72.34	2.294	80.000	2.5 (1507)	0.025 (3)	0.008 (1)	0.523 (63)	11.944 (1440)	0.548	-	-	0.7	-	-			GTF(1800*1440)80Hz
28	80.530	105.656	12.418 (1312)	1.060 (112)	0.303 (32)	1.363 (144)	9.692 (1024)	78.05	2.726	100.000	10.0 (805)	0.037 (3)	0.012 (1)	0.410 (33)	9.537 (768)	0.463	-	-	0.7	-	-			ELSA(1024*768)100Hz
29	137.020	388.041	7.298 (2832)	0.577 (224)	0.433 (168)	1.010 (392)	5.278 (2048)	72.18	2.020	85.000	11.765 (1612)	0.022 (3)	0.007 (1)	0.525 (72)	11.210 (1536)	0.555	-	-	0.7	-	-			GTF(2048*1536)85Hz

Mark ○: Factory adjustment. The number after the mark is the preset number.

Mark □: Factory adjustment [Though they are presets, it does not apply to the specification of the picture distortion. The sync. signals are reference to the above. (It is possible to reset with the above timings.)]

Mark ▲: Initial data [So long as initial data, the sync. signals are reference to Hs: + and Vs: -. However, it is necessary to adjust only the NARROW/WIDE, LEFT/RIGHT, DBF-H-AMP and DBF-H-PHASE in factory mode.

The numbers after the marks are the number of preset.

### 3. TROUBLESHOOTING

This chapter for troubleshooting is useful if any normal conditions cannot be secured even after the confirmation of “Troubleshooting” presented in the User’s Manual and the completion of “Chapter 3. Adjustment procedures” presented in this Service Manual.

The equipment units related to the possible cause of “Picture bounces or a wavy patterns is present in the picture” described in “Troubleshooting” presented in the User’s Manual include the electrical equipment such as portable telephones, etc., which may generate electromagnetic waves. Therefore, troubleshooting actions should be taken after turning off the portable telephones, etc., and such electrical equipment that may generate electromagnetic waves, or in a place distant from such equipment.

#### Contents

	Page
3.1 No Raster Generated .....	3-2
3.2 Abnormal Picture .....	3-4
3.2.1 Raster Brightness Failure .....	3-4
3.2.2 Image Color Failure or Contrast Failure .....	3-4
3.2.3 Sync Failure .....	3-5
3.2.3.1 Horizontal Sync Unstable .....	3-5
3.2.3.2 Vertical Sync Unstable .....	3-6
3.2.4 Screen Size and Screen Position Failure .....	3-7
3.2.4.1 Horizontal Size Failure .....	3-7
3.2.4.2 Horizontal Position Failure .....	3-8
3.2.4.3 Vertical Size and Position Failure .....	3-8
3.2.5 Linearity Failure .....	3-9
3.2.5.1 Horizontal Linearity Failure .....	3-9
3.2.5.2 Vertical Linearity Failure .....	3-10
3.2.6 Distortion Compensation Circuit Failure .....	3-11
3.2.6.1 IN/OUT (pincushion), ALIGN (trapezoidal) and TOP/BOTTOM (corner correction) Failure ---	3-11
3.2.6.2 LEFT/RIGHT (pincushion balance), TILT (parallelogram), and TOP BALANCE/BOTTOM BALANCE (corner correction) Failure .....	3-11
3.2.6.3 ROTATE (raster rotation) Failure .....	3-11
3.2.7 Focus Failure .....	3-12
3.3 Functional Errors .....	3-14
3.3.1 OSM Failure .....	3-14
3.3.2 Power Management Functional Operation Error .....	3-15
3.3.3 Plug & Play (DDC2B) Operation Error .....	3-16
3.3.4 Degaussing Functional Operation Error .....	3-16
3.3.5 Earth Magnetism Canceling Functional Operation Error .....	3-17
3.3.6 Key Operation Error .....	3-17
3.4 Circuit Errors .....	3-18
3.4.1 Power Circuit Failure .....	3-18
3.4.2 Horizontal Oscillation / Deflection Circuit Failure .....	3-19
3.4.3 Vertical Oscillation / Deflection Circuit Failure .....	3-20
3.4.4 HV Circuit Failure .....	3-21
3.4.5 Video Circuit Failure .....	3-22
3.4.6 Static Convergence Compensation Circuit Failure .....	3-24
3.4.7 Corner Purity Compensation Circuit Failure .....	3-25
3.4.8 MPU Operation Error .....	3-26
3.4.9 Self-Diagnostic Functions .....	3-27
3.4.10 USB Circuit Failure .....	3-28

### 3.1 No Raster Generated

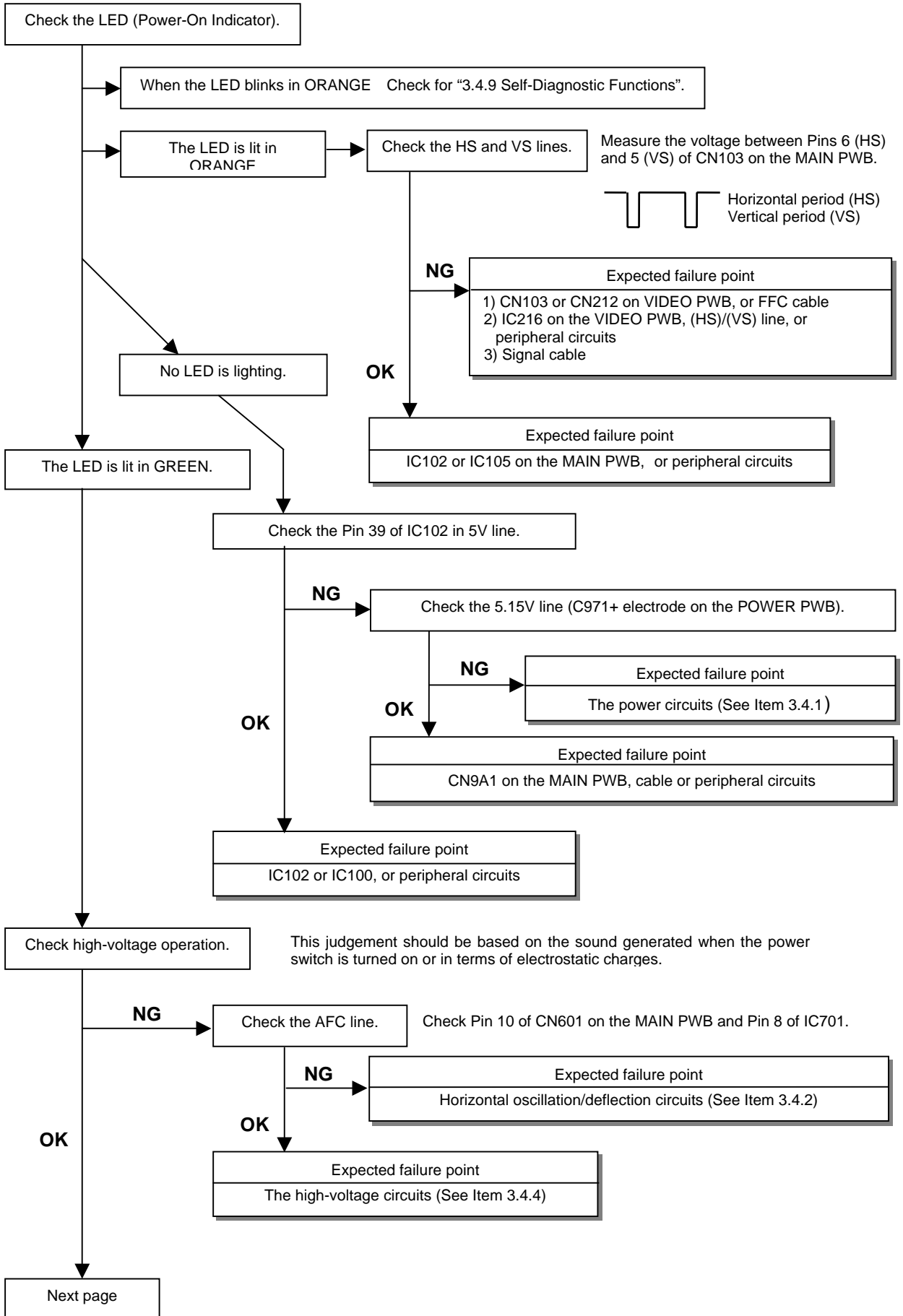

CONTINUE

OK

Is the high voltage maintained at approx. 27kV?

NG

Expected failure point  
1) IC701, Q701 or peripheral circuit  
2) T701 (FBT), C726, R720 or peripheral circuit

OK

Check the R/G/B video output.

Measure the R/G/B video output at Pins R, G and B of CRT socket.

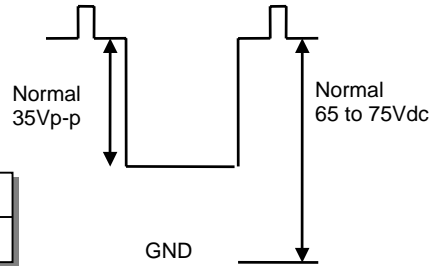

NG

Expected failure point  
Video circuit is (See Item 3.4.5)

OK

Check the heater voltage.

Measure the (heater) voltage at Pin 7 of CN202 on the CRT PWB.

NG

Expected failure point  
CN202, CRT socket, CRT or peripheral circuit

OK

Check the screen voltage.

Measure the voltage of CN201 on the CRT PWB. Usually, the screen voltage is 600 to 800.

NG

Expected failure point  
T701 (FBT), CRT socket or screen lead

OK

Expected failure point  
CRT socket or CRT

## 3.2 Abnormal Picture

### 3.2.1 Raster Brightness Failure

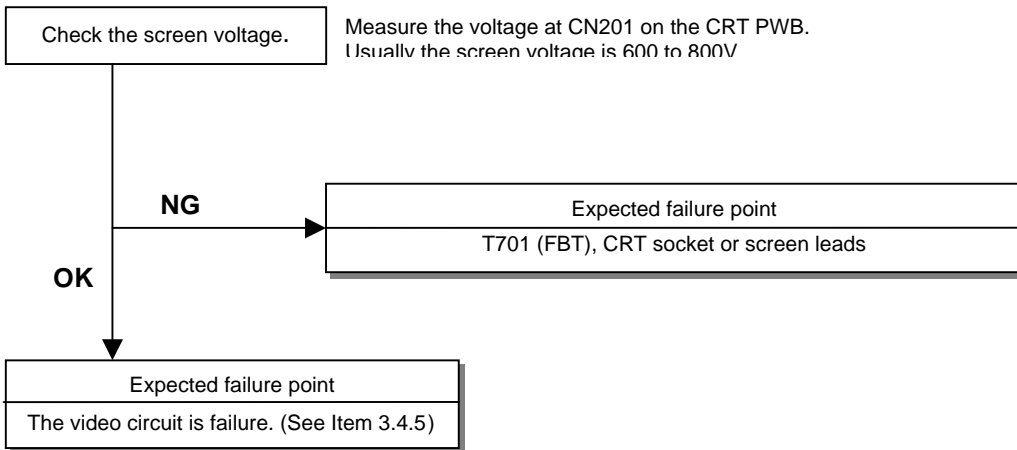

### 3.2.2. Image Color Failure or Contrast Failure

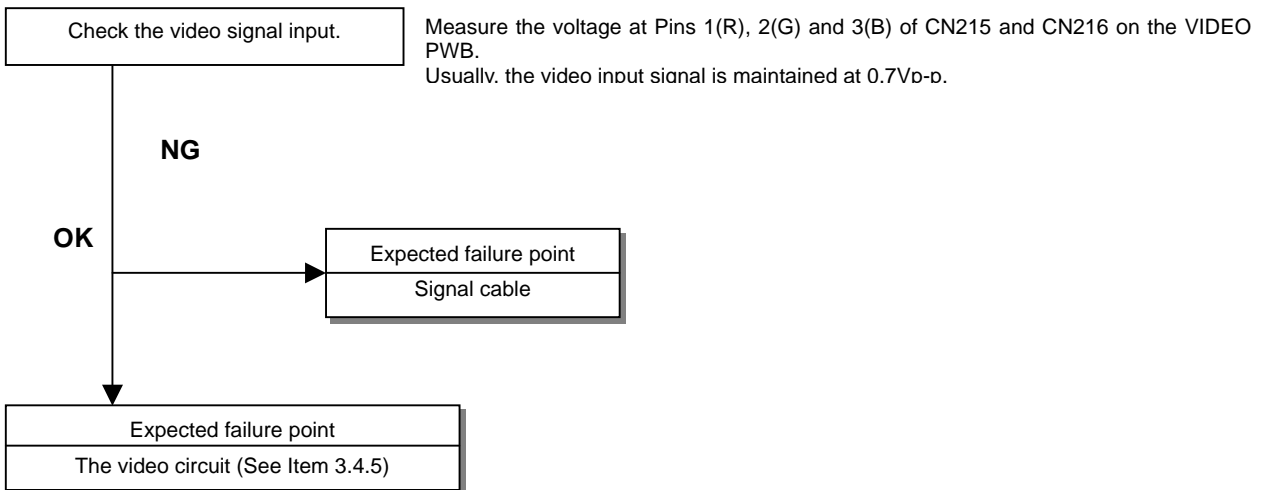

### 3.2.3 Sync Failure

#### 3.2.3.1 Horizontal Sync Unstable

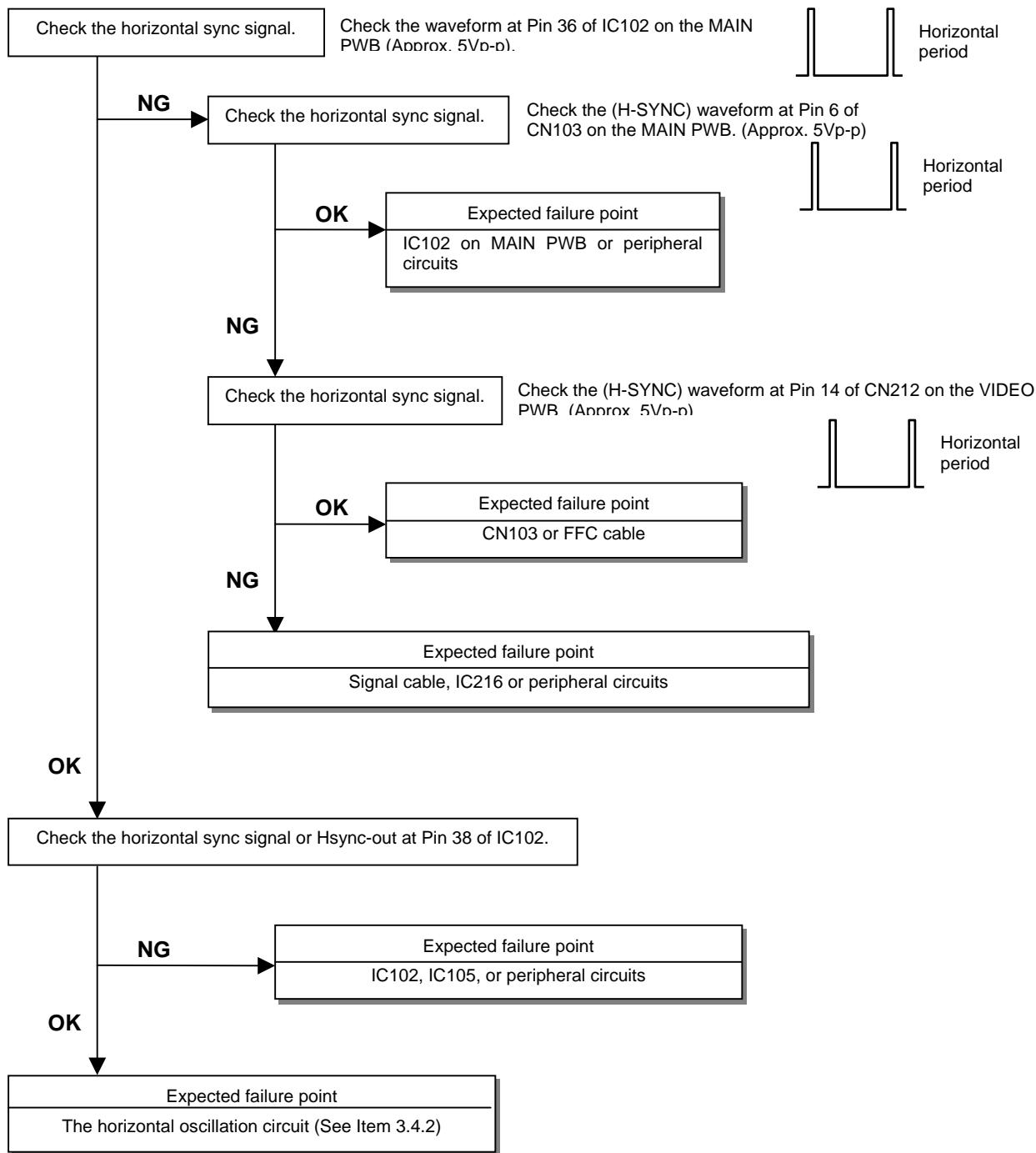

### 3.2.3.2 Vertical Sync Unstable

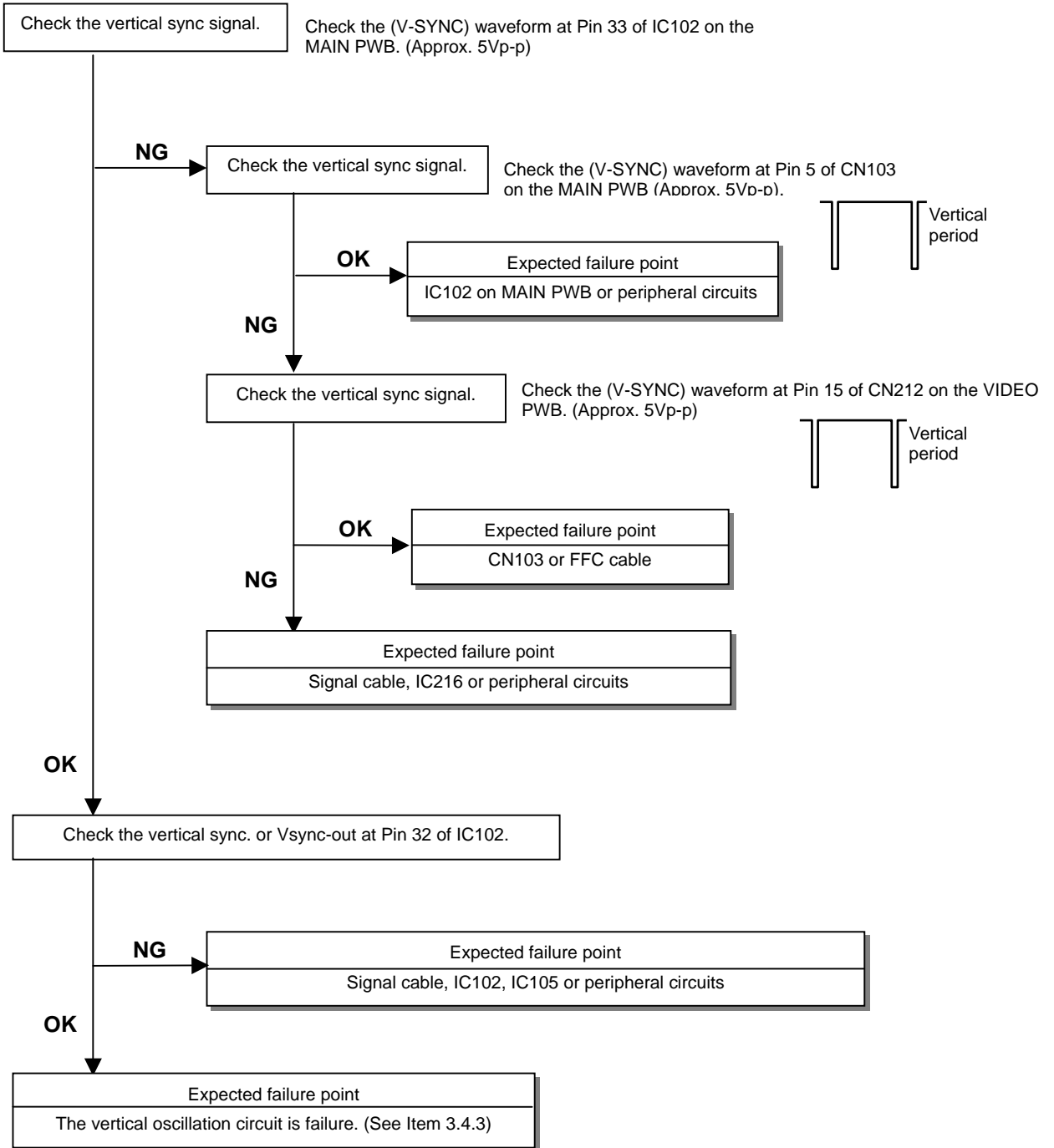

### 3.2.4 Screen Size and Screen Position Failure

#### 3.2.4.1 Horizontal Size Failure

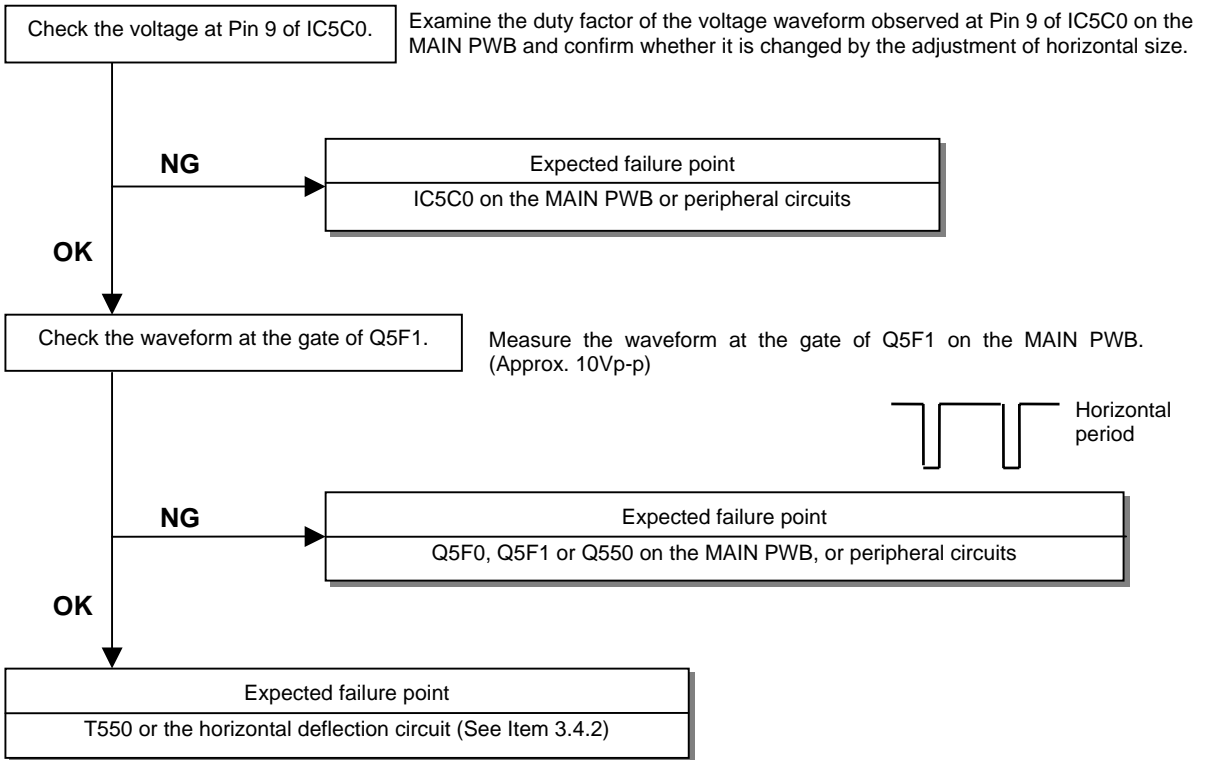



### 3.2.4.2 Horizontal Position Failure

(1) Video

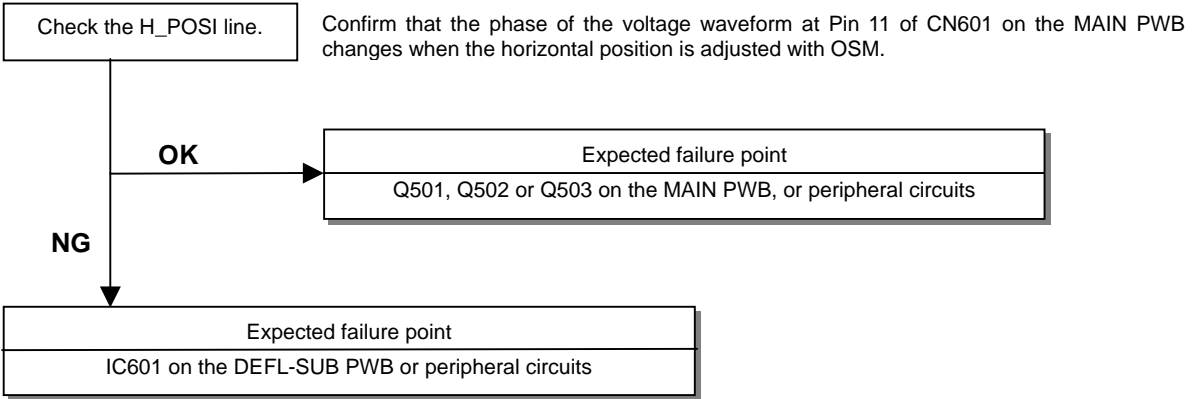

(2) Horizontal raster centering (VR5A1) failure

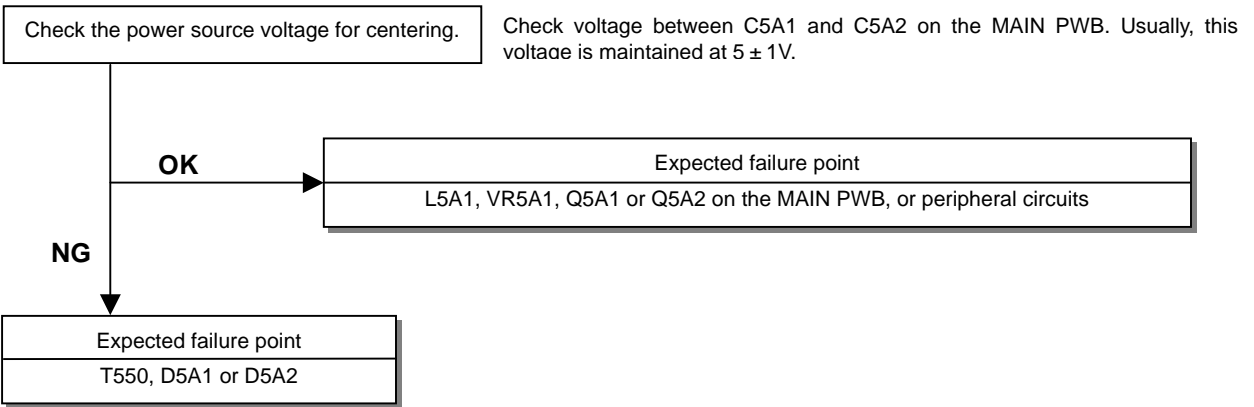

### 3.2.4.3 Vertical Size and Position Failure

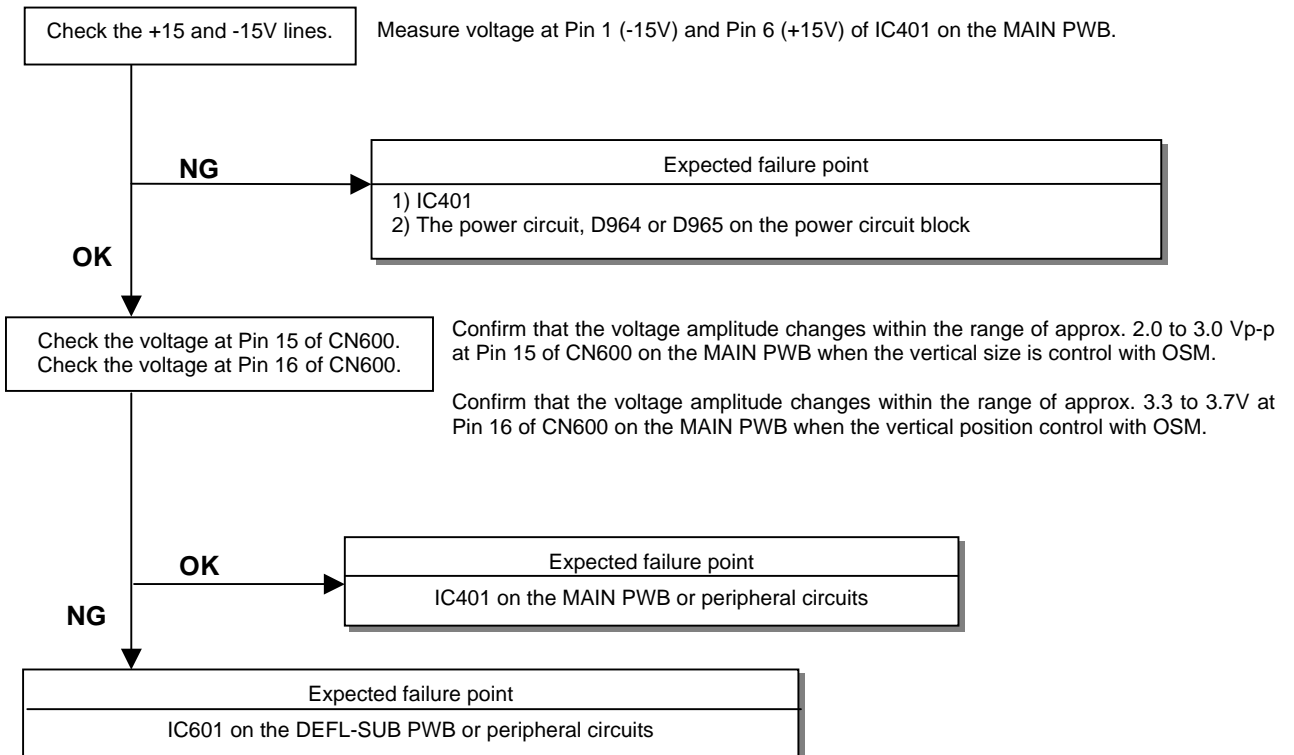

### 3.2.5 Linearity Failure

#### 3.2.5.1 Horizontal Linearity Failure

Check the horizontal frequency band selector.

Check voltage at Pins 57-64 of IC102 on the MAIN PWB.

Preset No.	Fh [kHz]	CS8 64pin Q562	CS7 63pin Q561	CS6 62pin Q566	CS5 61pin Q565	CS4 60pin Q568	CS3 59pin Q567	CS2 58pin Q563	CS1 57pin Q564
1	31.5	H	L	L	L	L	L	L	L
2	46	L	L	L	H	L	H	L	H
3	60	L	H	L	L	H	L	H	H
4	69	H	L	H	L	L	H	H	H
5	80	L	L	H	H	L	H	H	H
6	91	H	L	H	L	H	H	H	H
7	93	L	H	H	L	H	H	H	H
8	106	H	L	L	H	H	H	H	H
9	112	L	L	H	H	H	H	H	H
10	120	H	L	H	H	H	H	H	H

CS switching FET Q561 to Q568 are H: Off, L: ON

**NG**

Expected failure point

IC102 on the MAIN PWB or peripheral circuits

**OK**

Expected failure point

- 1) Relation of Character S capacitor changeover  
Q561- Q568, C564- C568, C576-C578 or C580 on the MAIN PWB, or peripheral circuits
- 2) Relation of linearity coil control  
Q560, L561, IC101 or peripheral circuits

### 3.2.5.2 Vertical Linearity Failure

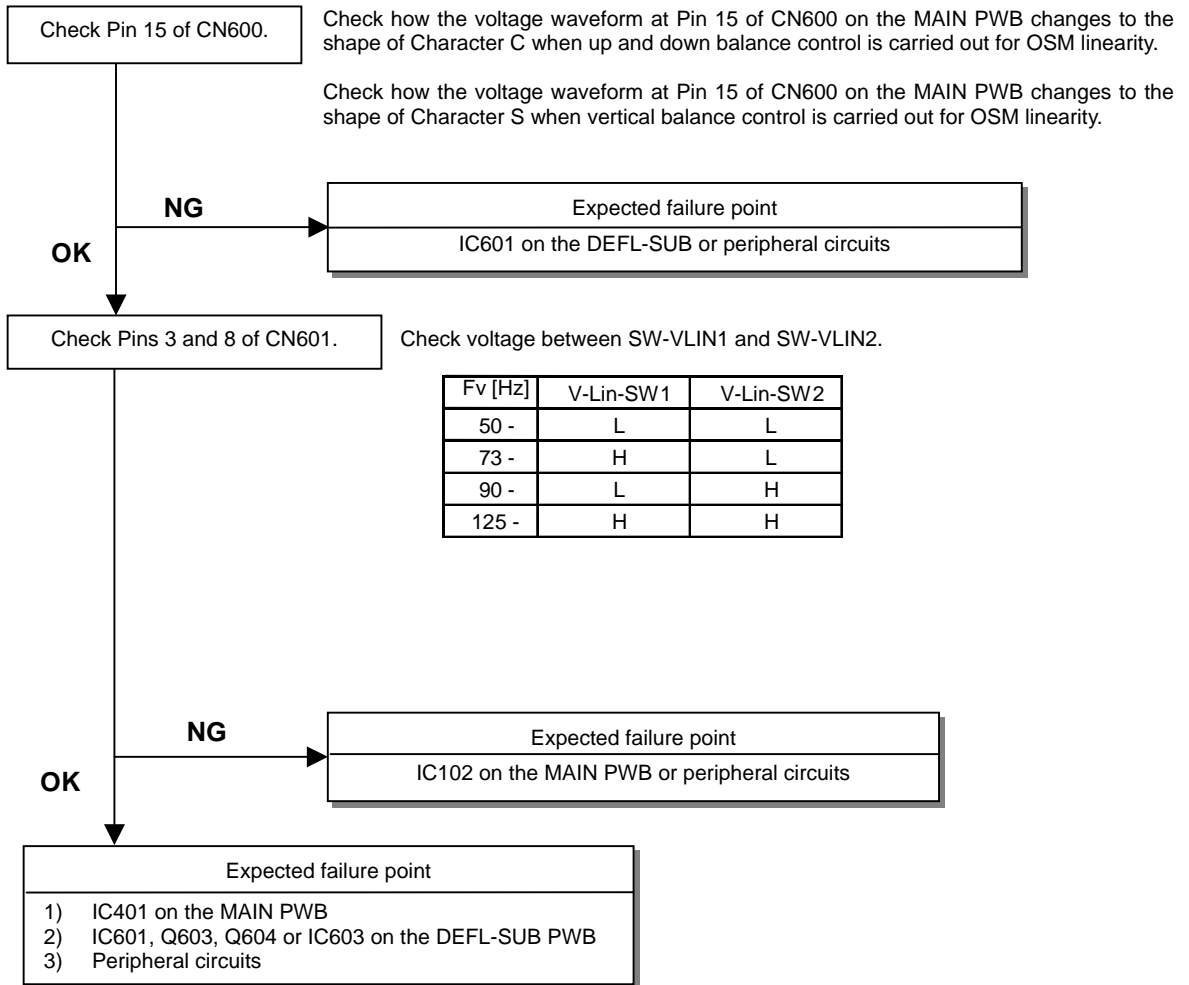

### 3.2.6 Distortion Compensation Circuit Failure

#### 3.2.6.1 IN/OUT (pincushion), ALIGN (trapezoidal) and TOP/BOTTOM (corner correction) Failure

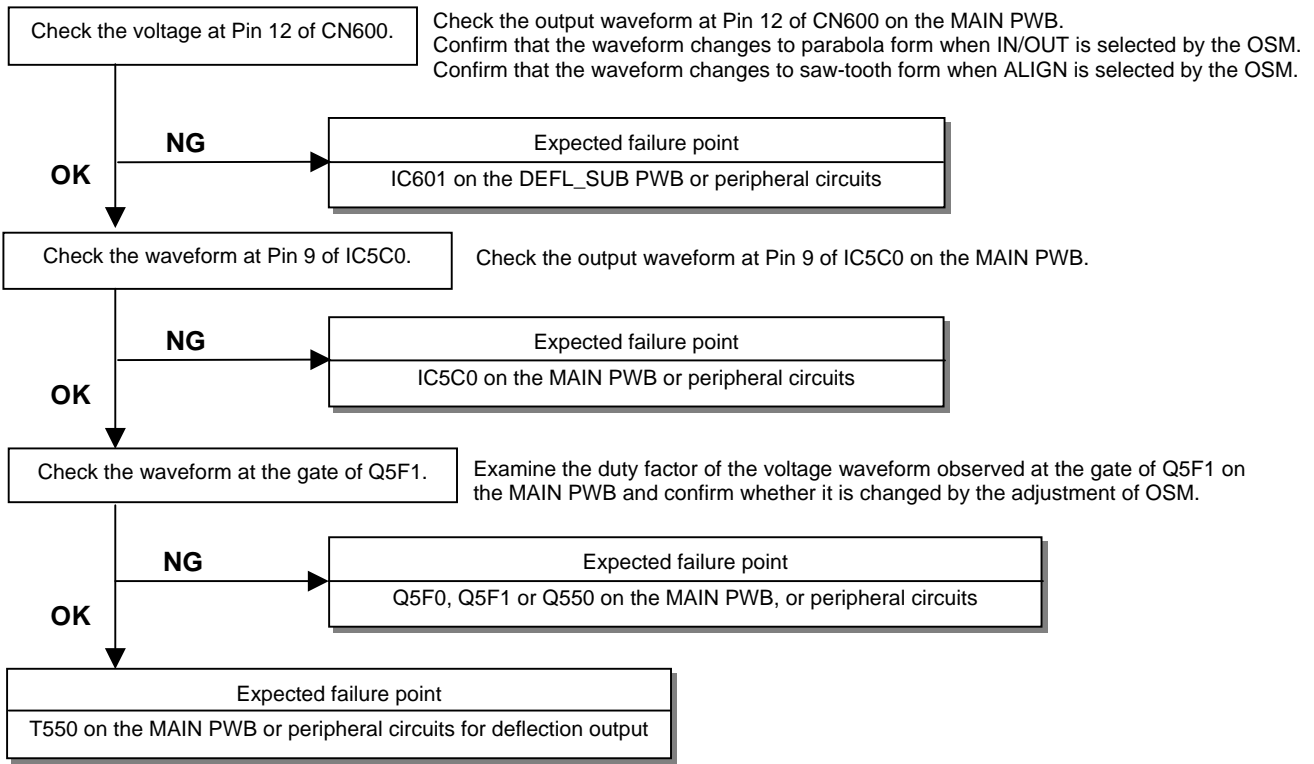

#### 3.2.6.2 LEFT/RIGHT (pincushion balance), TILT (parallelogram), and TOP BALANCE/BOTTOM BALANCE (corner correction) Failure

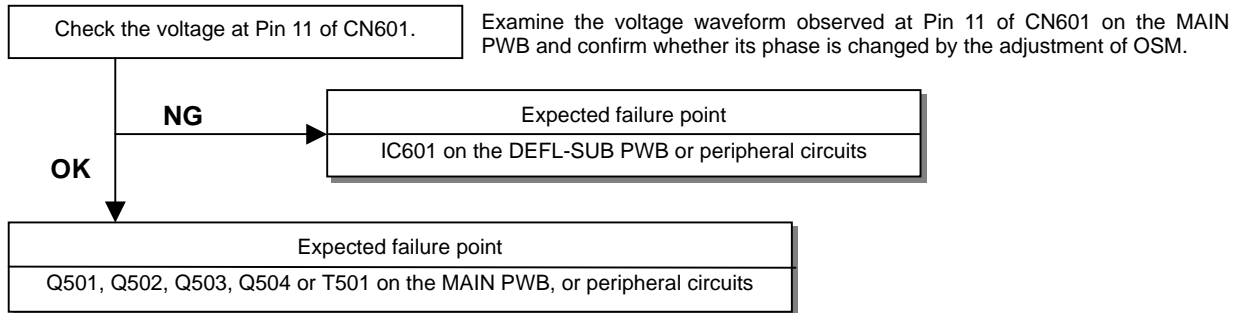

#### 3.2.6.3 ROTATE (raster rotation) Failure

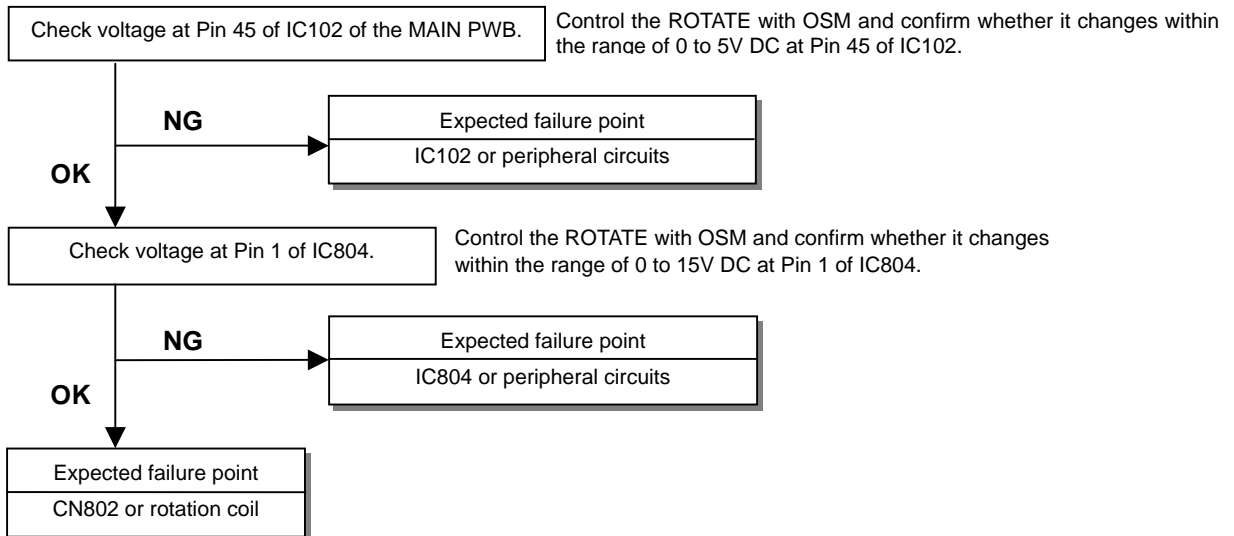

### 3.2.7 Focus Failure

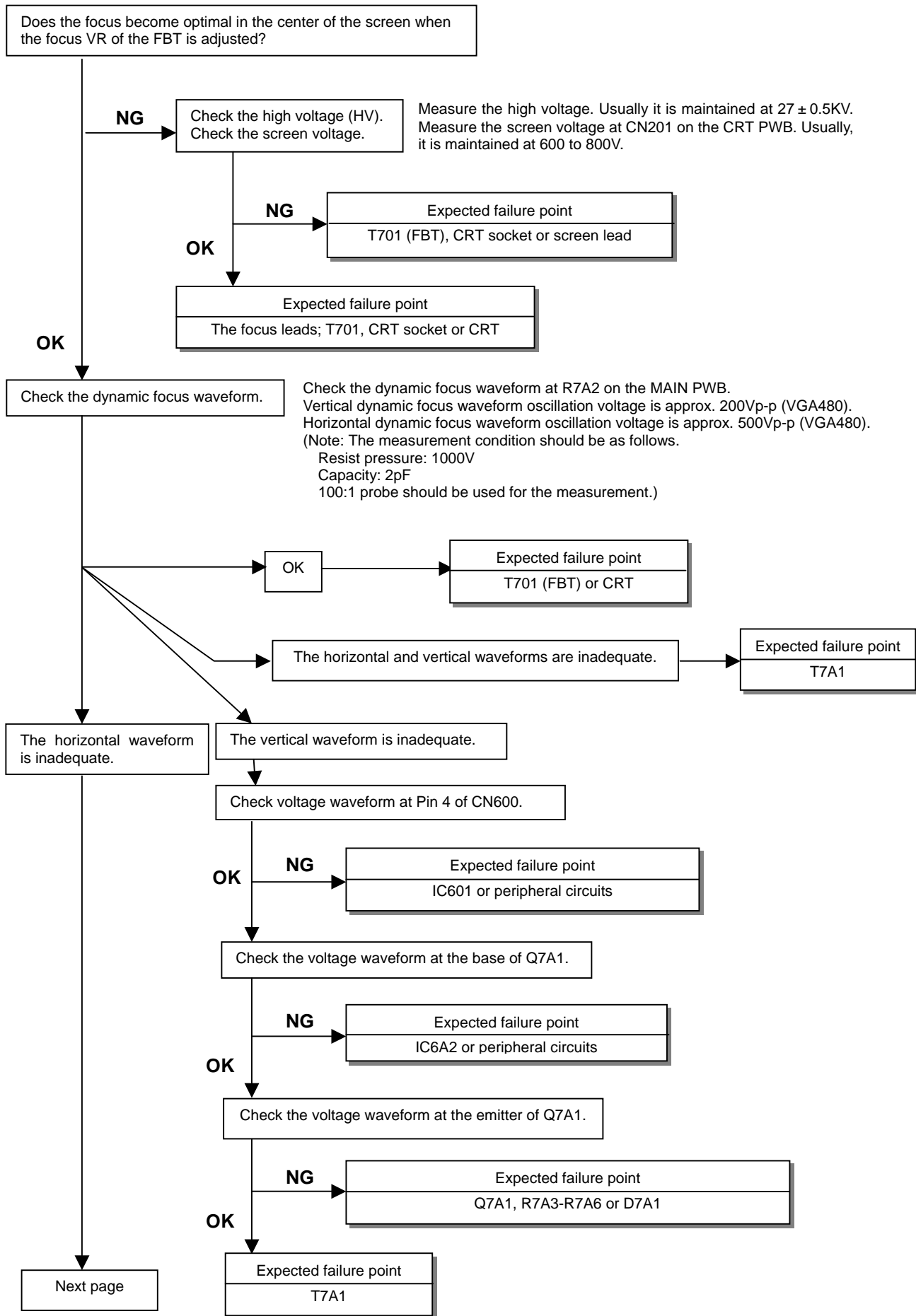

CONTINUE



The horizontal waveform is inadequate.



Check the voltage waveform at Pin 6 of CN600.



**NG**



Expected failure point  
IC601

**OK**



Check the voltage waveform at the case of Q7B5.

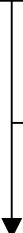

**NG**



Expected failure point  
IC6A2 or peripheral circuits



Expected failure point  
Q7B1-Q7B5 or T7A1

### 3.3 Functional Errors

#### 3.3.1 OSM Failure

Note: See “3.2 Abnormal picture” if a screen is not available even though a video signal input is entered.

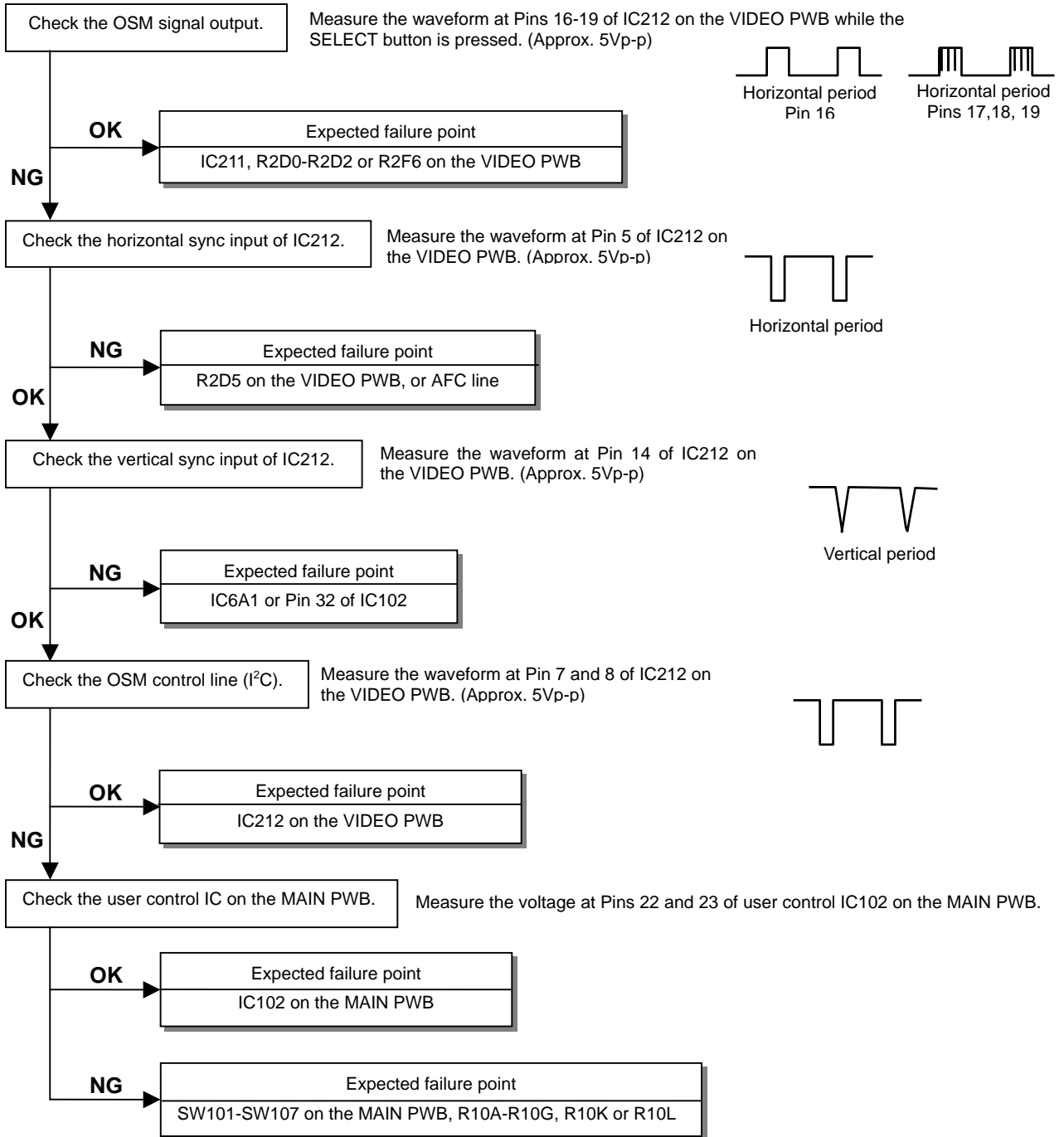

### 3.3.2 Power Management Functional Operation Error

First of all, disconnect the signal cables from the signal source.  
 (If a signal input is removed, the high voltage (HV) falls and the LED turns to ORANGE.)

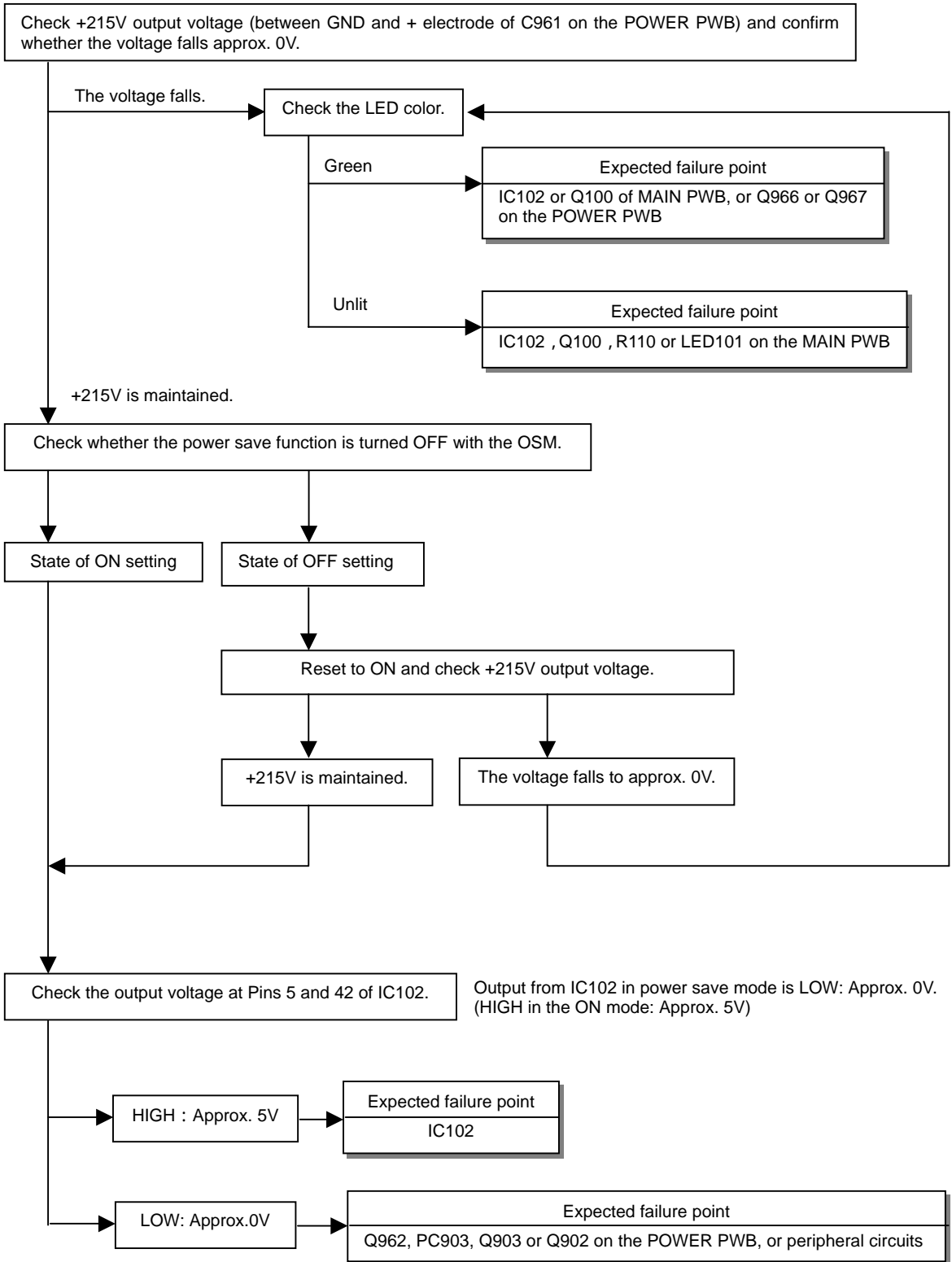



### 3.3.3 Plug & Play (DDC2B) Operation Error

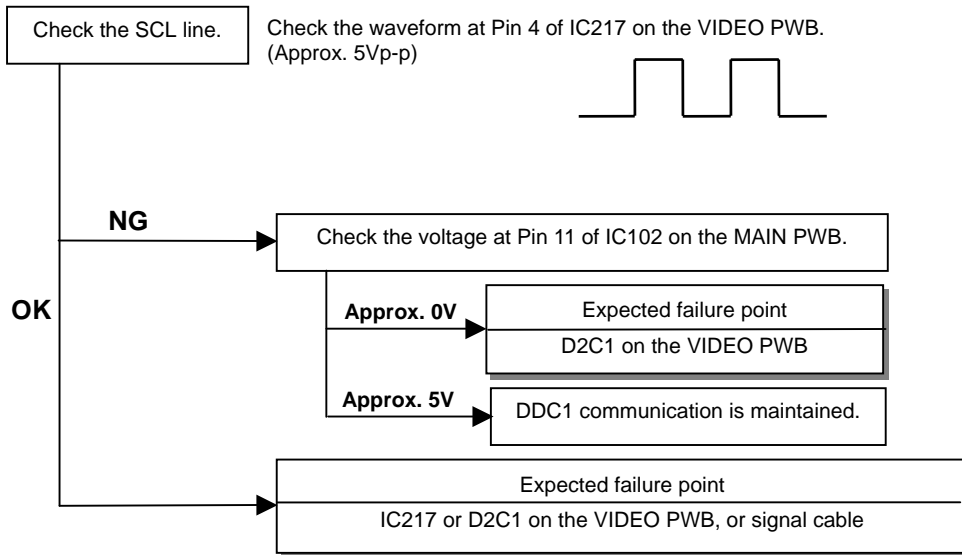

### 3.3.4 Degaussing Functional Operation Error

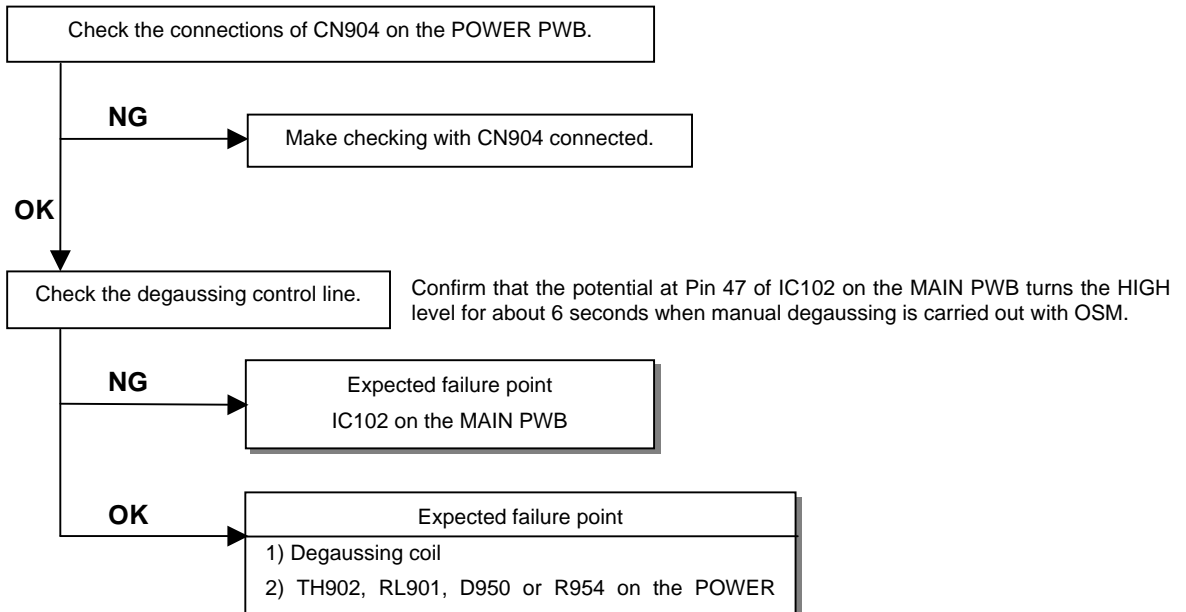

### 3.3.5 Earth Magnetism Canceling Functional Operation Error

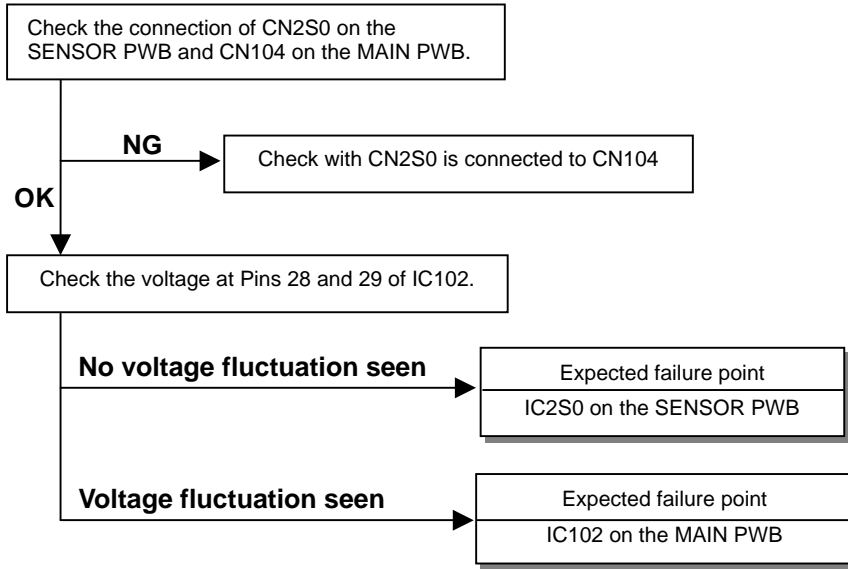

### 3.3.6 Key Operation Error

Check voltages with operation keys.

Confirm that the voltage at Pin 22 and 23 of IC102 on the MAIN PWB are as specified in the table below when the operation key is pressed.

Voltage at Pins 22 and 23 of IC102 during key operation

Pin No./Terminal name	Pin 23/KEY1	Pin 22/KEY2
EXIT (SW101) ON	5V	3.65V
◀ (SW102) ON	3.65V	5V
▶ (SW103) ON	5V	1.6V
- (SW104) ON	5V	2.38V
+ (SW105) ON	1.69V	5V
SEL (SW106) ON	5V	0V
RESET (SW107) ON	0V	5V

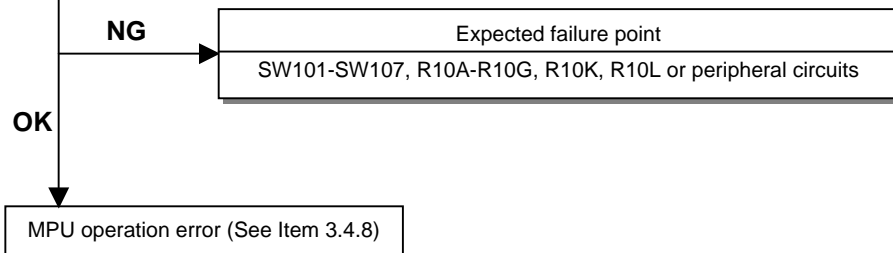

### 3.4. Circuit Errors

#### 3.4.1 Power Circuit Failure

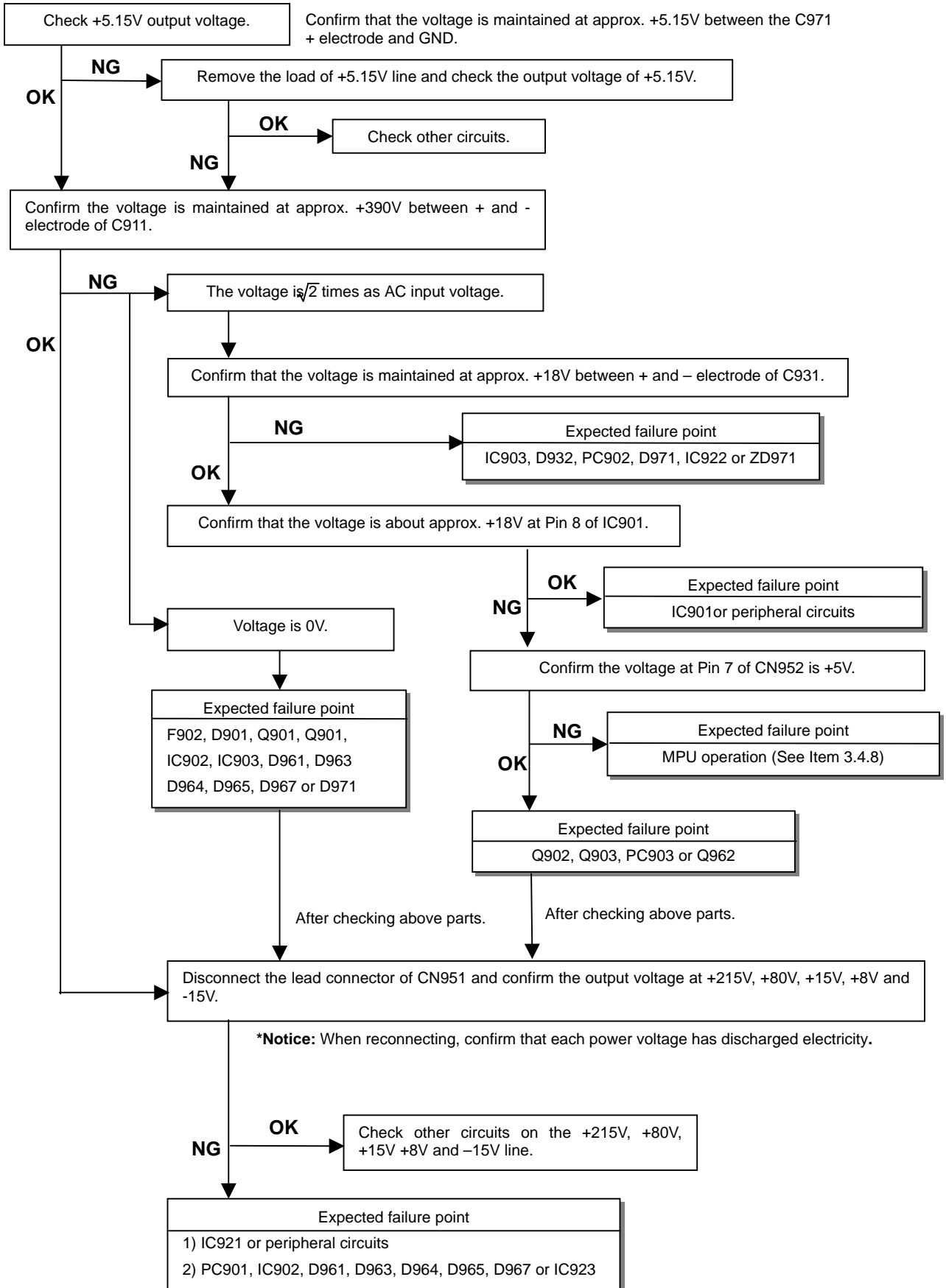

### 3.4.2 Horizontal Oscillation /Deflection Circuit Failure

(Check “3.1 No Raster Generated” and “3.2.3.1 Horizontal Sync Unstable” before this item)

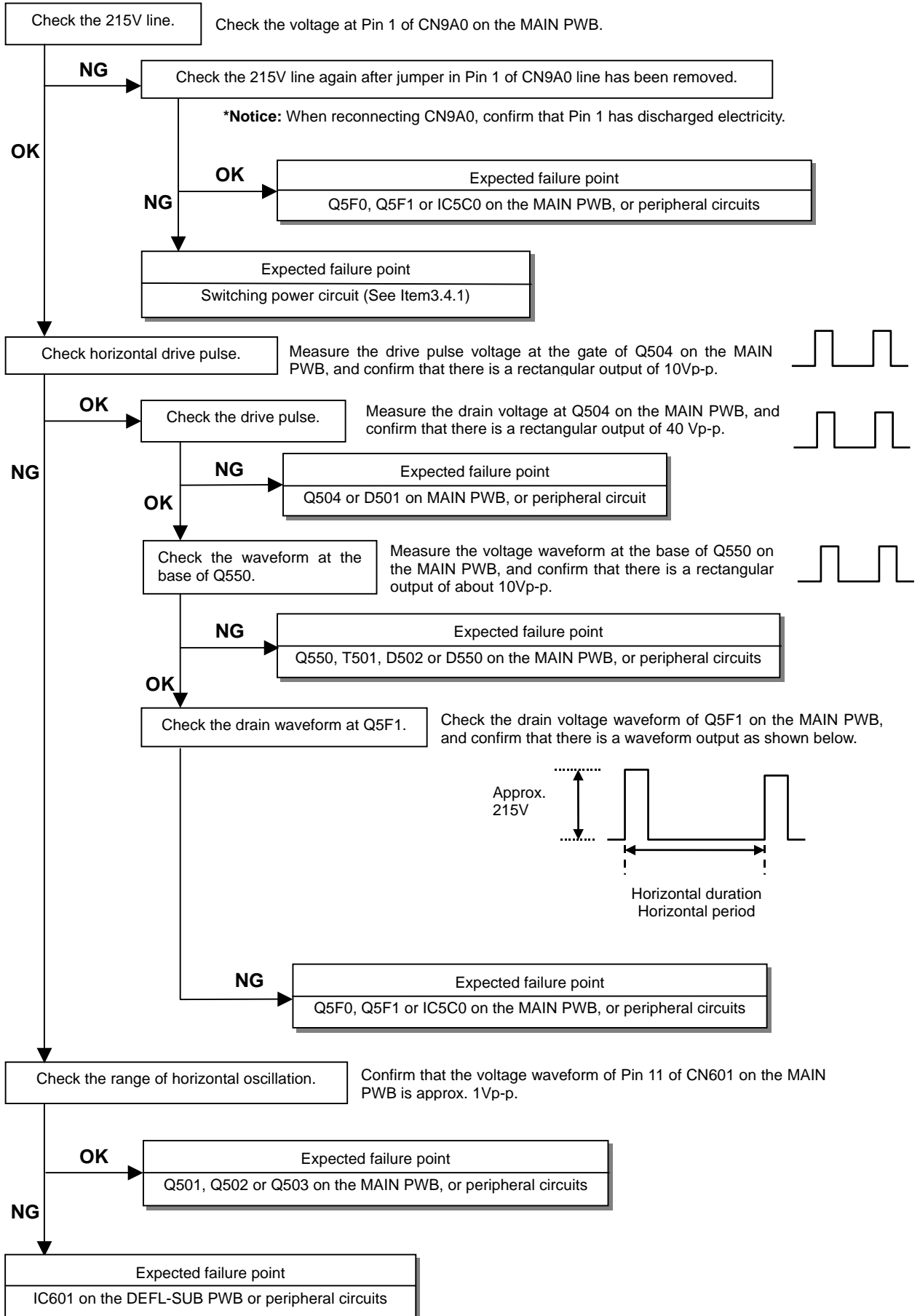

### 3.4.3 Vertical Oscillation / Deflection Circuit Failure

(Check “3.2.3.2 Vertical Sync Unstable” before checking of this item)

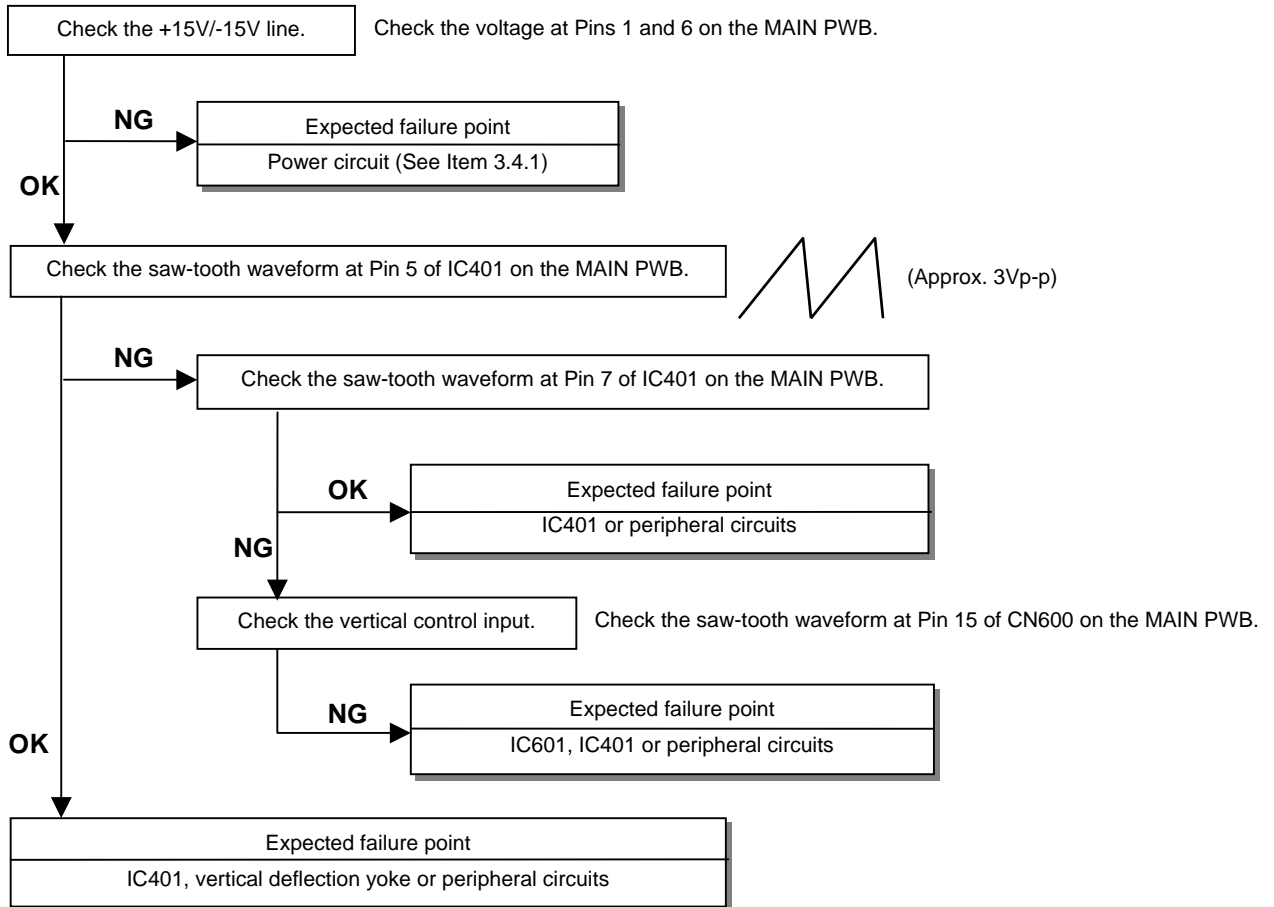

### 3.4.4 High Voltage (HV) Circuit Failure

(Check “3.1 No Raster Generated” before this item)

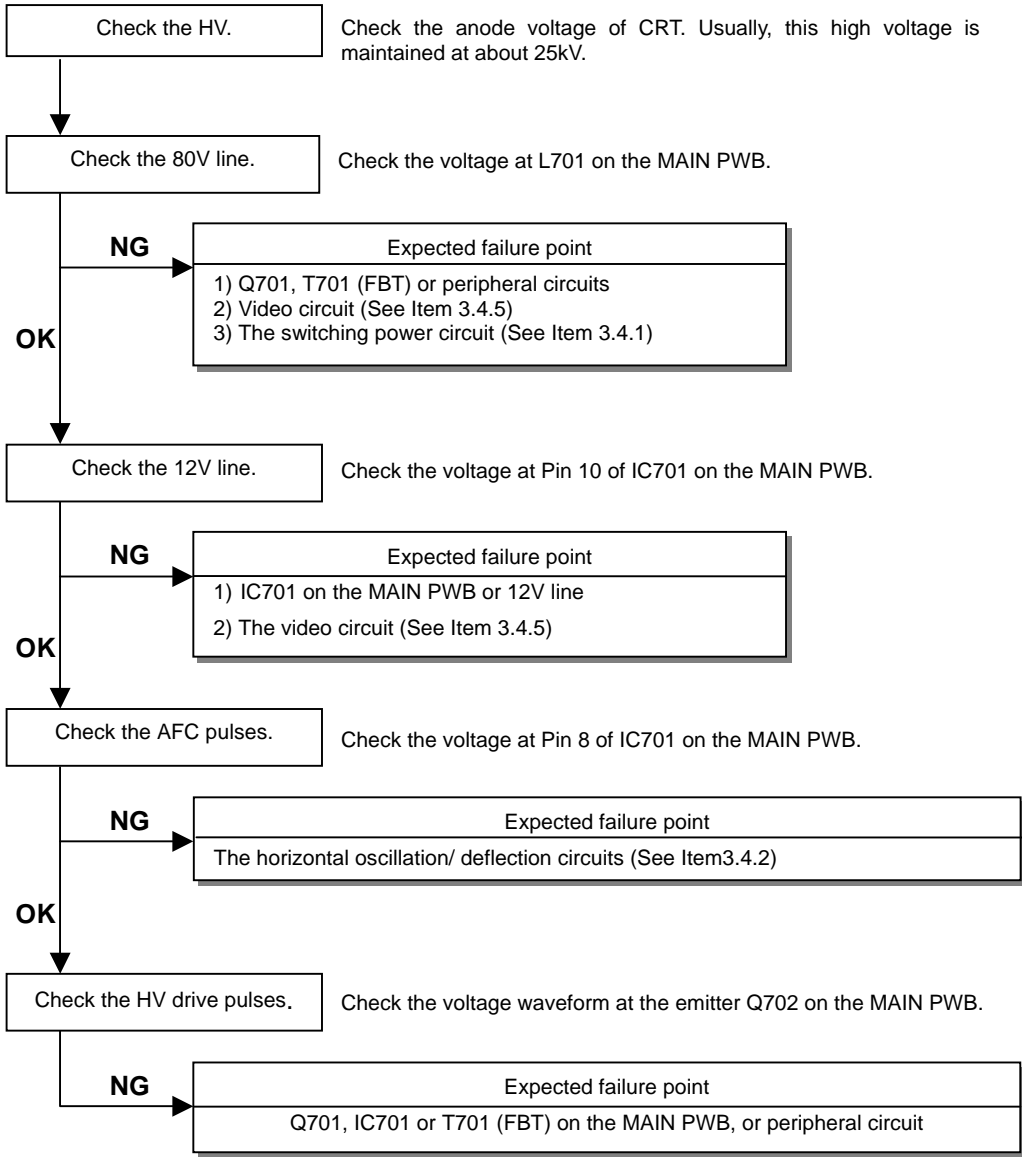

### 3.4.5 Video Circuit Failure

(Check “3.2.2 Image Color Failure or Contrast Failure” before this item)

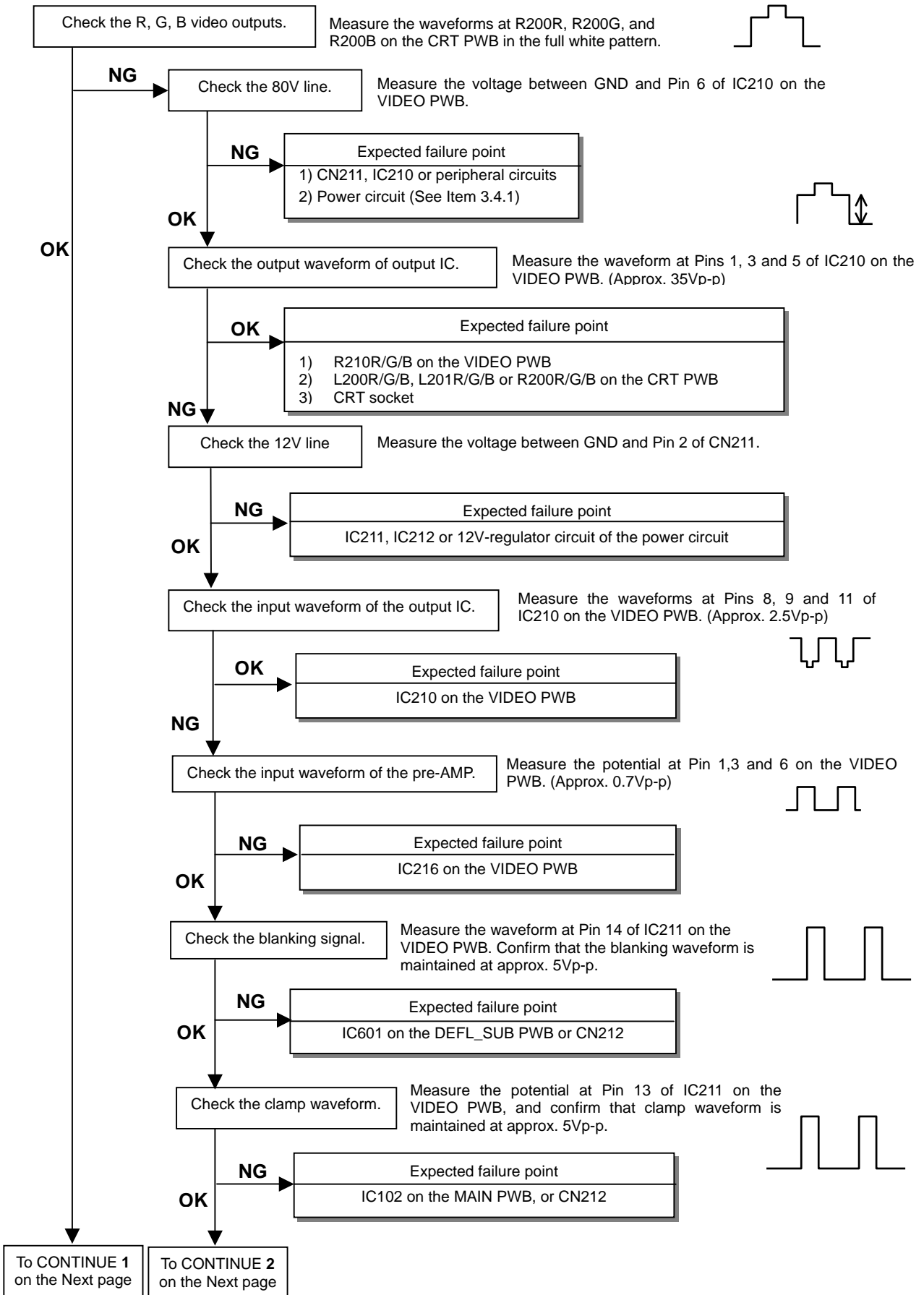

CONTINUE 1

CONTINUE 2

Check the output waveform of pre-AMP.

Measure the waveform at R/G/B output Pins 25, 27 and 29 of IC211 on the VIDEO PWB.

NG

Expected failure point  
IC211 on the VIDEO PWB

OK

Expected failure point  
L211R/G/B or R211R/G/B

Check the R, G, B video outputs.

Measure the voltage waveform at R200R/G/B on the CRT PWB, and confirm whether BLACK LEVEL voltage is maintained at approx. 60-90V.

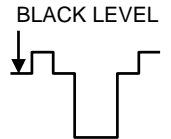

NG

Check the 215V line.

Measure the voltage between GND and + electrode of C260.

OK

NG

Expected failure point  
CN211 or 215V line of power circuit

OK

Check the voltage of C210R/G/B on the VIDEO PWB.

Confirm the voltage is approx. 60-100V.

NG

Confirm the voltage at the base of R250R/G/B is approx. 6V.

OK

Expected failure point  
L200R/G/B or L201R/G/B

OK

Expected failure point  
R261, D264, R260 or peripheral circuits

OK

Expected failure point  
Q250R/G/B or Q251R/G/B

Check the HV operation.

Confirm whether the HV is  $27 \pm 0.5KV$ .

NG

Expected failure point  
The HV circuit (See Item 3.4.4)

OK

Check the heater voltage.

Measure the voltage at both terminals of C203H on the CRT PWB. Usually, the voltage is approx. 6.3V.

NG

Expected failure point  
1) CN211  
2) The switching power circuit (See Item 3.4.1)

OK

Check the screen control of FBT.

Confirm the voltage of R205S on the CRT PWB is approx. 600-800V.

NG (too low)

Expected failure point  
T701 on the MAIN PWB or CRT socket on the CRT PWB

OK

Expected failure point  
CRT



### 3.4.6 Static Convergence Compensation Circuit Failure

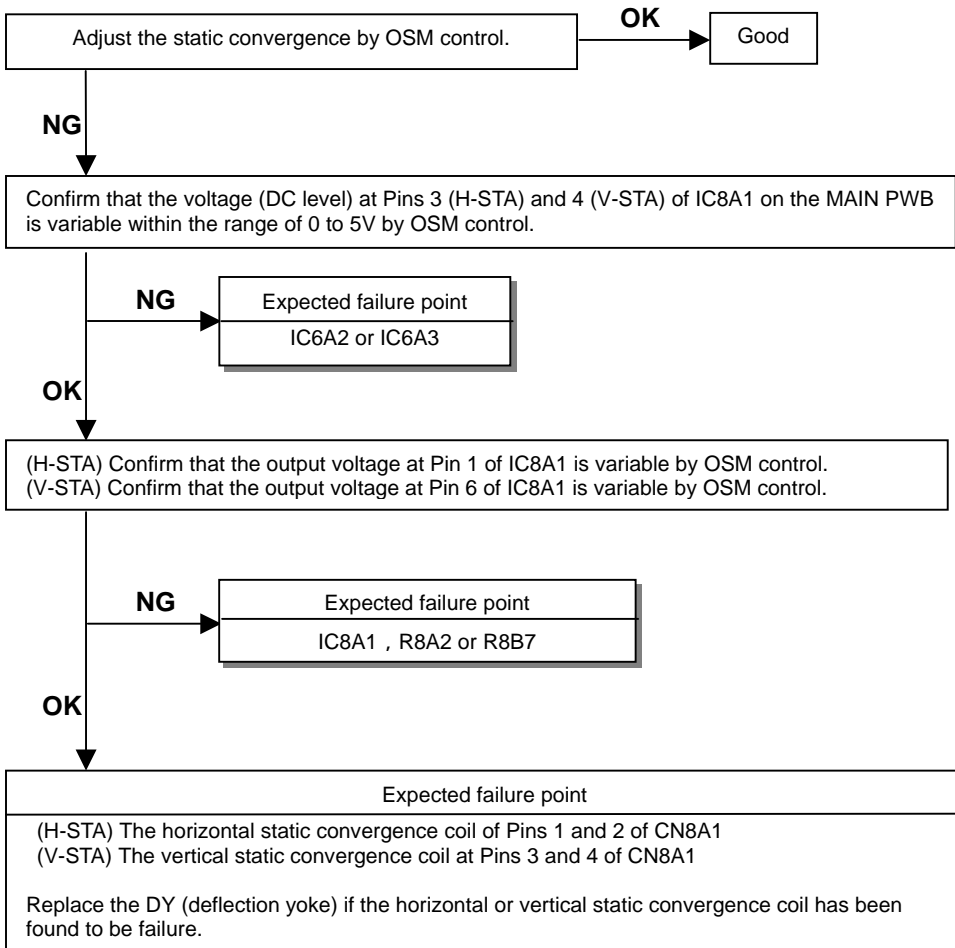

### 3.4.7 Corner Purity Compensation Circuit Failure

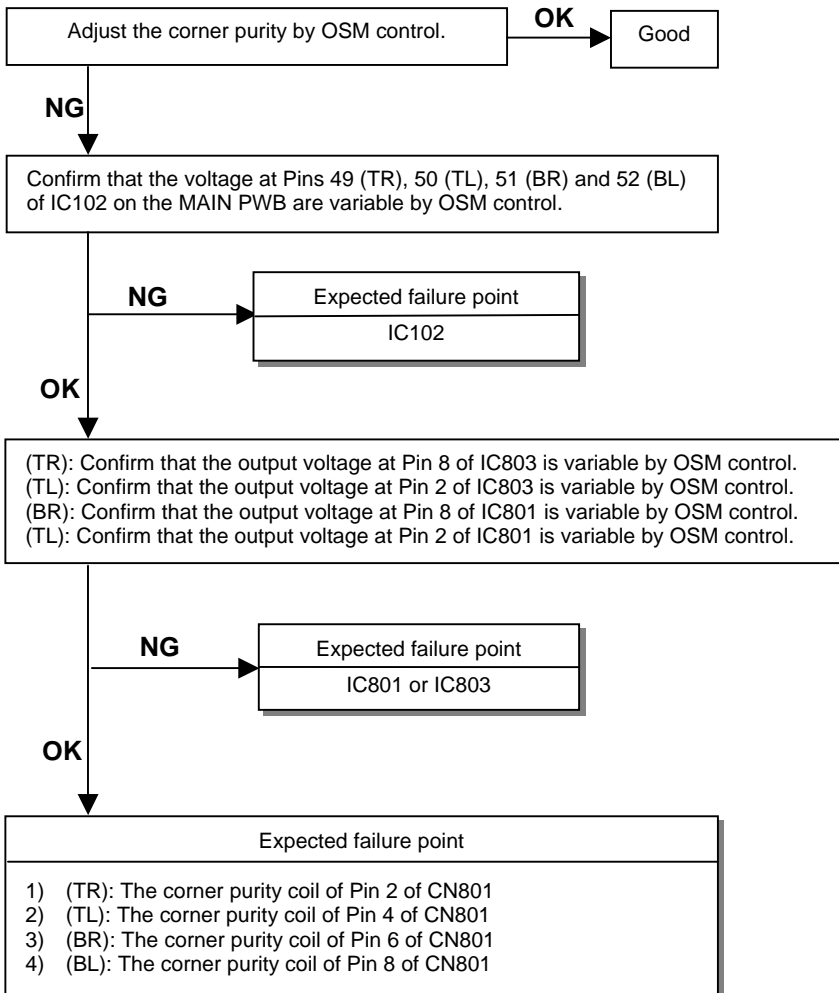

### 3.4.8 MPU Operation Error

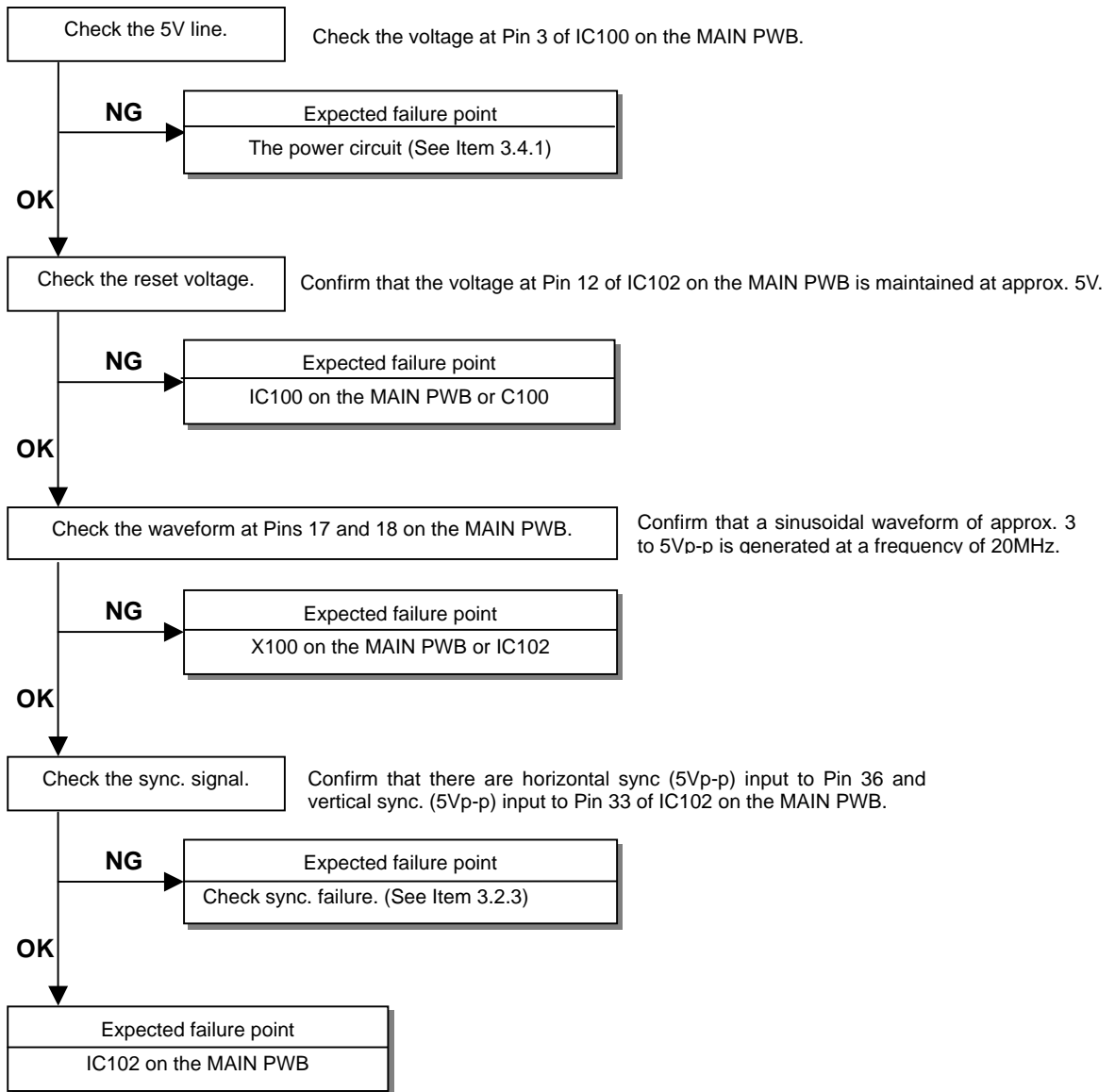

### 3.4.9 Self-Diagnostic Functions

This model is provided with the functions that a circuit error is detected by the MPU and this error is indicated by the LED blink frequency.

When the protector is in operation, the LED is made to blink as shown below in order to indicate the factor of protector operation.

LED Blinking Patterns for Each Protector Operation (List of Protector Indicators)

Protector condition	LED condition	
	Short (0.5s) lighting frequency	Long (2s) lighting frequency
HV data error	3	1
HV latch (fall)	2	1
Beam protector	5	1
Secondary power short	7	
X-lay protector	1	1

(1) How to count the LED lighting frequency [Example: HV data error (3 times)]

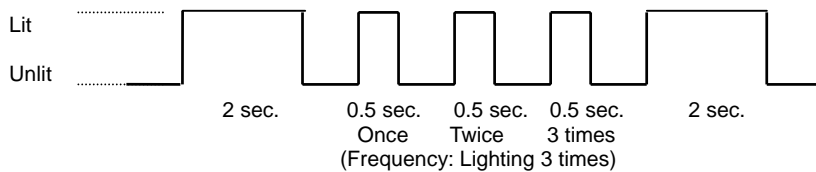

(2) Diagnostic mode and error circuit

- 3 times --- HV data error ----- Power OFF/ON and data recovery  
(HV adjustment value is destroyed or IC104 is failure).
- 2 times --- HV latch (falls) ----- Check Item 3.4.4
- 5 times --- Beam protector ----- Check Item 3.4.4
- 6 times --- Secondary power short ----- Check Item 3.4.1

### 3.4.10 USB Circuit Failure

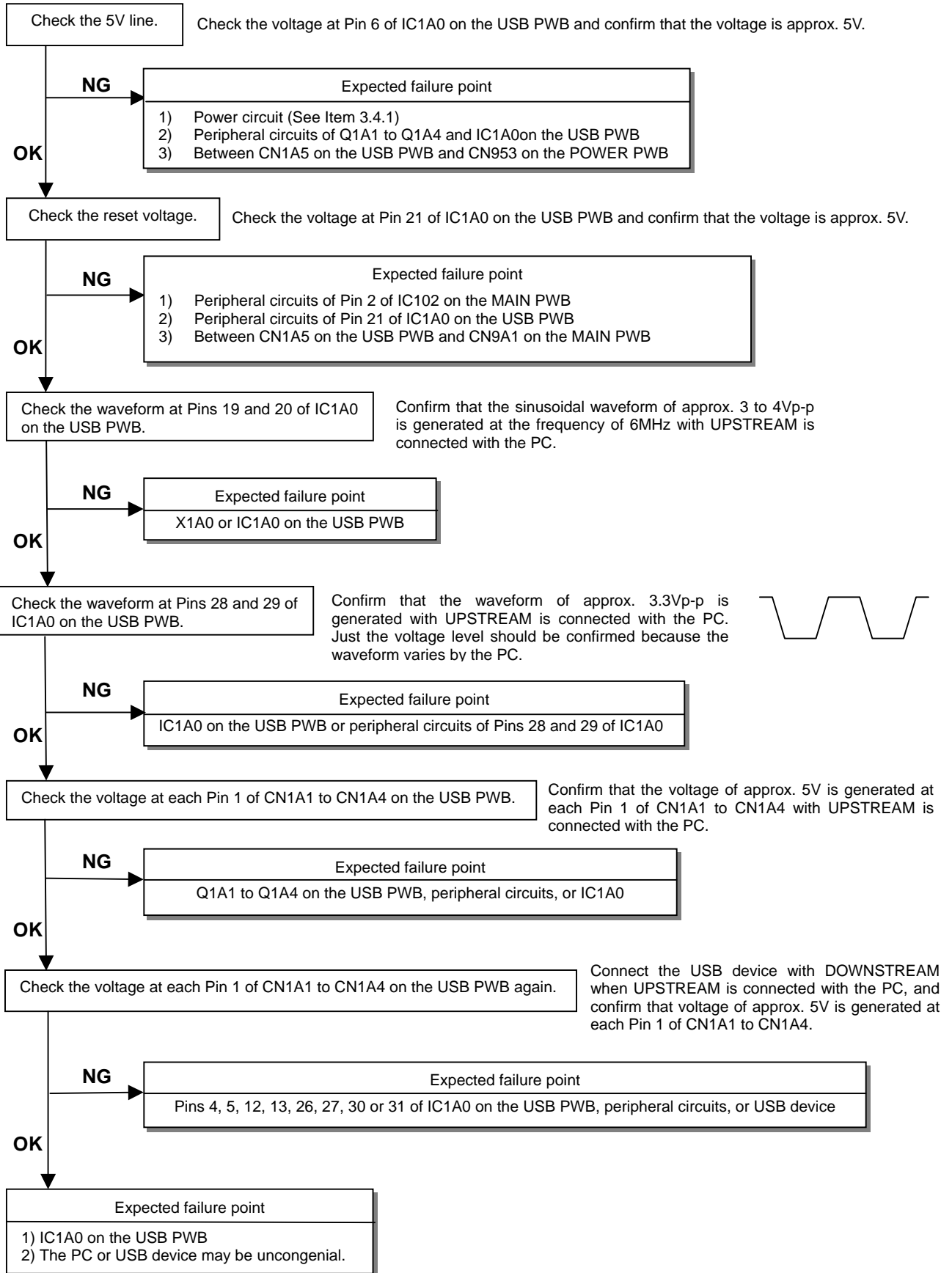

# 5. Schematic diagram

1. POWER
2. CONTROL (MAIN)
3. DEFL (MAIN)
4. DEFL-SUB & COIL-DRIVE (MAIN)
5. DEFL-SUB
6. VIDEO
7. USB-HUB
8. V-6H
9. SENSOR
10. CRT

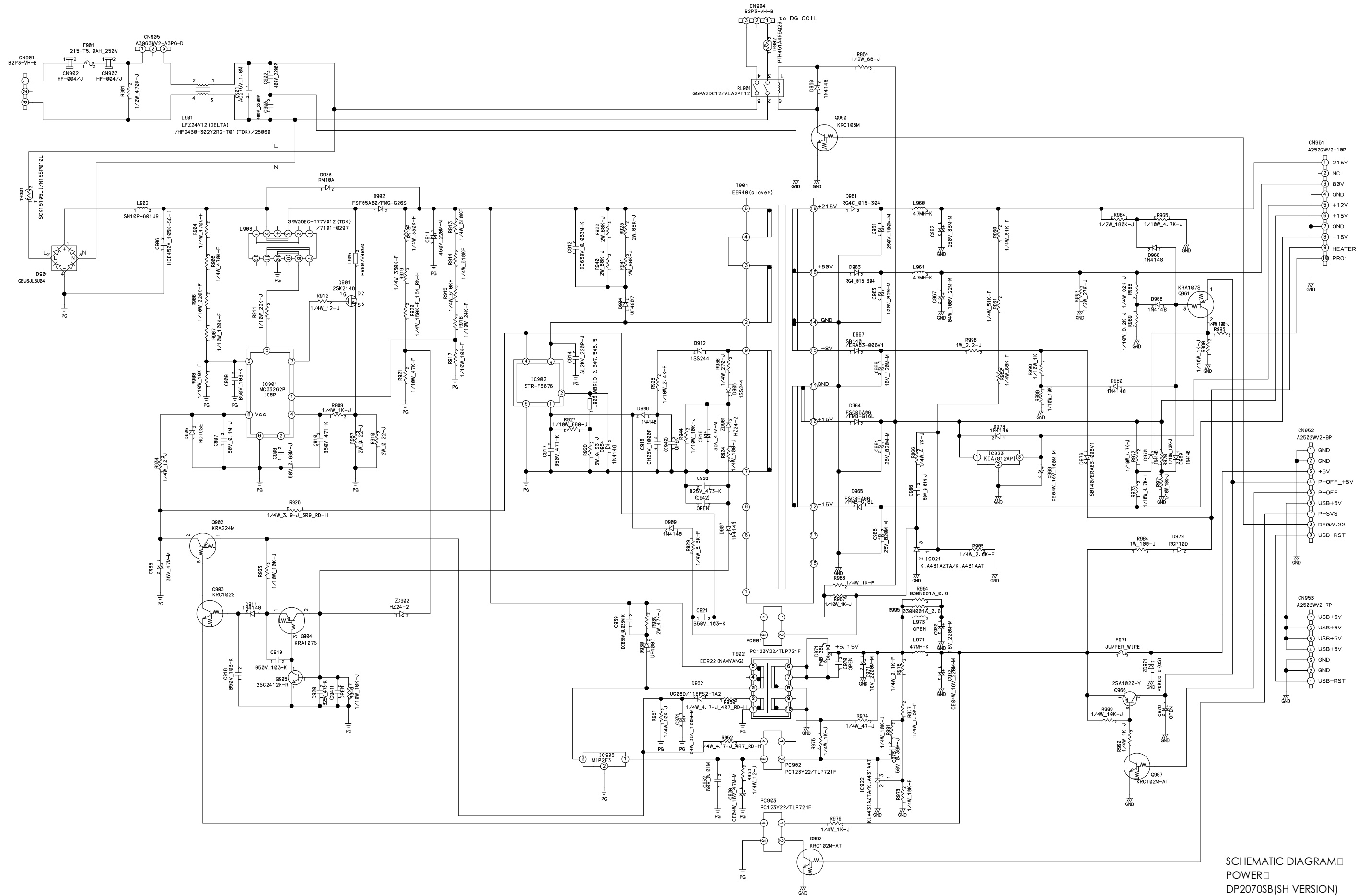

SCHEMATIC DIAGRAM □  
 POWER □  
 DP2070S(SH VERSION)

chassis	IC102	R140	R151	R11F	C122
C22BW701/C22BW711	HD64F2128PS20	1/BW 0ohm	O	X	O
C22BW701 ONLY	HD6432128SWA04PS VD201	OPEN	O	X	O
C22BW701/C22BW711	HD6432128SWA05PS VD301	OPEN	O	X	O
C22BW711 (South)	HD6432128SWA05PS VD301	OPEN	X	O	X

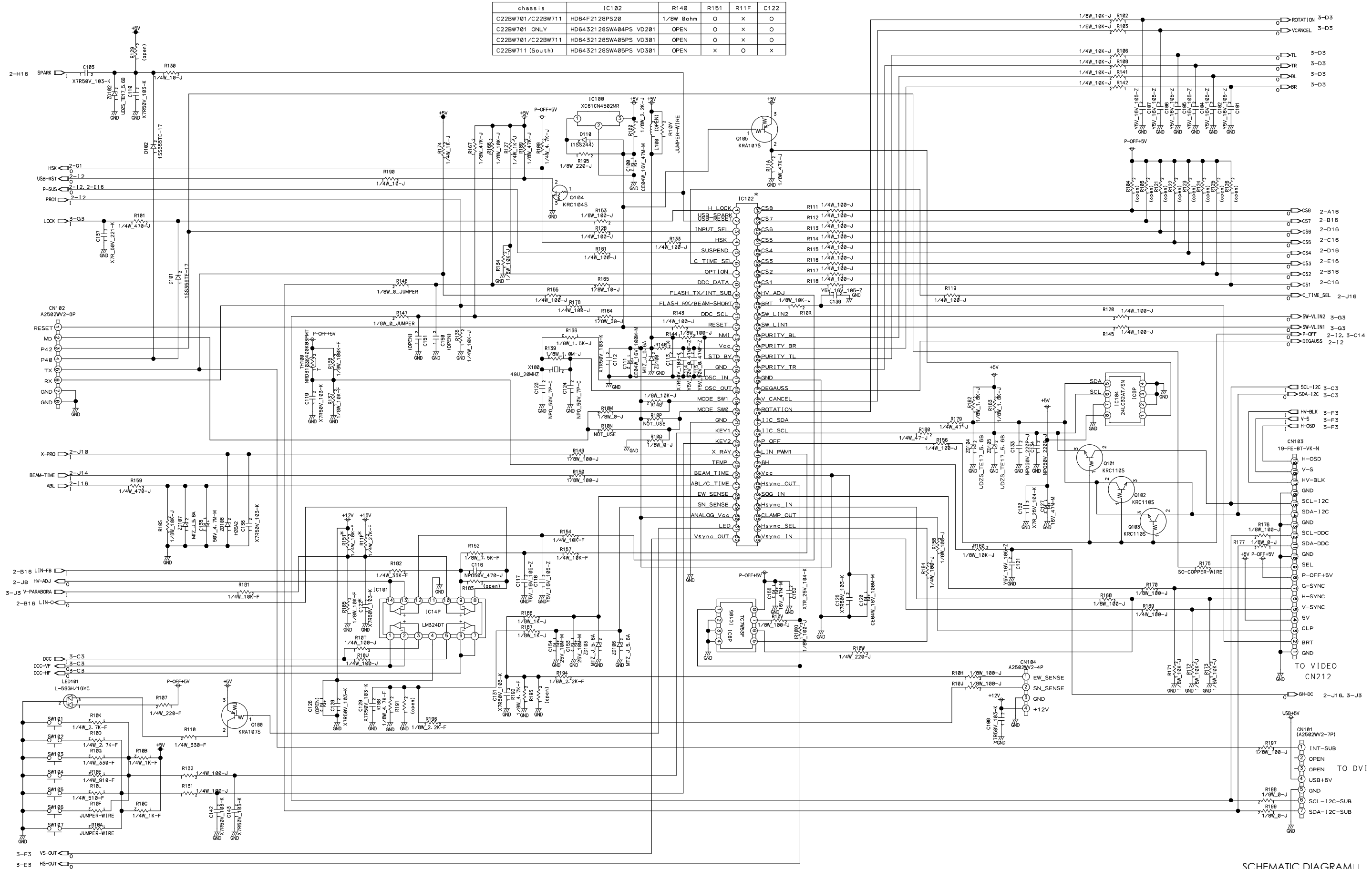

SCHEMATIC DIAGRAM □  
CONTROL (MAIN) □  
DP2705B (SH VERSION)



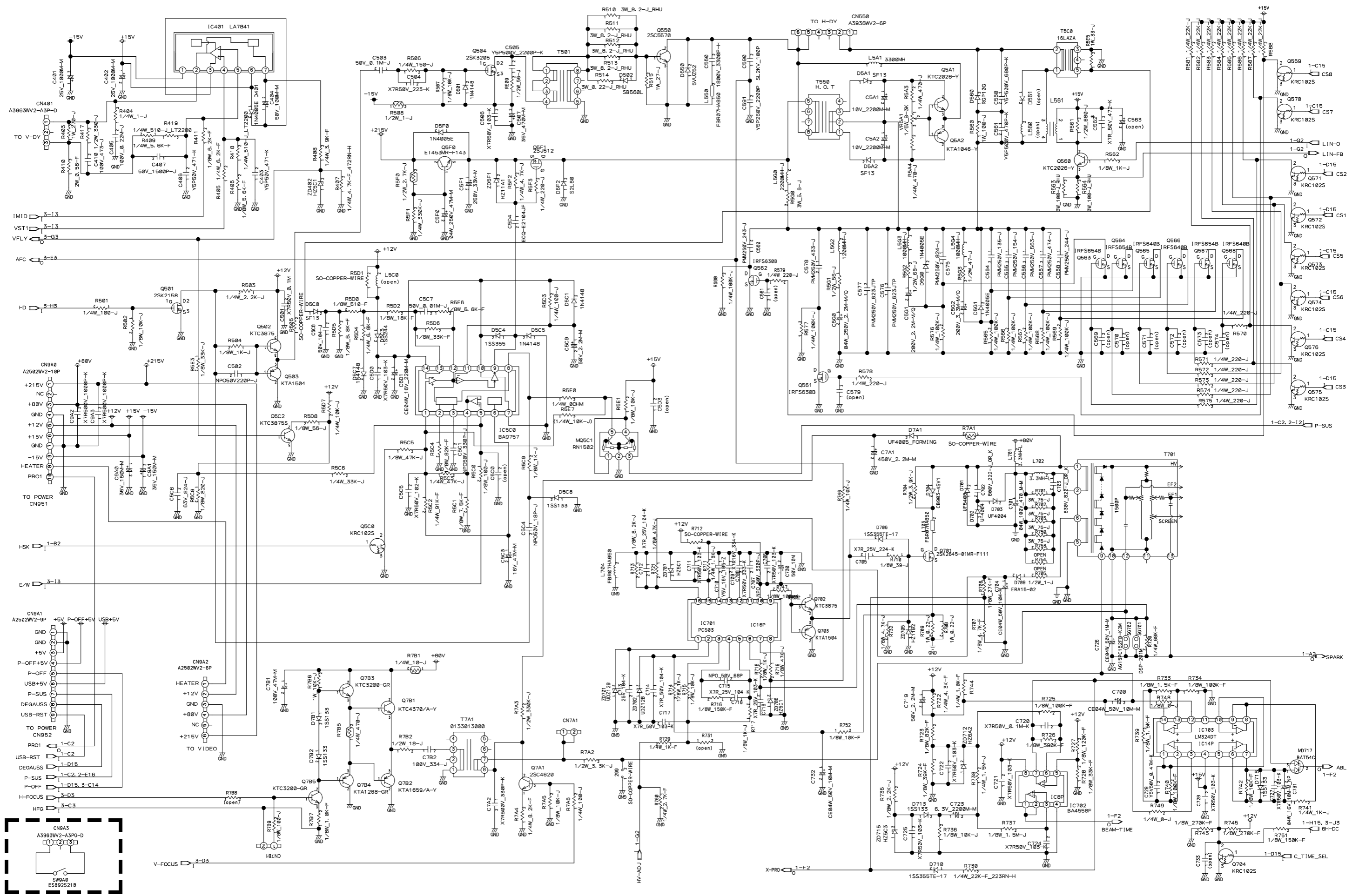

chassis	C562
C22BW701	O
C22BW711	O
C22BW711 (South)	X

SCHEMATIC DIAGRAM □  
 DEFL (MAIN) □  
 DP2070SB(SH VERSION)

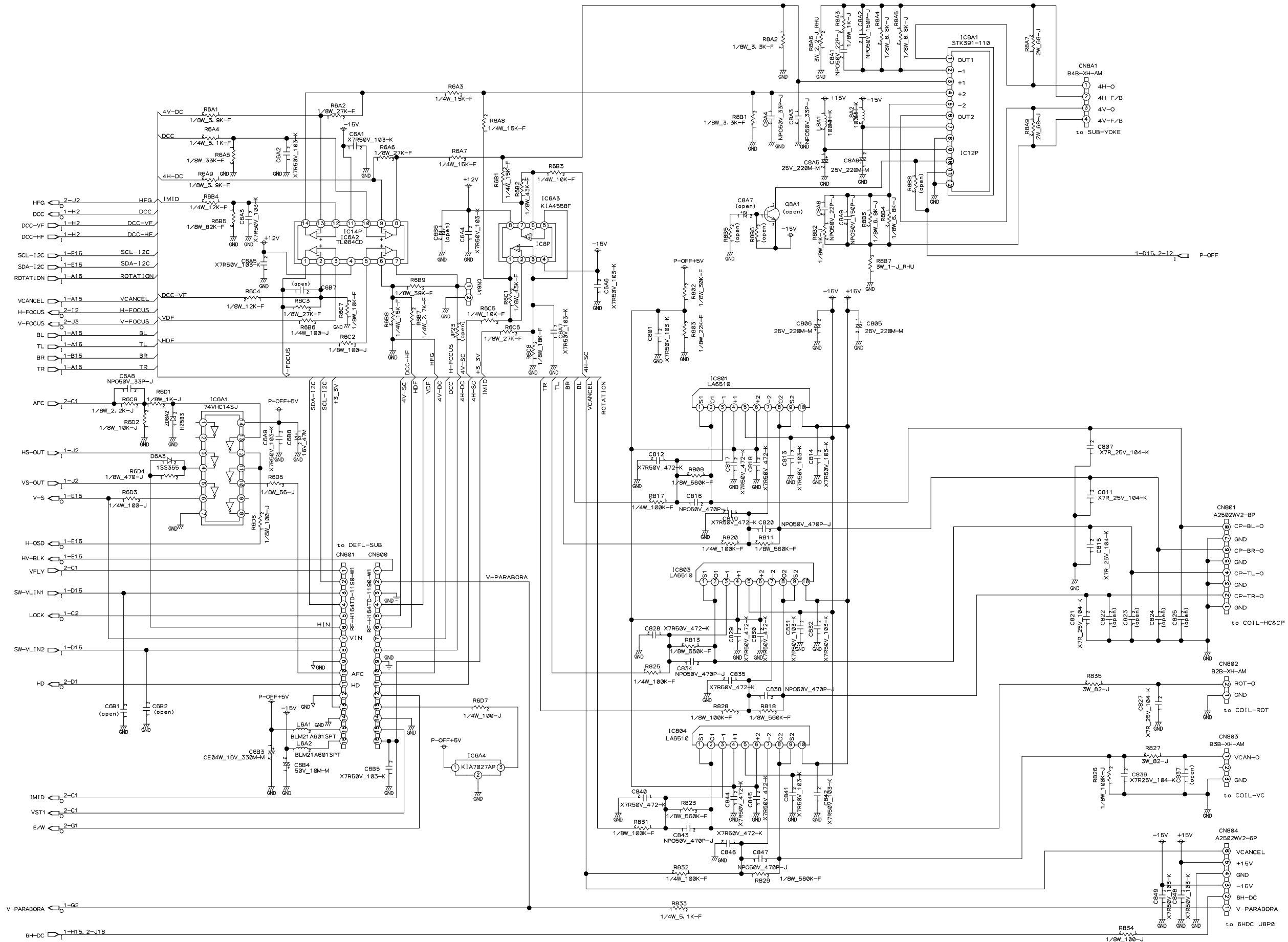

- \*6A0~ uPD61882
- \*800~ DDCP\_OUT
- \*8A0~ COIL\_DRIVE

SCHEMATIC DIAGRAM □  
 DEFL-SUB&COIL-DRIVE (MAIN) □  
 DP2070SB(SH VERSION)

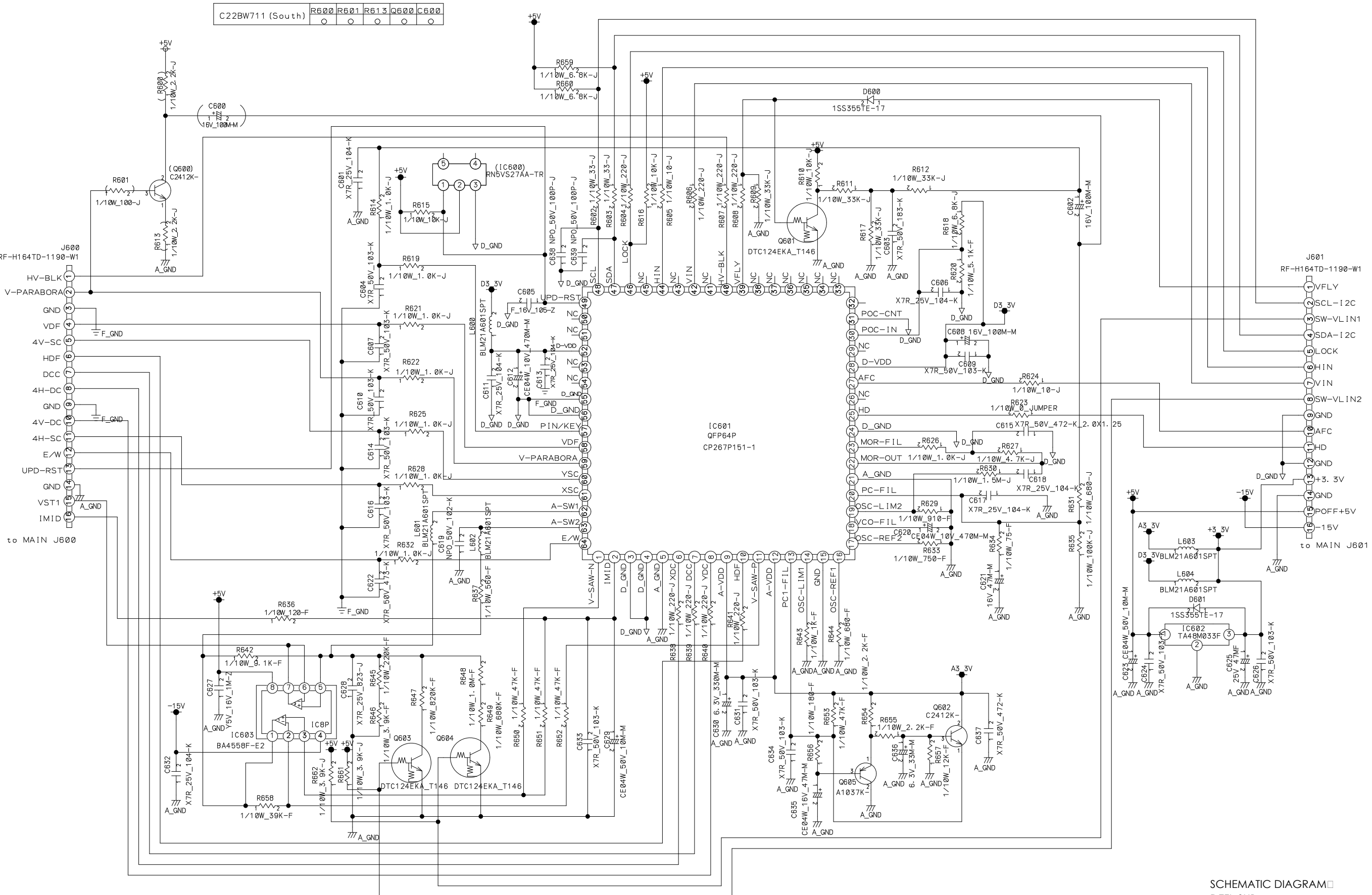

SCHEMATIC DIAGRAM □  
 DEFL-SUB □  
 DP2070SB(SH VERSION)

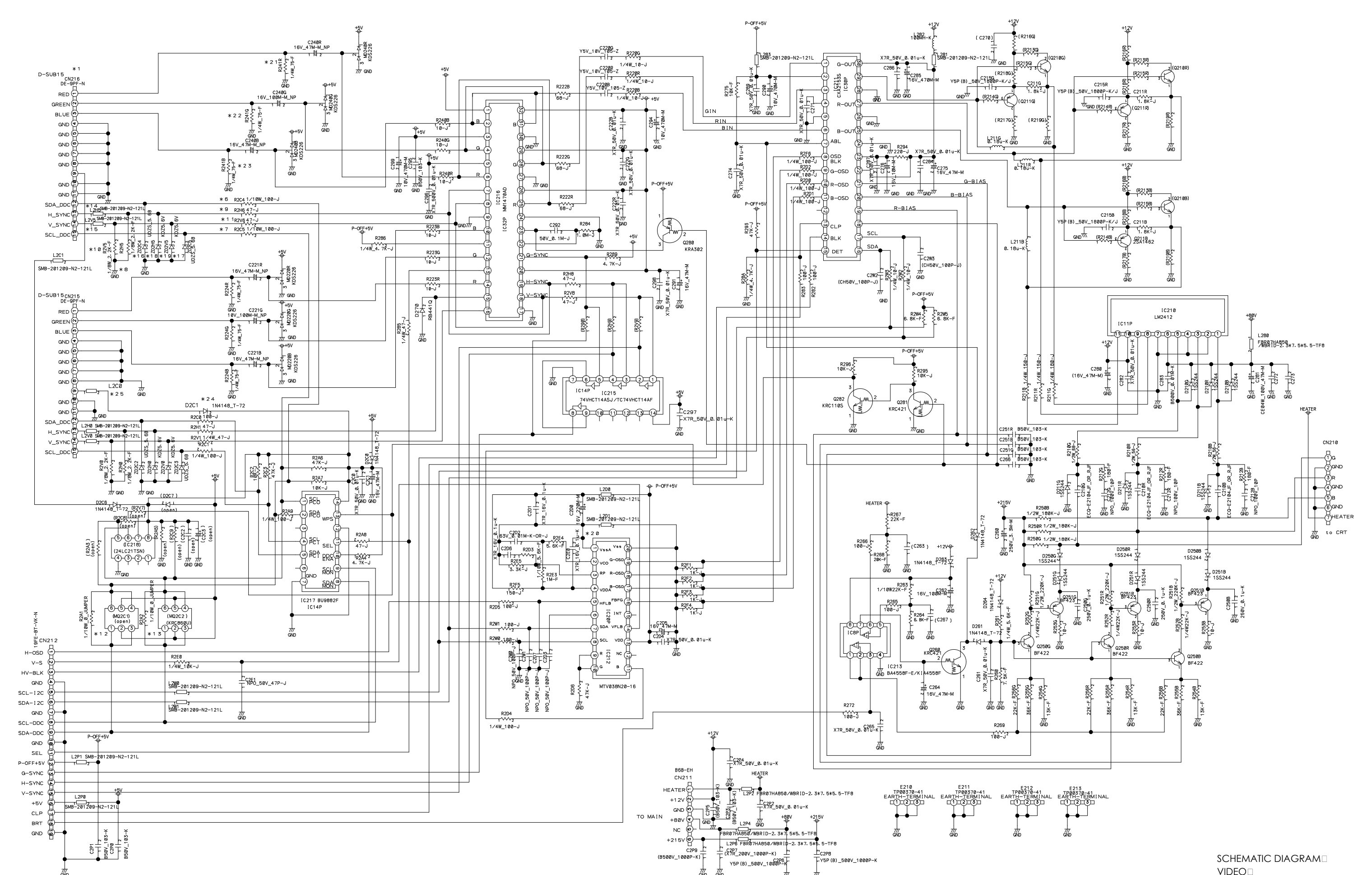

No Voltage Description Resistor: 1/8 CHIP

SCHEMATIC DIAGRAM  
VIDEO  
DP2070SB(SH VERSION)

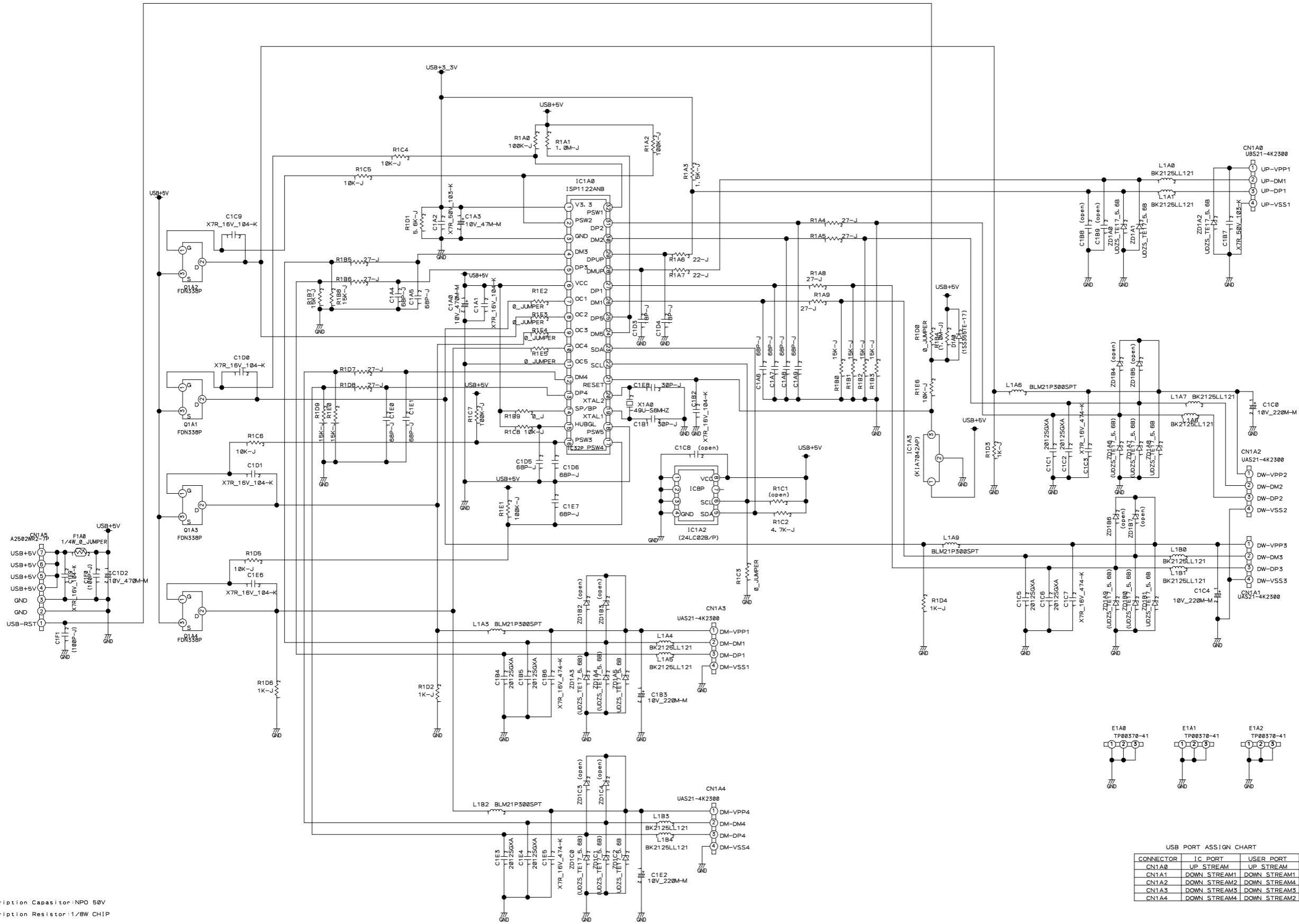

No Description Capacitor:NPO 50V  
 No Description Resistor:1/8W CHIP

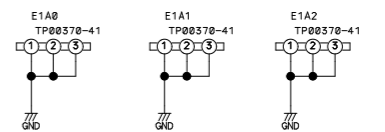

USB PORT ASSGN CHART

CONNECTOR	IC PORT	USER PORT
CN1A0	UP_STREAM	UP_STREAM
CN1A1	DOWN_STREAM1	DOWN_STREAM1
CN1A2	DOWN_STREAM2	DOWN_STREAM4
CN1A3	DOWN_STREAM3	DOWN_STREAM3
CN1A4	DOWN_STREAM4	DOWN_STREAM2

SCHEMATIC DIAGRAM □  
 USB-HUB □  
 DP2070SB(SH VERSION)

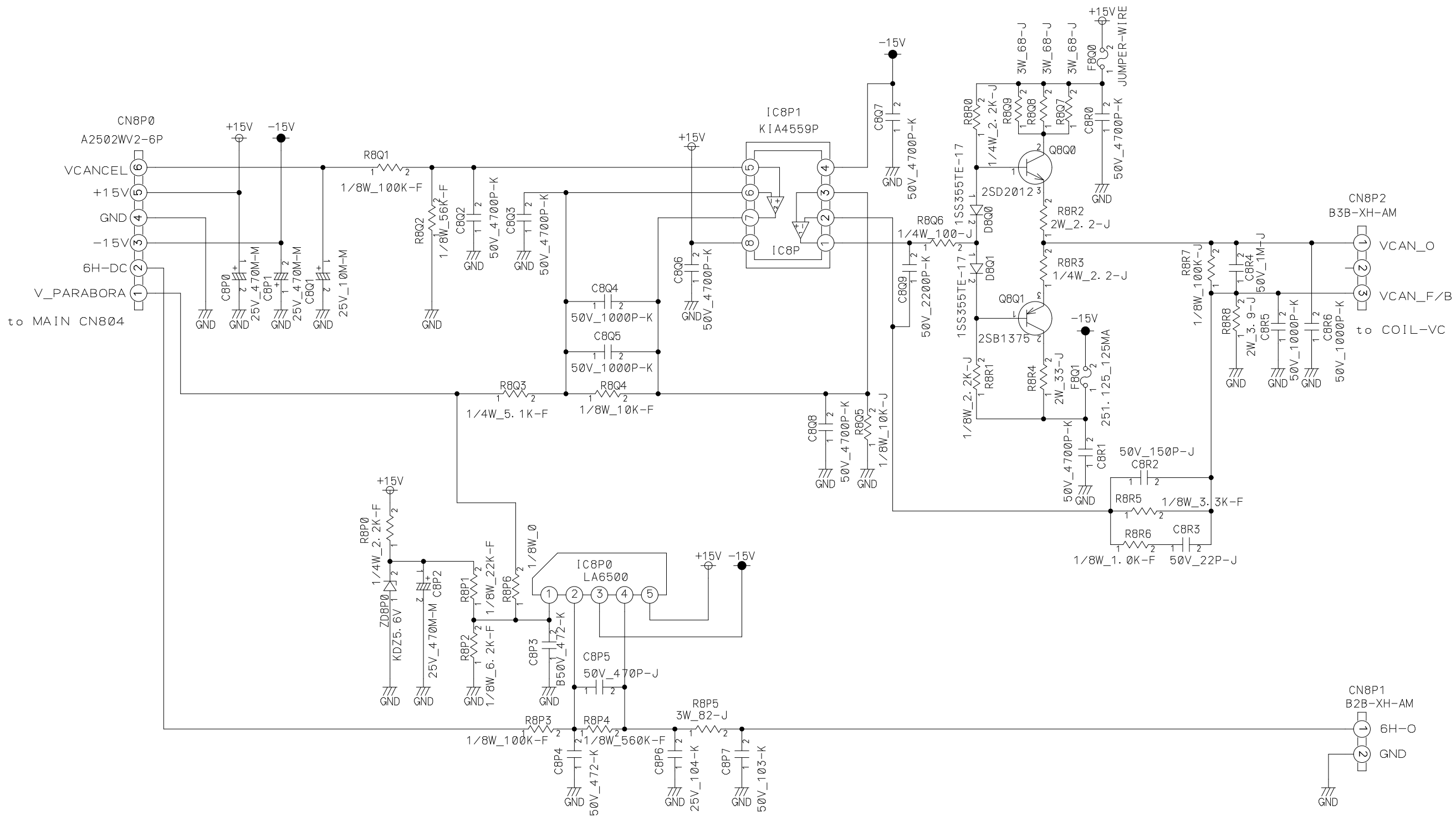

SCHEMATIC DIAGRAM  
 V-6H  
 DP2070SB(SH VERSION)

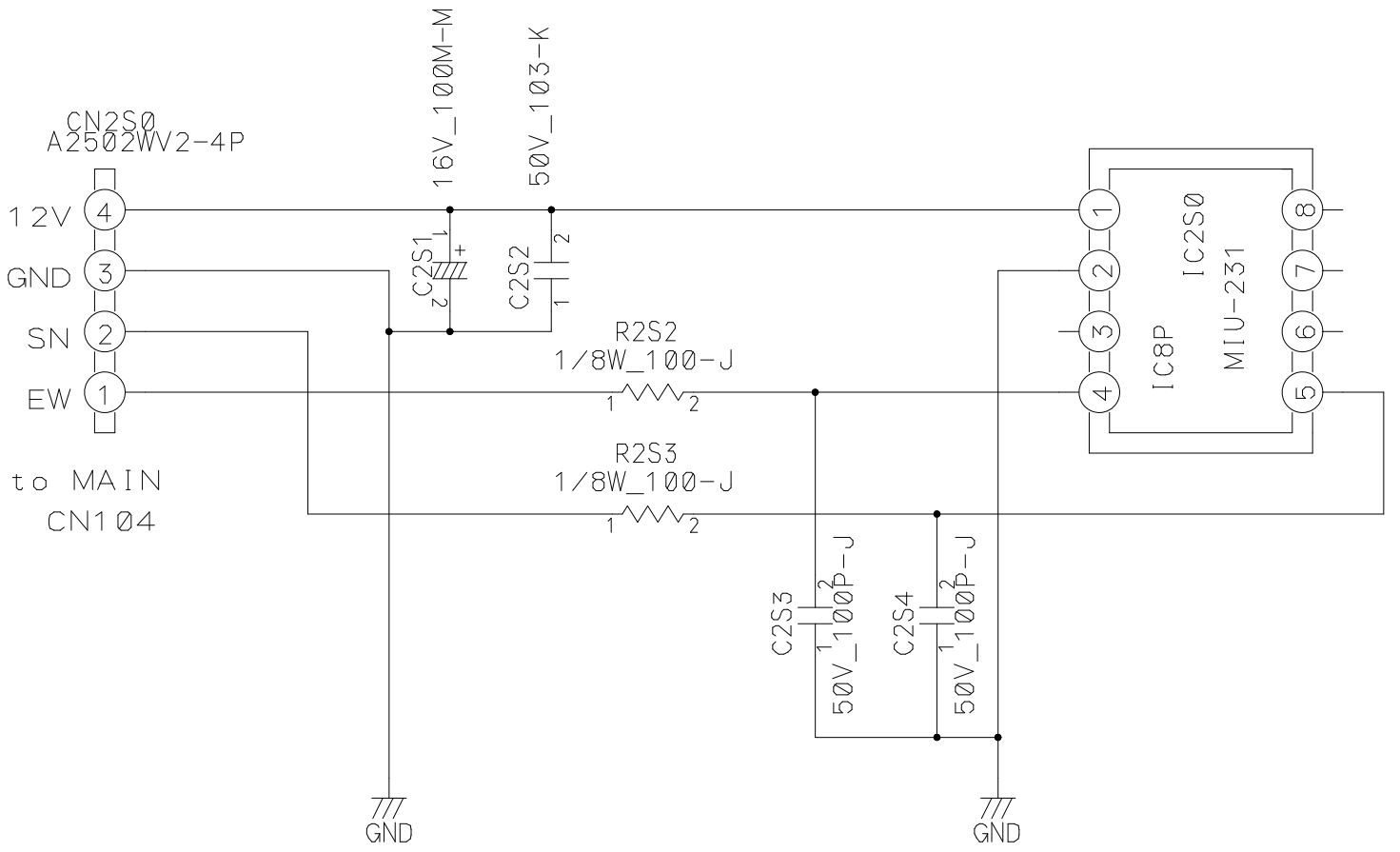

SCHEMATIC DIAGRAM □  
 SENSOR □  
 DP2070SB(SH VERSION)

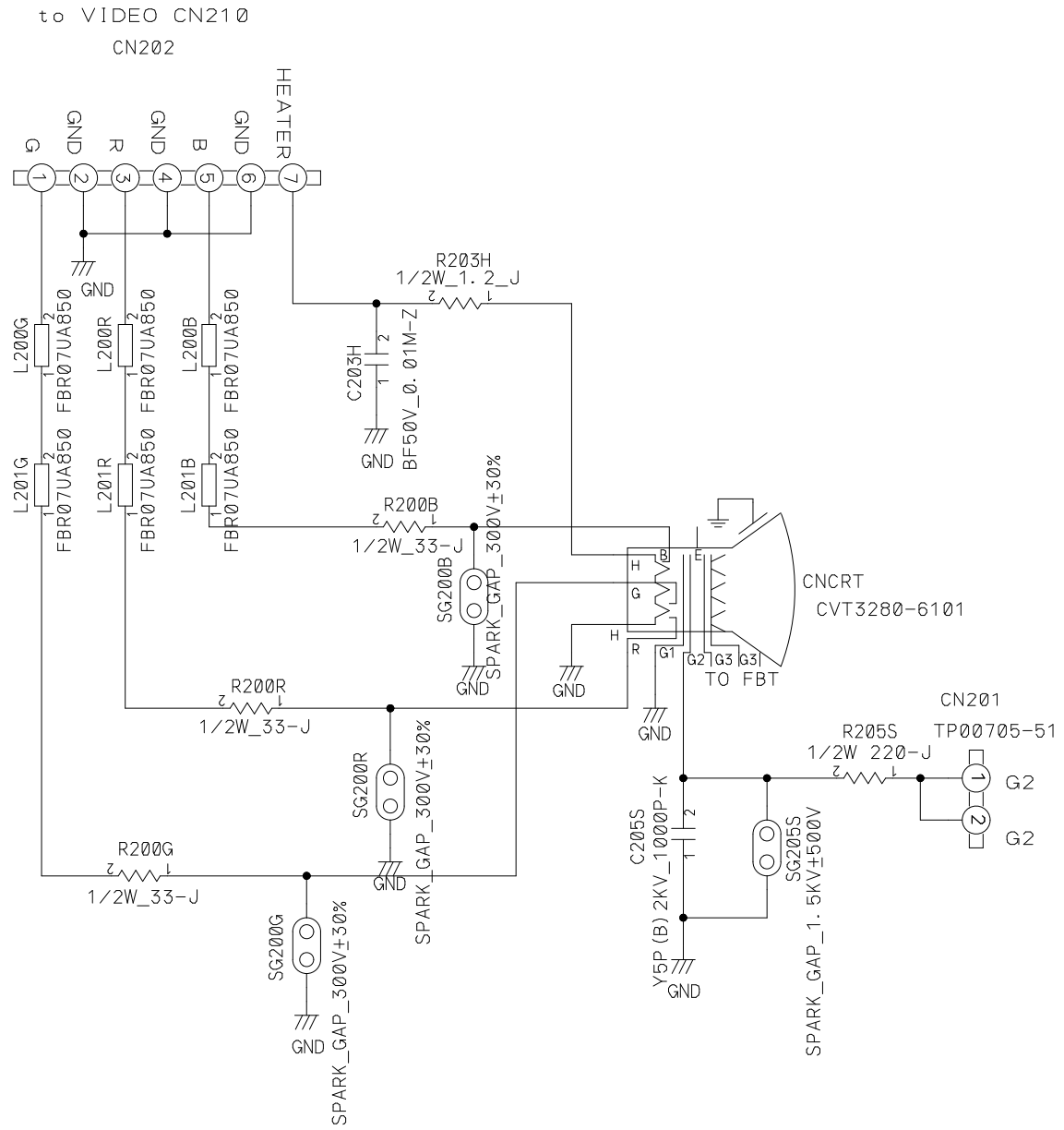

SCHMATIC DIAGRAM □  
CRT □  
DP2070SB(SH VERSION)



# 6. Removal Instruction Sheet of Bezel and Back cover

## 1. Introduction

Please prepare jig for removal.

- Please use as a jig what turned up about 20~30 mm of tapes for crack prevention and stuck them on the tip of a steel board with approx. a thickness of 0.5~0.8 mm a width of 15mm, and a length of 150 mm. (As the example, we used ruler made from steel as shown in photograph.)



## 2. Structure Details of Bezel and Back Cover

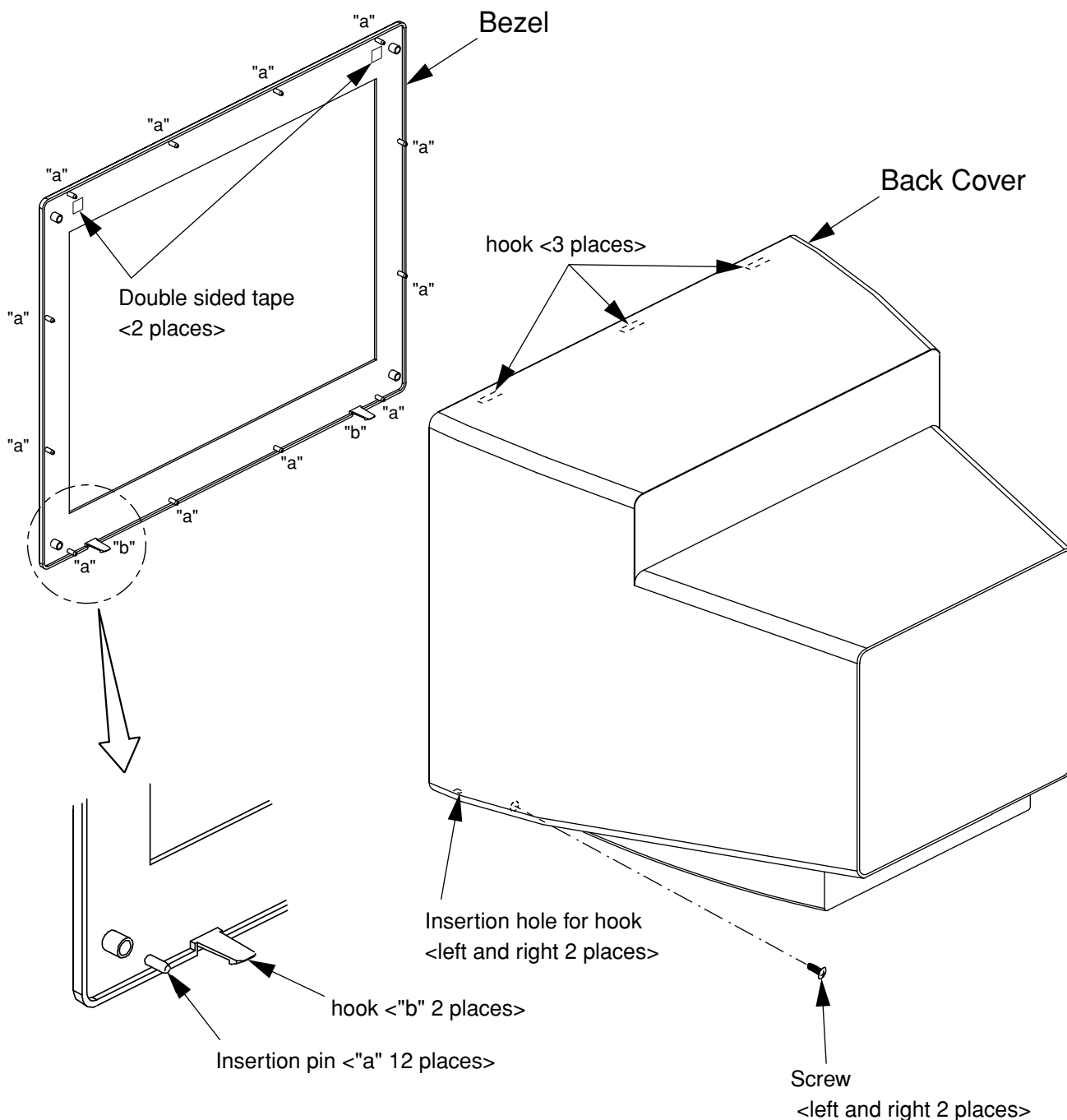

### 3. Removal Instruction for Bezel

(1) A jig is inserted in the center of the Bezel upper part, and it pushes out.

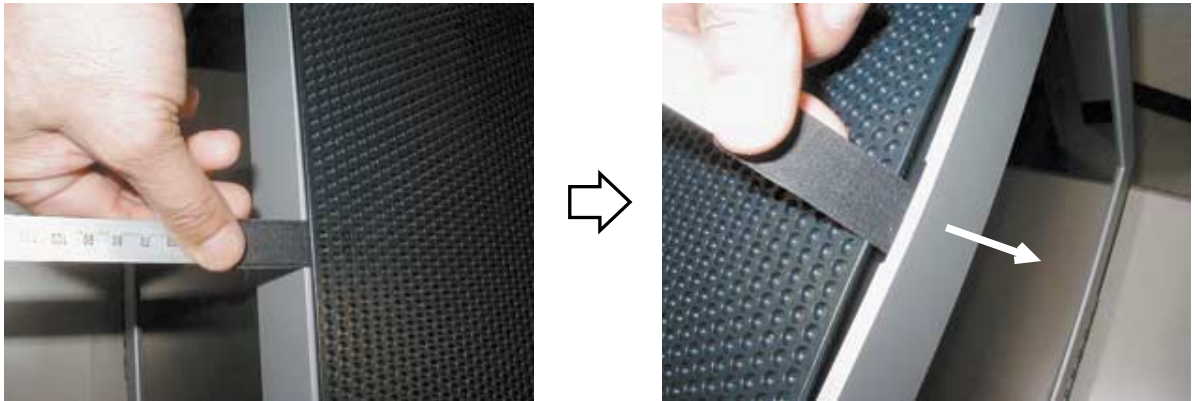

(2) The insertion pin of the four upper parts and two double-sided tapes are removed pulling the upper part of Bezel slowly.

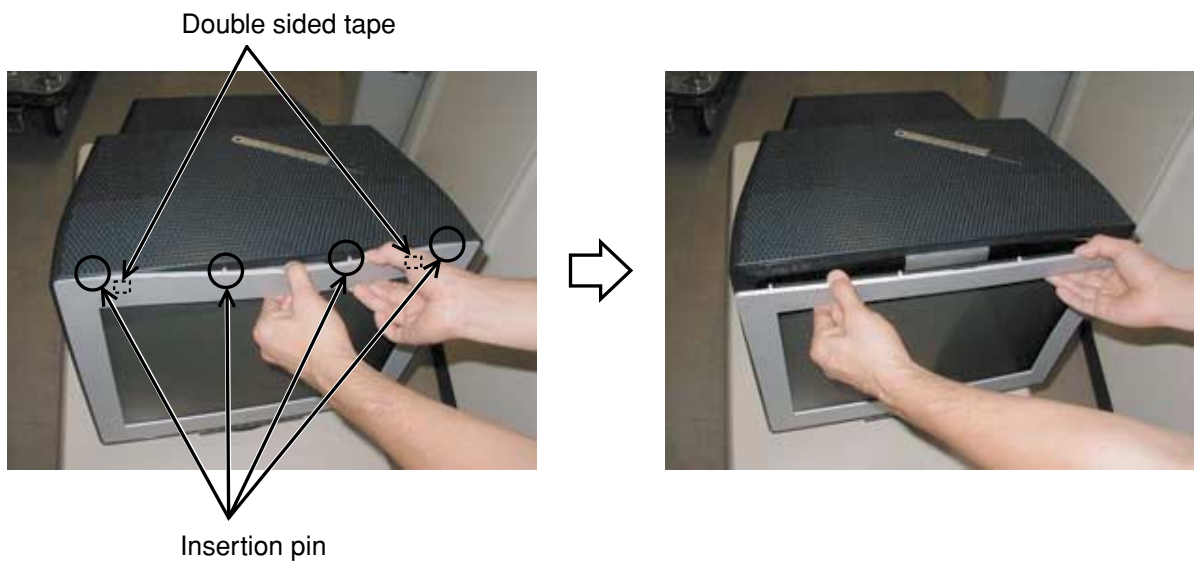

(3) Two insertion pin right and left each of a side part, and lower four insertion pins and two hooks are also pulled slowly, and removed Bezel.

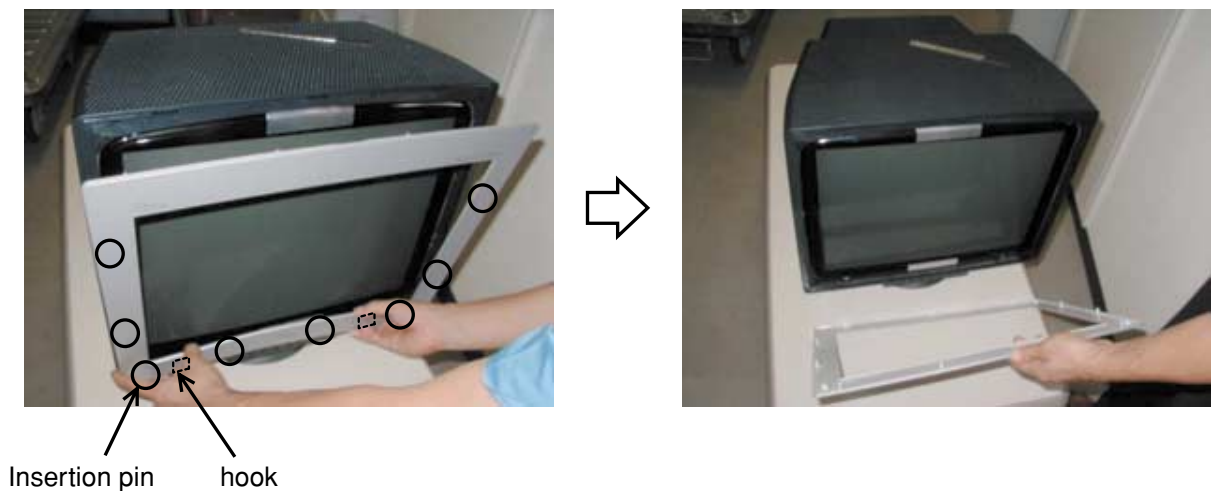

## 4. Removal Instruction for Back Cover

- (1) The screws of the two places of the lower parts of the Back Cover are removed.
- (2) Two hooks of the front lower part of Back Cover is pressed down, and the lower part of Back Cover is removed.

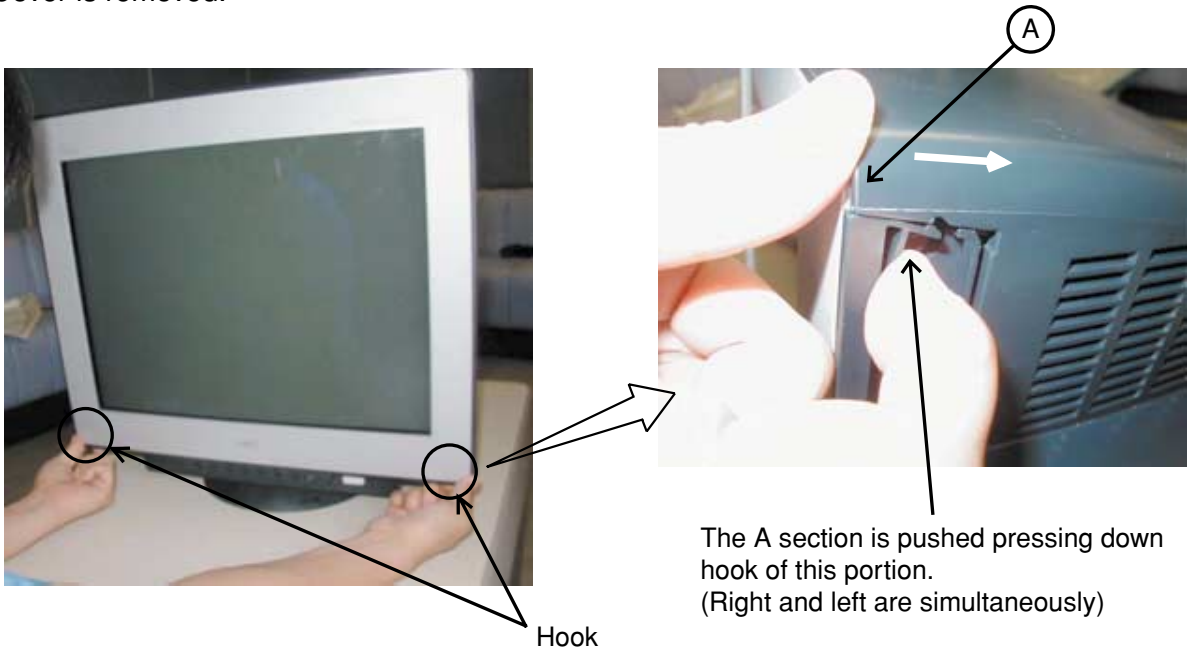

- (3) Hooks are removed by considering the penetration hole (three places) of the front upper part of Back Cover as a mark, inserting a jig from the direction of an end. and pushing in a jig downward.

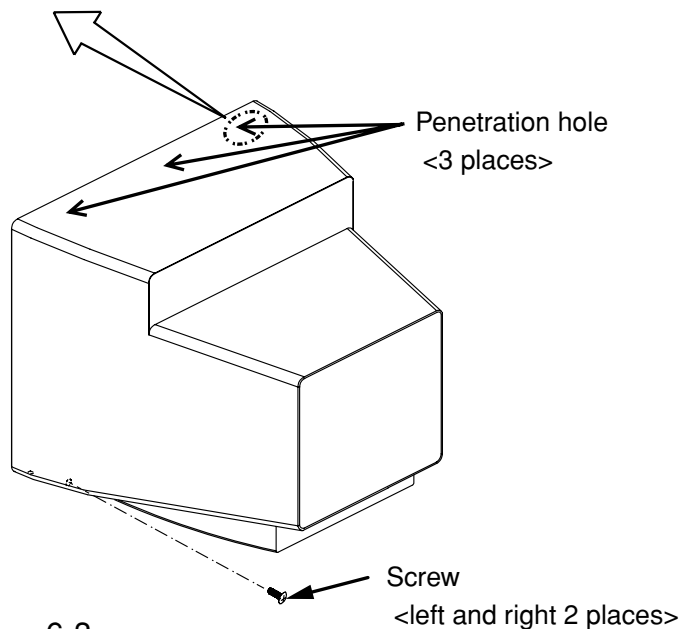
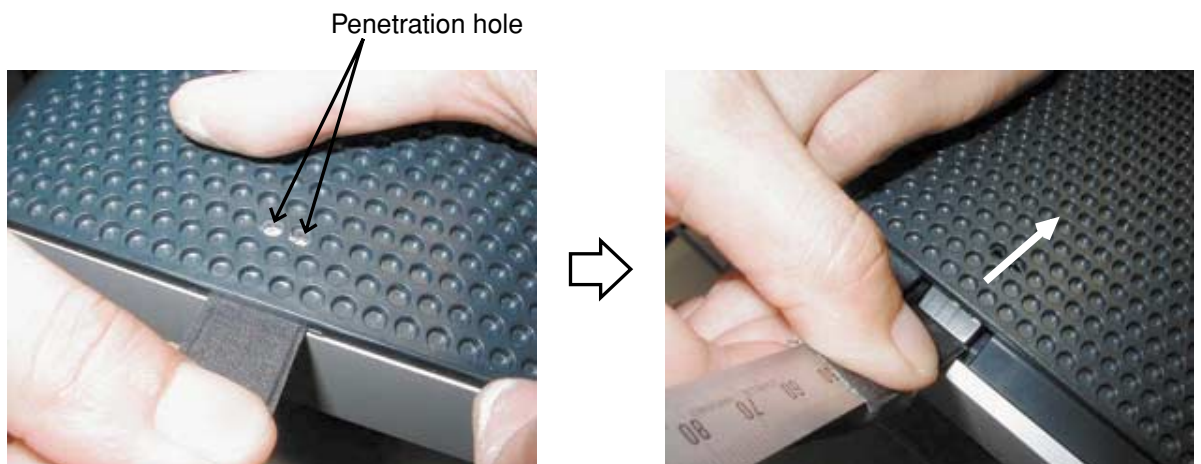

(4) If one hook part place of an end is removed, the others are depressed with a jig to remove hooks simultaneously and also Back Cover is pulled back to remove.

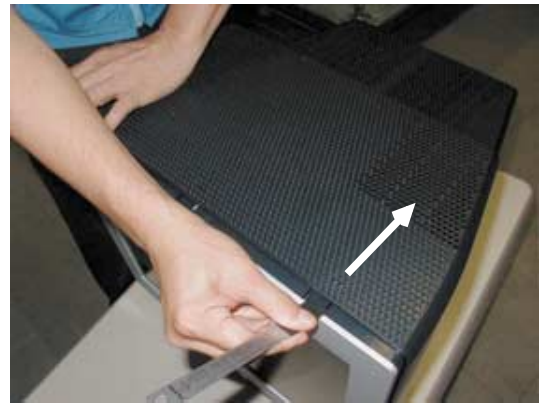

# SERIAL NUMBER INFORMATION

Refer to the serial number information shown below.

Ex.) Rating label

Model name: Diamond Pro 2070SB / Diamond Pro 2070SB-BK  
Model NO.: C22BW711

Serial No.	Manufactured
*****	

→ 2 0 1 0 0 0 0 0 1

Manufactured Year: 0 to 9  
(Last digit)

Manufactured Month: 01 to 12

Control Code: 0 to 9 or A to Z  
(It is possible to use fixed no. for same destination  
if model name is same.)

Running No.: 00001 to 99999

## ALL PARTS LIST

MODEL: Diamond Pro 2070SB-BK(R)

LOCATION	PART No.	DESCRIPTION/SPECIFICATION	
<b>**CAPACITOR***</b>			
C100	79PQ0210	ELECT 85 C/T 47U/16V M	GA347625
C111	79EN0482	C ELE 85C/T 470U/10V M	GA347715
C120	79EN0482	C ELE 85C/T 470U/10V M	GA347715
C127	79EN0108	C ELE 85 /T 47U/16V M	80019871
C135	79PQ0208	ELECT 85 C/T 4.7U/50V M	GA347555
C153	79EN0479	C ELE 85C/T 10U/25V M	GA310635
C154	79EN0479	C ELE 85C/T 10U/25V M	GA310635
C155	79PQ0210	ELECT 85 C/T 47U/16V M	GA347625
C1A1	79PQ5240	C SMD X7R 0.1U 16V K 0603	GX410423
C1A2	79PQ5355	C SMD X7R 0.01U 50V K 060	GX410353
C1A4	79PQ5492	C SMD C0G 68P 50V J 0603	GX468052
C1A5	79PQ5492	C SMD C0G 68P 50V J 0603	GX468052
C1A6	79PQ5492	C SMD C0G 68P 50V J 0603	GX468052
C1A7	79PQ5492	C SMD C0G 68P 50V J 0603	GX468052
C1A8	79PQ5492	C SMD C0G 68P 50V J 0603	GX468052
C1A9	79PQ5492	C SMD C0G 68P 50V J 0603	GX468052
C1B1	79PQ5488	C SMD C0G 30P 50V J 0603	GX430052
C1B2	79PQ5240	C SMD X7R 0.1U 16V K 0603	GX410423
C1B6	79PQ5480	C SMD X7R 0.47U 25V K 080	GX047433
C1B7	79PQ5355	C SMD X7R 0.01U 50V K 060	GX410353
C1C3	79PQ5480	C SMD X7R 0.47U 25V K 080	GX047433
C1C7	79PQ5480	C SMD X7R 0.47U 25V K 080	GX047433
C1C9	79PQ5240	C SMD X7R 0.1U 16V K 0603	GX410423
C1D0	79PQ5240	C SMD X7R 0.1U 16V K 0603	GX410423
C1D1	79PQ5240	C SMD X7R 0.1U 16V K 0603	GX410423
C1D3	79PQ5484	C SMD C0G 18P 50V J 0603	GX418052
C1D4	79PQ5484	C SMD C0G 18P 50V J 0603	GX418052
C1D5	79PQ5492	C SMD C0G 68P 50V J 0603	GX468052
C1D6	79PQ5492	C SMD C0G 68P 50V J 0603	GX468052
C1E0	79PQ5492	C SMD C0G 68P 50V J 0603	GX468052
C1E1	79PQ5492	C SMD C0G 68P 50V J 0603	GX468052
C1E5	79PQ5480	C SMD X7R 0.47U 25V K 080	GX047433
C1E6	79PQ5240	C SMD X7R 0.1U 16V K 0603	GX410423
C1E7	79PQ5492	C SMD C0G 68P 50V J 0603	GX468052
C1E8	79PQ5509	C SMD C0G 30P 50V J 0603	GX430052
C1E9	79PQ5240	C SMD X7R 0.1U 16V K 0603	GX410423
C203H	79PQ0242	CC Z5V(F)/T 0.01U/50V Z	GB910358
C205S	79PQ1090	CERAMIC 1000P/2KV	GB7102J3
C210B	79PQ1586	MEF CAP BOX 0.1U/250V J	GF210482
C210G	79PQ1586	MEF CAP BOX 0.1U/250V J	GF210482
C210R	79PQ1586	MEF CAP BOX 0.1U/250V J	GF210482
C212B	79PQ5594	C SMD C0G 10P 100V J 0805	GX010072
C212G	79PQ5594	C SMD C0G 10P 100V J 0805	GX010072
C212R	79PQ5594	C SMD C0G 10P 100V J 0805	GX010072
C215B	79PQ5592	CAP CERAMIC Y5P(B)/T 1800	GB718253
C215G	79PQ5592	CAP CERAMIC Y5P(B)/T 1800	GB718253
C215R	79PQ5592	CAP CERAMIC Y5P(B)/T 1800	GB718253
C220B	79PQ5596	C SMD Y5V 1U 10V Z 0603	GX410518
C220G	79PQ5596	C SMD Y5V 1U 10V Z 0603	GX410518
C220R	79PQ5596	C SMD Y5V 1U 10V Z 0603	GX410518
C221B	79PQ5590	CAP ELECT NP/T 47U/16V M	GA447625
C221G	79PQ5589	CAP ELECT NP/T 100U/16V M	GA410725
C221R	79PQ5590	CAP ELECT NP/T 47U/16V M	GA447625
C222B	79PQ5554	C SMD X7R 0.01U 50V K 060	GX410353
C222G	79PQ5554	C SMD X7R 0.01U 50V K 060	GX410353
C222R	79PQ5554	C SMD X7R 0.01U 50V K 060	GX410353
C240B	79PQ5590	CAP ELECT NP/T 47U/16V M	GA447625
C240G	79PQ5589	CAP ELECT NP/T 100U/16V M	GA410725
C240R	79PQ5590	CAP ELECT NP/T 47U/16V M	GA447625
C250B	79PQ1586	MEF CAP BOX 0.1U/250V J	GF210482
C250G	79PQ1586	MEF CAP BOX 0.1U/250V J	GF210482
C250R	79PQ1586	MEF CAP BOX 0.1U/250V J	GF210482
C251B	79PQ5554	C SMD X7R 0.01U 50V K 060	GX410353
C251G	79PQ5554	C SMD X7R 0.01U 50V K 060	GX410353
C251R	79PQ5554	C SMD X7R 0.01U 50V K 060	GX410353
C260	79PQ5585	CAP ELECT 105OC/T 3.3U/25	GA233585
C261	79PQ5554	C SMD X7R 0.01U 50V K 060	GX410353
C262	79PQ0199	ELECT 85 C/T 100U/16V M	GA310725
C264	79PQ5590	CAP ELECT NP/T 47U/16V M	GA447625
C265	79PQ5554	C SMD X7R 0.01U 50V K 060	GX410353
C266	79PQ5554	C SMD X7R 0.01U 50V K 060	GX410353
C271	79PQ5554	C SMD X7R 0.01U 50V K 060	GX410353
C274	79PQ5554	C SMD X7R 0.01U 50V K 060	GX410353

ALL PARTS LIST

MODEL: Diamond Pro 2070SB-BK(R)

LOCATION	PART No.	DESCRIPTION/SPECIFICATION	
C275	79PQ0210	ELECT 85 C/T 47U/16V M	GA347625
C276	79PQ0373	ELECT 85C/T 10U/16V M	GA310625
C281	79PQ5586	CAP ELECT 105OC/T 47U/100	GA247675
C282	79PQ5554	C SMD X7R 0.01U 50V K 060	GX410353
C283	79PQ5591	CAP CERAMIC Y5P(B)/T 0.01	GB7103F3
C284	79PQ5554	C SMD X7R 0.01U 50V K 060	GX410353
C285	79PQ0210	ELECT 85 C/T 47U/16V M	GA347625
C286	79PQ5554	C SMD X7R 0.01U 50V K 060	GX410353
C287	79PQ5554	C SMD X7R 0.01U 50V K 060	GX410353
C289	79PQ5554	C SMD X7R 0.01U 50V K 060	GX410353
C290	79PQ5588	CAP ELECT 85OC/T 470U/10V	GA347715
C291	79PQ0210	ELECT 85 C/T 47U/16V M	GA347625
C292	79PQ5593	CAP PLASTIC MEF BOX/T 0.1	GF210462
C294	79PQ5588	CAP ELECT 85OC/T 470U/10V	GA347715
C295	79PQ5554	C SMD X7R 0.01U 50V K 060	GX410353
C296	79PQ5554	C SMD X7R 0.01U 50V K 060	GX410353
C297	79PQ5554	C SMD X7R 0.01U 50V K 060	GX410353
C299	79PQ5588	CAP ELECT 85OC/T 470U/10V	GA347715
C2C0	79PQ5554	C SMD X7R 0.01U 50V K 060	GX410353
C2C1	79PQ0210	ELECT 85 C/T 47U/16V M	GA347625
C2D0	79PQ0204	ELECT 85 C/T 220U/16V M	GA322725
C2D1	79PQ5555	C SMD X7R 0.1U 16V K 0603	GX410423
C2D2	79PQ0252	MEF CAP BOX 0.01U/63V J	GF210362
C2D3	79PQ5552	C SMD C0G 100P 50V J 0603	GX410152
C2D4	79PQ5550	C SMD X7R 0.01U 50V K 080	GX010353
C2D5	79PQ0210	ELECT 85 C/T 47U/16V M	GA347625
C2D6	79PQ5555	C SMD X7R 0.1U 16V K 0603	GX410423
C2D7	79PQ5552	C SMD C0G 100P 50V J 0603	GX410152
C2E0	79PQ5555	C SMD X7R 0.1U 16V K 0603	GX410423
C2E1	79PQ5552	C SMD C0G 100P 50V J 0603	GX410152
C2P0	79PQ5554	C SMD X7R 0.01U 50V K 060	GX410353
C2P1	79PQ5550	C SMD X7R 0.01U 50V K 080	GX010353
C2P2	79PQ5554	C SMD X7R 0.01U 50V K 060	GX410353
C2P4	79PQ5554	C SMD X7R 0.01U 50V K 060	GX410353
C2P6	79PQ0234	CC Y5P(B)/T 1000P/500V K	GB7102F3
C2P8	79PQ0234	CC Y5P(B)/T 1000P/500V K	GB7102F3
C2S1	79PQ0199	ELECT 85 C/T 100U/16V M	GA310725
C2S2	79PQ5554	C SMD X7R 0.01U 50V K 060	GX410353
C2S3	79PQ5552	C SMD C0G 100P 50V J 0603	GX410152
C2S4	79PQ5552	C SMD C0G 100P 50V J 0603	GX410152
C2W0	79PQ5552	C SMD C0G 100P 50V J 0603	GX410152
C2W1	79PQ5552	C SMD C0G 100P 50V J 0603	GX410152
C401	79PQ0223	ELECT 105 C/A1000U/25V M	GAB10835
C402	79PQ0223	ELECT 105 C/A1000U/25V M	GAB10835
C403	79PQ0238	CC Y5P(B)/T 470P/50V K	GB747153
C404	79EN0472	C ELE 105C/T 100U/50V M	GA210755
C405	79PQ0757	MEF CAP BOX 0.22U/100V J	GF222472
C406	79PQ0238	CC Y5P(B)/T 470P/50V K	GB747153
C407	79PQ2238	MEF CAP BOX 0.0015U/50V J	GF215252
C410	79EN0490	C PLA MEF 0.047U/100V J	GF247372
C503	79PQ0253	MEF CAP BOX 0.1U/63V J	GF210462
C505	79PQ1717	CERAMIC Y5P(B) 2200P/500V	GB7222F3
C507	79EN0485	C ELE 105C/A 470U/35V M	GAB47745
C550	79EN0118	C FIL FLSA(445)1.8KV 332H	80019131
C560	79EN0488	C CER Y5P B/T 680P/500V K	GB7681F3
C561	79PQ0854	CC Y5P(B)/T 470P/500V K	GB7471F3
C564	79EN0110	C FIL FHSM(165) 250V 135J	80019041
C565	79EN0111	C FIL FHSM(165) 250V 154J	80019051
C566	79EN0115	C FIL FHSM(165) 250V 563J	80019101
C567	79EN0114	C FIL FHSM(165) 250V 474J	80019091
C568	79EN0112	C FIL FHSM(165) 250V 244J	80019071
C575	79EN0117	C FIL FHSM(165) 250V 824J	80019121
C576	79EN0116	C FIL FHSM(165) 250V 623J	80019111
C577	79EN0116	C FIL FHSM(165) 250V 623J	80019111
C578	79EN0113	C FIL FHSM(165) 250V 433J	80019081
C580	79EN0047	C FIL FHSM(165) 250V 243J	80019061
C590	79EN0413	C CERAMIC SL/T 100P/2KV J	80019621
C591	79EN0094	CERA Y5P(B)/T 2200P/250V	GB722283
C5A1	79EN0099	C ELE 105 /A 2200U/10V M	GAB22815
C5A2	79EN0099	C ELE 105 /A 2200U/10V M	GAB22815
C5C3	79PQ0210	ELECT 85 C/T 47U/16V M	GA347625
C5C6	79EN0750	C PLA MEF 0.82U/63V J	GF282462
C5C7	79PQ0252	MEF CAP BOX 0.01U/63V J	GF210362
C5C8	79PQ0253	MEF CAP BOX 0.1U/63V J	GF210462



ALL PARTS LIST

MODEL: Diamond Pro 2070SB-BK(R)

LOCATION	PART No.	DESCRIPTION/SPECIFICATION	
C5C9	79EN0101	C ELE 105 /T 2.2U/50V M	GA222555
C5D1	79PQ0204	ELECT 85 C/T 220U/16V M	GA322725
C5D4	79PQ1586	MEF CAP BOX 0.1U/250V J	GF210482
C5F0	79EN0105	C ELE 105C/T 47U/250V M	GA247685
C5F1	79EN0104	C ELE 105 /T 33U/250V M	GA233685
C5G0	79PQ1914	ELECT 105C/T 2.2U/250V M	GA222585
C5G1	79EN0474	C ELE 105C/T 2.2U/200V M	GA2225C5
C5G2	79EN0477	C ELE 105C/T 3.3U/200V M	GA2335C5
C600	79PQ0199	ELECT 85 C/T 100U/16V M	GA310725
C601	79PQ5508	C SMD X7R 0.1U 50V K 0805	GX010453
C602	79PQ0199	ELECT 85 C/T 100U/16V M	GA310725
C603	79PQ5473	C SMD X7R 0.018U 50V K 08	GX018353
C604	79PQ5355	C SMD X7R 0.01U 50V K 060	GX410353
C605	79PQ5472	C SMD Y5V 1U 50V Z 0805	GX010558
C606	79PQ5508	C SMD X7R 0.1U 50V K 0805	GX010453
C607	79PQ5355	C SMD X7R 0.01U 50V K 060	GX410353
C608	79PQ0199	ELECT 85 C/T 100U/16V M	GA310725
C609	79PQ5355	C SMD X7R 0.01U 50V K 060	GX410353
C610	79PQ5355	C SMD X7R 0.01U 50V K 060	GX410353
C611	79PQ5482	C SMD X7R 0.1U 25V K 0603	GX410433
C612	79PQ0851	ELECT 85C/T 470U/16VM	GA347725
C613	79PQ5482	C SMD X7R 0.1U 25V K 0603	GX410433
C614	79PQ5491	C SMD X7R 0.047U 50V K 06	GX447353
C615	79PQ5478	C SMD X7R 4700P 50V K 080	GX047253
C616	79PQ5491	C SMD X7R 0.047U 50V K 06	GX447353
C617	79PQ5508	C SMD X7R 0.1U 50V K 0805	GX010453
C618	79PQ5508	C SMD X7R 0.1U 50V K 0805	GX010453
C619	79PQ5468	C SMD C0G 1000P 50V J 080	GX010252
C620	79EN0482	C ELE 85C/T 470U/10V M	GA347715
C621	79PQ0210	ELECT 85 C/T 47U/16V M	GA347625
C622	79PQ5479	C SMD X7R 0.047U 50V K 08	GX047353
C623	79PQ0198	ELECT 85 C/T 10U/50V M	GA310655
C624	79PQ5355	C SMD X7R 0.01U 50V K 060	GX410353
C625	79EN0378	C ELE/T105 47U/25V M ZL	80015161
C626	79PQ5355	C SMD X7R 0.01U 50V K 060	GX410353
C627	79PQ5472	C SMD Y5V 1U 50V Z 0805	GX010558
C628	79EN0343	C SMD X7R/T 0.082U/25V J	80014341
C629	79PQ0198	ELECT 85 C/T 10U/50V M	GA310655
C630	79EN0106	C ELE 85 /T 330U/6.3V M	GA333705
C631	79PQ5355	C SMD X7R 0.01U 50V K 060	GX410353
C632	79PQ5508	C SMD X7R 0.1U 50V K 0805	GX010453
C633	79PQ5355	C SMD X7R 0.01U 50V K 060	GX410353
C634	79PQ5355	C SMD X7R 0.01U 50V K 060	GX410353
C635	79PQ0210	ELECT 85 C/T 47U/16V M	GA347625
C636	79EN0481	C ELE 85C/T 33U/6.3V M	GA333605
C638	79PQ5247	C SMD C0G 100P 50V J 0603	GX410152
C639	79PQ5247	C SMD C0G 100P 50V J 0603	GX410152
C6B3	79PQ1918	ELECT 105C/T 330U/16V M	GA233725
C6B4	79PQ0198	ELECT 85 C/T 10U/50V M	GA310655
C6B8	79PQ0210	ELECT 85 C/T 47U/16V M	GA347625
C700	79PQ0198	ELECT 85 C/T 10U/50V M	GA310655
C701	79EN0421	C ELE/T 105 470U 100V M	80020071
C702	79EN0109	C FILM/T PPN 2200P 800V J	80018681
C703	79EN0335	C FILM/T PPN 8200P/630V J	80014121
C704	79EN0100	C ELE 105 /T 10U/50V M	GA210655
C706	79PQ5355	C SMD X7R 0.01U 50V K 060	GX410353
C707	79PQ5475	C SMD C0G 330P 50V J 0805	GX033152
C708	79PQ5476	C SMD X7R 0.033U 50V K 08	GX033353
C709	79PQ5477	C SMD X7R 0.33U 50V K 080	GX033453
C710	79PQ5472	C SMD Y5V 1U 50V Z 0805	GX010558
C711	79PQ5355	C SMD X7R 0.01U 50V K 060	GX410353
C712	79PQ5508	C SMD X7R 0.1U 50V K 0805	GX010453
C713	79PQ5508	C SMD X7R 0.1U 50V K 0805	GX010453
C714	79PQ5508	C SMD X7R 0.1U 50V K 0805	GX010453
C715	79PQ5492	C SMD C0G 68P 50V J 0603	GX468052
C716	79PQ5508	C SMD X7R 0.1U 50V K 0805	GX010453
C717	79PQ5355	C SMD X7R 0.01U 50V K 060	GX410353
C718	79PQ5470	C SMD X7R 0.01U 50V K 080	GX010353
C719	79EN0101	C ELE 105 /T 2.2U/50V M	GA222555
C720	79PQ5508	C SMD X7R 0.1U 50V K 0805	GX010453
C721	79PQ5355	C SMD X7R 0.01U 50V K 060	GX410353
C722	79PQ5355	C SMD X7R 0.01U 50V K 060	GX410353
C723	79EN0098	C ELE /T 85 2200U 6.3V M	80017831
C724	79PQ5355	C SMD X7R 0.01U 50V K 060	GX410353



ALL PARTS LIST

MODEL: Diamond Pro 2070SB-BK(R)

LOCATION	PART No.	DESCRIPTION/SPECIFICATION	
C725	79PQ5355	C SMD X7R 0.01U 50V K 060	GX410353
C726	79PQ1564	ELECT 105O C/T 1U/50V M	GA210555
C727	79PQ5355	C SMD X7R 0.01U 50V K 060	GX410353
C728	79PQ5355	C SMD X7R 0.01U 50V K 060	GX410353
C729	79PQ5507	RES MOF 3W/M(A) 5% 68OHM	FB710680
C730	79EN0100	C ELE 105 /T 10U/50V M	GA210655
C731	79PQ1083	ELECT NP/T 10U/50V M	GA410655
C732	79PQ0198	ELECT 85 C/T 10U/50V M	GA310655
C7A1	79EN0097	C ELE /T 105 2.2U 450V M	80017771
C7A2	79EN0487	C CERAMIC 330P/500V K	GB7331F3
C7B1	79PQ1080	ELECT 105 C/T 47U/100V M	GA247675
C7B2	79PQ0761	MEF CAP BOX 0.33U/100V J	GF233472
C801	79PQ5355	C SMD X7R 0.01U 50V K 060	GX410353
C805	79EN0475	C ELE 105C/T 220U/25V M	GA222735
C806	79EN0475	C ELE 105C/T 220U/25V M	GA222735
C807	79PQ5508	C SMD X7R 0.1U 50V K 0805	GX010453
C811	79PQ5508	C SMD X7R 0.1U 50V K 0805	GX010453
C812	79PQ5241	C SMD X7R 4700P 50V K 060	GX447253
C813	79PQ5355	C SMD X7R 0.01U 50V K 060	GX410353
C814	79PQ5355	C SMD X7R 0.01U 50V K 060	GX410353
C815	79PQ5508	C SMD X7R 0.1U 50V K 0805	GX010453
C816	79PQ5490	C SMD C0G 470P 50V J 0603	GX447152
C817	79PQ5241	C SMD X7R 4700P 50V K 060	GX447253
C818	79PQ5241	C SMD X7R 4700P 50V K 060	GX447253
C819	79PQ5241	C SMD X7R 4700P 50V K 060	GX447253
C820	79PQ5490	C SMD C0G 470P 50V J 0603	GX447152
C821	79PQ5508	C SMD X7R 0.1U 50V K 0805	GX010453
C827	79PQ5508	C SMD X7R 0.1U 50V K 0805	GX010453
C828	79PQ5241	C SMD X7R 4700P 50V K 060	GX447253
C829	79PQ5241	C SMD X7R 4700P 50V K 060	GX447253
C830	79PQ5241	C SMD X7R 4700P 50V K 060	GX447253
C831	79PQ5355	C SMD X7R 0.01U 50V K 060	GX410353
C832	79PQ5355	C SMD X7R 0.01U 50V K 060	GX410353
C834	79PQ5490	C SMD C0G 470P 50V J 0603	GX447152
C835	79PQ5241	C SMD X7R 4700P 50V K 060	GX447253
C838	79PQ5490	C SMD C0G 470P 50V J 0603	GX447152
C840	79PQ5241	C SMD X7R 4700P 50V K 060	GX447253
C841	79PQ5355	C SMD X7R 0.01U 50V K 060	GX410353
C842	79PQ5355	C SMD X7R 0.01U 50V K 060	GX410353
C843	79PQ5490	C SMD C0G 470P 50V J 0603	GX447152
C844	79PQ5241	C SMD X7R 4700P 50V K 060	GX447253
C845	79PQ5241	C SMD X7R 4700P 50V K 060	GX447253
C848	79PQ5355	C SMD X7R 0.01U 50V K 060	GX410353
C849	79PQ5355	C SMD X7R 0.01U 50V K 060	GX410353
C8A1	79PQ5485	C SMD C0G 22P 50V J 0603	GX422052
C8A2	79PQ5483	C SMD C0G 150P 50V J 060	GX415152
C8A3	79PQ5489	C SMD C0G 33P 50V J 0603	GX433052
C8A4	79PQ5489	C SMD C0G 33P 50V J 0603	GX433052
C8A5	79EN0747	C ELE /T 105C/220U 25V M	80017801
C8A6	79EN0747	C ELE /T 105C/220U 25V M	80017801
C8A8	79PQ5485	C SMD C0G 22P 50V J 0603	GX422052
C8A9	79PQ5483	C SMD C0G 150P 50V J 060	GX415152
C8P0	79PQ1921	ELECT 105C/T 470U/25V M	GA247735
C8P01	79PQ5587	CAP ELECT 105OC/T 470U/25	GA247735
C8P1	79PQ1921	ELECT 105C/T 470U/25V M	GA247735
C8P12	79PQ5587	CAP ELECT 105OC/T 470U/25	GA247735
C8P2	79PQ5587	CAP ELECT 105OC/T 470U/25	GA247735
C8P3	79PQ5598	C SMD X7R 4700P 50V K 060	GX447253
C8P4	79PQ5598	C SMD X7R 4700P 50V K 060	GX447253
C8P5	79PQ5597	C SMD C0G 470P 50V J 0603	GX447152
C8P6	79PQ5595	C SMD X7R 0.1U 25V K 0603	GX410433
C8P7	79PQ5554	C SMD X7R 0.01U 50V K 060	GX410353
C8Q1	79PQ5466	CAP ELECT 105OC/T 10U/25V	GA210635
C8Q2	79PQ5241	C SMD X7R 4700P 50V K 060	GX447253
C8Q3	79PQ5241	C SMD X7R 4700P 50V K 060	GX447253
C8Q4	79PQ3034	C SMD X7R 1000P 50V K 060	GX410253
C8Q5	79PQ3034	C SMD X7R 1000P 50V K 060	GX410253
C8Q6	79PQ5241	C SMD X7R 4700P 50V K 060	GX447253
C8Q7	79PQ5241	C SMD X7R 4700P 50V K 060	GX447253
C8Q8	79PQ5241	C SMD X7R 4700P 50V K 060	GX447253
C8Q9	79PQ5505	C SMD X7R 220P 50V K 0805	GX022153
C8R0	79PQ5241	C SMD X7R 4700P 50V K 060	GX447253
C8R1	79PQ5241	C SMD X7R 4700P 50V K 060	GX447253
C8R2	79PQ5483	C SMD C0G 150P 50V J 060	GX415152

## ALL PARTS LIST

MODEL: Diamond Pro 2070SB-BK(R)

LOCATION	PART No.	DESCRIPTION/SPECIFICATION	
C8R3	79PQ5485	C SMD C0G 22P 50V J 0603	GX422052
C8R4	79PQ2703	MEF CAP BOX 1U/50V J	GF210552
C8R5	79PQ3034	C SMD X7R 1000P 50V K 060	GX410253
C8R6	79PQ3034	C SMD X7R 1000P 50V K 060	GX410253
C901	79EN0751	C SAFE X-CAP 1U/AC275V M	GJ010509
C902	79EN0752	C SAFE Y-CAP/D 2200P 400V	80018881
C903	79EN0752	C SAFE Y-CAP/D 2200P 400V	80018881
C906	79EN0334	C PLASTIC MEF 1U/450V K	80014091
C907	79PQ0253	MEF CAP BOX 0.1U/63V J	GF210462
C908	79PQ1194	MEF CAP BOX 0.68U 50V J	GF268452
C909	79PQ5534	C SMD X7R 0.01U 50V K 060	GX410353
C910	79PQ5535	C SMD X7R 470P 50V K 0603	GX447153
C911	79EN0095	C ELE /A 85 220U 450V M	80019661
C912	79EN0055	FILM MEF BOX/T 0.033U 630	80019471
C914	79EN0332	C CERAMIC SL/T 220P/2KV J	80013921
C915	79EN0478	C ELE 105C/T 47U/35V M	GA247645
C916	79EN0783	C SMD NPO/T 1000P/25V J	GX410232
C917	79PQ5535	C SMD X7R 470P 50V K 0603	GX447153
C918	79PQ5534	C SMD X7R 0.01U 50V K 060	GX410353
C919	79PQ5534	C SMD X7R 0.01U 50V K 060	GX410353
C920	79PQ5536	C SMD X7R 0.047U 25V K 06	GX447333
C921	79PQ5534	C SMD X7R 0.01U 50V K 060	GX410353
C930	79PQ1079	ELECT 105 C/T 47U/16V M	GA247625
C931	79PQ1913	ELECT 105C/T 100U/35V M	GA210745
C932	79PQ0252	MEF CAP BOX 0.01U/63V J	GF210362
C935	79EN0478	C ELE 105C/T 47U/35V M	GA247645
C938	79PQ5536	C SMD X7R 0.047U 25V K 06	GX447333
C939	79EN0055	FILM MEF BOX/T 0.033U 630	80019471
C961	79EN0336	C ELE/T 105 100U 250V M	80014151
C962	79EN0104	C ELE 105 /T 33U/250V M	GA233685
C963	79EN0340	C ELE/T 105 82U 100V M ZL	80014241
C964	79EN0339	C ELE/T 105 820U 25V M	80014231
C965	79EN0339	C ELE/T 105 820U 25V M	80014231
C966	79PQ0252	MEF CAP BOX 0.01U/63V J	GF210362
C967	79EN0337	C ELE/T 105 22U 100V M	80014181
C968	79EN0096	C ELE /T 105 100U 16V M	80020021
C969	79EN0417	C ELE/T 105 120U 16V M ZL	80020031
C971	79EN0414	C ELE/T 105 2200U 10V MZL	80019841
C972	79EN0722	C ELE/T 105C/220U 16V M	80020041
C973	79EN0489	C PLASTIC MEF 0.39U/50V J	GF239452
C980	79EN0722	C ELE/T 105C/220U 16V M	80020041
C9A0	79EN0746	C ELE /T 105C/150U 35V M	80017761
C9A1	79EN0746	C ELE /T 105C/150U 35V M	80017761
C9A2	79PQ0234	CC Y5P(B)/T 1000P/500V K	GB7102F3
C9A3	79PQ0234	CC Y5P(B)/T 1000P/500V K	GB7102F3
<b>***DIODE***</b>			
D101	79EN0381	DIODE SMD 1SS355TE-17	80015251
D102	79EN0381	DIODE SMD 1SS355TE-17	80015251
D110	79PQ1755	ROHM DIODE 1SS244	80004711
D210B	79PQ1755	ROHM DIODE 1SS244	80004711
D210G	79PQ1755	ROHM DIODE 1SS244	80004711
D210R	79PQ1755	ROHM DIODE 1SS244	80004711
D211B	79PQ1755	ROHM DIODE 1SS244	80004711
D211G	79PQ1755	ROHM DIODE 1SS244	80004711
D211R	79PQ1755	ROHM DIODE 1SS244	80004711
D250B	79PQ1755	ROHM DIODE 1SS244	80004711
D250G	79PQ1755	ROHM DIODE 1SS244	80004711
D250R	79PQ1755	ROHM DIODE 1SS244	80004711
D251B	79PQ1755	ROHM DIODE 1SS244	80004711
D251G	79PQ1755	ROHM DIODE 1SS244	80004711
D251R	79PQ1755	ROHM DIODE 1SS244	80004711
D261	79PQ0065	DIODE T" 1N4148"	EJ044148
D262	79PQ0065	DIODE T" 1N4148"	EJ044148
D263	79PQ0065	DIODE T" 1N4148"	EJ044148
D264	79PQ0065	DIODE T" 1N4148"	EJ044148
D265	79PQ0065	DIODE T" 1N4148"	EJ044148
D270	79PQ5562	DIODE RB441Q	80009701
D2C0	79PQ0065	DIODE T" 1N4148"	EJ044148
D2C1	79PQ0065	DIODE T" 1N4148"	EJ044148
D2C6	79PQ0065	DIODE T" 1N4148"	EJ044148
D401	79PQ1782	DIODE/T 1N4005	80009721
D501	79PQ0065	DIODE T" 1N4148"	EJ044148
D502	79EN0359	DIODE/A 5A/60V SB560L	80014701
D550	79EN0052	DIODE/A 5A/1700V 5VUZ52	80019301

ALL PARTS LIST

MODEL: Diamond Pro 2070SB-BK(R)

LOCATION	PART No.	DESCRIPTION/SPECIFICATION	
D560	79EN0353	DIODE/T 1A/400V RGP10G	80014611
D5A1	79EN0355	DIODE/T 1A/200V EGP10D	80014641
D5A2	79EN0355	DIODE/T 1A/200V EGP10D	80014641
D5C0	79EN0362	DIODE/T 0.6A/200V UG06D	80014751
D5C1	79PQ0065	DIODE T" 1N4148"	EJ044148
D5C3	79PQ1755	ROHM DIODE 1SS244	80004711
D5C4	79EN0381	DIODE SMD 1SS355TE-17	80015251
D5C5	79PQ0065	DIODE T" 1N4148"	EJ044148
D5C7	79PQ0065	DIODE T" 1N4148"	EJ044148
D5F0	79PQ1782	DIODE/T 1N4005	80009721
D5F2	79EN0419	DI /A 1.5A600V S2L60 BULK	80020051
D5G0	79PQ1782	DIODE/T 1N4005	80009721
D5G1	79PQ1782	DIODE/T 1N4005	80009721
D600	79EN0381	DIODE SMD 1SS355TE-17	80015251
D601	79EN0381	DIODE SMD 1SS355TE-17	80015251
D6A3	79EN0381	DIODE SMD 1SS355TE-17	80015251
D701	79PQ1787	DIODE/A UF5408	80009771
D702	79EN0356	DIODE/T 1A/400V UF4004	80014651
D703	79EN0356	DIODE/T 1A/400V UF4004	80014651
D704	79EN0360	DIODE CB903-4SV1	80014711
D706	79EN0381	DIODE SMD 1SS355TE-17	80015251
D709	79EN0011	DIODE/T 1A/200V ERA15-02	80014691
D710	79EN0381	DIODE SMD 1SS355TE-17	80015251
D713	79PQ0065	DIODE T" 1N4148"	EJ044148
D716	79PQ0065	DIODE T" 1N4148"	EJ044148
D7A1	79EN0358	DIODE/A 1A/600V UF4005	80014671
D7B1	79PQ0065	DIODE T" 1N4148"	EJ044148
D7B2	79PQ0065	DIODE T" 1N4148"	EJ044148
D8Q0	79EN0381	DIODE SMD 1SS355TE-17	80015251
D8Q1	79EN0381	DIODE SMD 1SS355TE-17	80015251
D901	79EN0130	DI/A GBU6JL BU04	80019801
D902	79EN0086	DIODE /A 5A/600V FSF05A60	80018851
D904	79EN0357	DIODE/T 1A/1KV UF4007	80014661
D905	79PQ1755	ROHM DIODE 1SS244	80004711
D907	79PQ0065	DIODE T" 1N4148"	EJ044148
D908	79PQ0065	DIODE T" 1N4148"	EJ044148
D909	79PQ0065	DIODE T" 1N4148"	EJ044148
D911	79PQ0065	DIODE T" 1N4148"	EJ044148
D912	79PQ1755	ROHM DIODE 1SS244	80004711
D930	79EN0357	DIODE/T 1A/1KV UF4007	80014661
D932	79EN0362	DIODE/T 0.6A/200V UG06D	80014751
D933	79EN0361	DIODE/T 1.2A/600V RM10A	80014741
D934	79PQ0065	DIODE T" 1N4148"	EJ044148
D950	79PQ0065	DIODE T" 1N4148"	EJ044148
D961	79EN0127	DI /A 2A/1KV RG4C 015-304	80019811
D963	79EN0128	DI /A 3A/400V RG4 015-304	80019821
D964	79EN0129	DI /A 5A/60V FSQ05A06	80018861
D965	79EN0129	DI /A 5A/60V FSQ05A06	80018861
D966	79PQ0065	DIODE T" 1N4148"	EJ044148
D967	79EN0090	DIODE /T 1A-40V SB140/23	80017961
D968	79PQ0065	DIODE T" 1N4148"	EJ044148
D969	79PQ0065	DIODE T" 1N4148"	EJ044148
D970	79PQ0065	DIODE T" 1N4148"	EJ044148
D971	79EN0723	DIODE/A 10A/60V FMB-26L	80019831
D973	79PQ0065	DIODE T" 1N4148"	EJ044148
D976	79EN0090	DIODE /T 1A-40V SB140/23	80017961
D979	79EN0390	DIODE/T 1A/200V RGP10D/23	80017951
D980	79PQ0065	DIODE T" 1N4148"	EJ044148
MD220B	79EN0394	D SMD 0.1A80V DUAL KDS226	80018231
MD220G	79EN0394	D SMD 0.1A80V DUAL KDS226	80018231
MD220R	79EN0394	D SMD 0.1A80V DUAL KDS226	80018231
MD240B	79EN0394	D SMD 0.1A80V DUAL KDS226	80018231
MD240G	79EN0394	D SMD 0.1A80V DUAL KDS226	80018231
MD240R	79EN0394	D SMD 0.1A80V DUAL KDS226	80018231
MD717	79EN0056	DIODE SMD 0.2A/30V BAT54C	80019521
ZD100	79PQ2477	ZEN DIODE 1/2W(T) HZS6A2	EKA00601
ZD102	79EN0404	ZD SMD UDZS TE17 5.6B	80018921
ZD103	79PQ2477	ZEN DIODE 1/2W(T) HZS6A2	EKA00601
ZD104	79EN0404	ZD SMD UDZS TE17 5.6B	80018921
ZD105	79EN0404	ZD SMD UDZS TE17 5.6B	80018921
ZD106	79PQ2477	ZEN DIODE 1/2W(T) HZS6A2	EKA00601
ZD107	79PQ2477	ZEN DIODE 1/2W(T) HZS6A2	EKA00601
ZD108	79PQ2477	ZEN DIODE 1/2W(T) HZS6A2	EKA00601
ZD1A0	79EN0404	ZD SMD UDZS TE17 5.6B	80018921

ALL PARTS LIST

MODEL: Diamond Pro 2070SB-BK(R)

LOCATION	PART No.	DESCRIPTION/SPECIFICATION	
ZD1A1	79EN0404	ZD SMD UDZS TE17 5.6B	80018921
ZD1A2	79EN0404	ZD SMD UDZS TE17 5.6B	80018921
ZD1A5	79EN0404	ZD SMD UDZS TE17 5.6B	80018921
ZD1A8	79EN0404	ZD SMD UDZS TE17 5.6B	80018921
ZD1B1	79EN0404	ZD SMD UDZS TE17 5.6B	80018921
ZD1C2	79EN0404	ZD SMD UDZS TE17 5.6B	80018921
ZD2C2	79EN0404	ZD SMD UDZS TE17 5.6B	80018921
ZD2C3	79EN0404	ZD SMD UDZS TE17 5.6B	80018921
ZD2C4	79EN0404	ZD SMD UDZS TE17 5.6B	80018921
ZD2C5	79EN0404	ZD SMD UDZS TE17 5.6B	80018921
ZD2H0	79EN0032	ZENER-DIODE SMD KDZ5.6V	80018331
ZD2H5	79EN0032	ZENER-DIODE SMD KDZ5.6V	80018331
ZD2V0	79EN0032	ZENER-DIODE SMD KDZ5.6V	80018331
ZD2V5	79EN0032	ZENER-DIODE SMD KDZ5.6V	80018331
ZD402	79PQ1816	ZEN DIODE 1/2W(T) HZ5C1	EKA00506
ZD5F1	79EN0424	ZD 1/2W(T) HZ11A1	EKA00110
ZD6A2	79EN0425	ZD 1/2W(T) HZ5B3	EKA00505
ZD701	79EN0064	ZEN-DIODE SMD KDZ12V	80019761
ZD702	79EN0064	ZEN-DIODE SMD KDZ12V	80019761
ZD705	79EN0071	ZEN DIODE 1/2W(T) HZ11B2	EKA01104
ZD707	79PQ1816	ZEN DIODE 1/2W(T) HZ5C1	EKA00506
ZD708	79PQ1816	ZEN DIODE 1/2W(T) HZ5C1	EKA00506
ZD712	79PQ2477	ZEN DIODE 1/2W(T) HZS6A2	EKA00601
ZD715	79PQ1817	ZEN DIODE 1/2W(T) HZ5C3	EKA00508
ZD8P0	79EN0032	ZENER-DIODE SMD KDZ5.6V	80018331
ZD901	79EN0426	ZD 1/2W(T) HZ24-2	EKA0240B
ZD902	79EN0426	ZD 1/2W(T) HZ24-2	EKA0240B
ZD971	79EN0069	ZEN DIODE P6KE6.8(GS)	80019931
<b>***FUSE***</b>			
F8Q1	79PQ5493	FUSE 251.125 125MA	JA050051
F901	79EN0366	FUSE 215-T5.0AH AC250V	80014871
<b>***IC***</b>			
IC100	79EN0051	IC SMD XC61CN4502MR	80019291
IC101	79EN0408	IC SMD LM324DT	80019201
IC102	79PQ5495	IC HD6432128SWA05PS	80020121
IC104	79EN0137	IC SMD 24LC32AT/SN	80018601
IC105	79EN0061	IC SMD TC7W53F	80019681
IC1A0	79EN0403	IC ISP1122ANB	80018901
IC210	79EN0045	IC LINEAR LM2412T	80018821
IC211	79EN0060	IC CXA2153S	80019641
IC212	79EN0043	IC MTV038N20-16(OSD)	80018801
IC213	79EN0395	IC SMD KIA4558F	80018241
IC215	79EN0091	IC SMD 74VHCT14ASJX	80019781
IC216	79PQ5568	IC MM1470AD	80018631
IC217	79PQ5563	IC SMD BU9882F	80018941
IC2S0	79EN0049	IC MIU-231	80019191
IC401	79PQ1761	IC LA7841	80007691
IC5C0	79EN0349	IC BA9757	80014481
IC601	79EN0383	IC SMD UPD61882BGC	80015311
IC602	79EN0720	IC SMD TA48M033F(TE16L)	80015221
IC603	79PQ1762	IC BA4558F-E2(OP-AMP)	80007761
IC6A1	79EN0388	IC SMD 74VHC14SJX	80017901
IC6A2	79EN0409	IC SMD TL084CD	80019211
IC6A3	79EN0395	IC SMD KIA4558F	80018241
IC6A4	79EN0352	IC KIA7027AP	80014571
IC701	79EN0042	IC SMD MSPCS03	80018671
IC702	79PQ1762	IC BA4558F-E2(OP-AMP)	80007761
IC703	79EN0408	IC SMD LM324DT	80019201
IC801	79EN0351	IC LA6510	80014501
IC803	79EN0351	IC LA6510	80014501
IC804	79EN0351	IC LA6510	80014501
IC8A1	79EN0365	HIC STK391-110	80014821
IC8P0	79PQ5564	IC LA6500	80019031
IC8P1	79PQ5458	IC KIA4559P	80014461
IC901	79EN0350	IC MC33262P	80014491
IC902	79EN0406	IC STR-F6676	80019021
IC903	79EN0040	IC MIP2E3	80018571
IC921	79PQ1488	IC REGULATOR TL431 817B 4	80003831
IC922	79PQ1488	IC REGULATOR TL431 817B 4	80003831
IC923	79PQ1812	IC KIA7812API(TO-220)	80010651
PC901	79EN0387	IC PHOTO COUPLER PC123Y22	80015891
PC902	79EN0387	IC PHOTO COUPLER PC123Y22	80015891
PC903	79EN0387	IC PHOTO COUPLER PC123Y22	80015891
<b>***COIL, FILTER***</b>			

## ALL PARTS LIST

MODEL: Diamond Pro 2070SB-BK(R)

LOCATION	PART No.	DESCRIPTION/SPECIFICATION	
L1A0	79EN0416	FER SMD BK2125LL121	80019911
L1A1	79EN0416	FER SMD BK2125LL121	80019911
L1A3	79EN0402	FER SMD BLM21P300SPT	80018651
L1A4	79EN0416	FER SMD BK2125LL121	80019911
L1A5	79EN0416	FER SMD BK2125LL121	80019911
L1A6	79EN0402	FER SMD BLM21P300SPT	80018651
L1A7	79EN0416	FER SMD BK2125LL121	80019911
L1A8	79EN0416	FER SMD BK2125LL121	80019911
L1A9	79EN0402	FER SMD BLM21P300SPT	80018651
L1B0	79EN0416	FER SMD BK2125LL121	80019911
L1B1	79EN0416	FER SMD BK2125LL121	80019911
L1B2	79EN0402	FER SMD BLM21P300SPT	80018651
L1B3	79EN0416	FER SMD BK2125LL121	80019911
L1B4	79EN0416	FER SMD BK2125LL121	80019911
L200B	79EN0377	BEAD FBR07UA850	80015051
L200G	79EN0377	BEAD FBR07UA850	80015051
L200R	79EN0377	BEAD FBR07UA850	80015051
L201B	79EN0377	BEAD FBR07UA850	80015051
L201G	79EN0377	BEAD FBR07UA850	80015051
L201R	79EN0377	BEAD FBR07UA850	80015051
L211B	79EN0519	PEAKING COIL/T 0.18UH K	HB012188
L211G	79EN0519	PEAKING COIL/T 0.18UH K	HB012188
L211R	79EN0519	PEAKING COIL/T 0.18UH K	HB012188
L280	79EN0085	BEAD WBRID-2.3*7.5*5.5-TF	80017551
L281	79EN0013	FER SMB-201209-N2-121L	80017521
L282	79EN0372	PEAKING COIL/T 100UH J	80014941
L283	79EN0013	FER SMB-201209-N2-121L	80017521
L2C0	79EN0013	FER SMB-201209-N2-121L	80017521
L2C1	79EN0013	FER SMB-201209-N2-121L	80017521
L2D0	79EN0013	FER SMB-201209-N2-121L	80017521
L2D1	79EN0013	FER SMB-201209-N2-121L	80017521
L2H0	79EN0013	FER SMB-201209-N2-121L	80017521
L2H5	79EN0013	FER SMB-201209-N2-121L	80017521
L2P0	79EN0013	FER SMB-201209-N2-121L	80017521
L2P1	79EN0013	FER SMB-201209-N2-121L	80017521
L2P2	79EN0085	BEAD WBRID-2.3*7.5*5.5-TF	80017551
L2P4	79EN0085	BEAD WBRID-2.3*7.5*5.5-TF	80017551
L2P6	79EN0085	BEAD WBRID-2.3*7.5*5.5-TF	80017551
L2V0	79EN0013	FER SMB-201209-N2-121L	80017521
L2V5	79EN0013	FER SMB-201209-N2-121L	80017521
L2W0	79EN0013	FER SMB-201209-N2-121L	80017521
L2W1	79EN0013	FER SMB-201209-N2-121L	80017521
L550	79EN0386	BEAD FBR07HA850	80015521
L561	79EN0125	COIL LINEARITY 77A-0001	80017701
L5A1	79EN0370	CHOKE COIL 41101(NSV)	80014921
L5G0	79EN0369	PACKING COIL/A 2200UH J	80014911
L5G2	79EN0368	PACKING COIL/A 1200UH J	80014901
L5G3	79EN0521	PACKING COIL/A 1000UH J	HB020102
L5G4	79EN0521	PACKING COIL/A 1000UH J	HB020102
L600	79EN0012	FER SMB-201209-N1-601A	80017511
L601	79EN0012	FER SMB-201209-N1-601A	80017511
L602	79EN0012	FER SMB-201209-N1-601A	80017511
L603	79EN0012	FER SMB-201209-N1-601A	80017511
L604	79EN0012	FER SMB-201209-N1-601A	80017511
L6A1	79EN0012	FER SMB-201209-N1-601A	80017511
L6A2	79EN0012	FER SMB-201209-N1-601A	80017511
L701	79PQ1960	PACKING COIL/A 3.3UH K	HB020339
L702	79PQ1960	PACKING COIL/A 3.3UH K	HB020339
L703	79EN0386	BEAD FBR07HA850	80015521
L704	79EN0386	BEAD FBR07HA850	80015521
L8A1	79PQ1957	PACKING COIL/A 100UH K	HB020101
L8A2	79PQ1957	PACKING COIL/A 100UH K	HB020101
L901	79EN0088	COIL LINE-FILTER LFZ24V12	80017711
L902	79EN0375	LINE-FILTER SN10P-601JB	80015021
L903	79EN0087	CIL CHOKE SRW35EC-T77V012	80019251
L905	79EN0376	BEAD FBR07VB850	80015041
L906	79EN0085	BEAD WBRID-2.3*7.5*5.5-TF	80017551
L960	79EN0522	PACKING COIL/A 47UH K	HB020470
L961	79EN0522	PACKING COIL/A 47UH K	HB020470
L971	79EN0522	PACKING COIL/A 47UH K	HB020470
X6A01	6A101100	L NOISE FILTER SUP-L3G-E-	CP452P253A10
X6A01	6A103005	CORE T21*20*9	CP410C024A10
X6A01	6A132205	L COIL SET 17.1OHM K	CP409B045A10

\*\*\*TRANSISTOR\*\*\*

ALL PARTS LIST

MODEL: Diamond Pro 2070SB-BK(R)

LOCATION	PART No.	DESCRIPTION/SPECIFICATION	
MQ5C1	79EN0411	TR SMD NPN RN1502	80019361
Q100	79EN0397	TR SMD PNP KRA107S	80018301
Q101	79EN0028	TR 0.1A/50V KRC110S	80018271
Q102	79EN0028	TR 0.1A/50V KRC110S	80018271
Q103	79EN0028	TR 0.1A/50V KRC110S	80018271
Q104	79PQ5457	TR SMD NPN 0.1A/50V KRC10	80019791
Q105	79EN0397	TR SMD PNP KRA107S	80018301
Q1A1	79EN0062	FET P 1.6A/20V FDN338P	80019691
Q1A2	79EN0062	FET P 1.6A/20V FDN338P	80019691
Q1A3	79EN0062	FET P 1.6A/20V FDN338P	80019691
Q1A4	79EN0062	FET P 1.6A/20V FDN338P	80019691
Q250B	79PQ0811	TR NPN BF422 TO-92(T)	EAA04220
Q250G	79PQ0811	TR NPN BF422 TO-92(T)	EAA04220
Q250R	79PQ0811	TR NPN BF422 TO-92(T)	EAA04220
Q251B	79PQ0061	TR PNP BF423 TO-92(T)	EBA04230
Q251G	79PQ0061	TR PNP BF423 TO-92(T)	EBA04230
Q251R	79PQ0061	TR PNP BF423 TO-92(T)	EBA04230
Q260	79EN0030	TR 0.15A/50V KTC3875S-GR	80018291
Q280	79PQ5567	TR SMD PNP 0.1A/50V KRA30	80018311
Q281	79PQ5566	TR SMD NPN 0.1A/50V KRC42	80019951
Q282	79EN0028	TR 0.1A/50V KRC110S	80018271
Q2P0	79PQ1685	TR PNP 2SA1020Y TO-92(T)	EBA10205
Q2P1	79EN0030	TR 0.15A/50V KTC3875S-GR	80018291
Q2P2	79EN0030	TR 0.15A/50V KTC3875S-GR	80018291
Q501	79EN0241	TR SMD N 2SK2158	80008091
Q502	79EN0030	TR 0.15A/50V KTC3875S-GR	80018291
Q503	79EN0031	TR 0.15A/50V KTA1504S-GR	80018321
Q504	79EN0053	FET N 2SK3205	80019311
Q550	79EN0054	TR NPN 2SC5570 TO-3P	80019341
Q560	79PQ2384	TR NPN KTC2026-Y/GR TO220	80009921
Q561	79EN0759	FET N IRFS630B	80017861
Q562	79EN0759	FET N IRFS630B	80017861
Q563	79EN0132	FET N IRFS654B	80017881
Q564	79EN0132	FET N IRFS654B	80017881
Q565	79EN0760	FET N IRFS640B	80017871
Q566	79EN0760	FET N IRFS640B	80017871
Q567	79EN0132	FET N IRFS654B	80017881
Q568	79EN0760	FET N IRFS640B	80017871
Q569	79EN0396	TR SMD NPN KRC102S	80018261
Q570	79EN0396	TR SMD NPN KRC102S	80018261
Q571	79EN0396	TR SMD NPN KRC102S	80018261
Q572	79EN0396	TR SMD NPN KRC102S	80018261
Q573	79EN0396	TR SMD NPN KRC102S	80018261
Q574	79EN0396	TR SMD NPN KRC102S	80018261
Q575	79EN0396	TR SMD NPN KRC102S	80018261
Q576	79EN0396	TR SMD NPN KRC102S	80018261
Q5A1	79PQ2384	TR NPN KTC2026-Y/GR TO220	80009921
Q5A2	79PQ2385	TR PNP KTA1046-Y/GR TO220	80009911
Q5C0	79EN0396	TR SMD NPN KRC102S	80018261
Q5C2	79EN0030	TR 0.15A/50V KTC3875S-GR	80018291
Q5F0	79EN0342	TR NPN ET453MR-F143	80014291
Q5F1	79EN0410	FET P 2SJ512/A	80019321
Q600	79EN0030	TR 0.15A/50V KTC3875S-GR	80018291
Q601	79EN0380	TR DTC124EK/RT1N241C319	80015211
Q602	79EN0030	TR 0.15A/50V KTC3875S-GR	80018291
Q603	79EN0380	TR DTC124EK/RT1N241C319	80015211
Q604	79EN0380	TR DTC124EK/RT1N241C319	80015211
Q605	79EN0031	TR 0.15A/50V KTA1504S-GR	80018321
Q701	79PQ0791	FET N 2SK2645-01/MR	80000981
Q702	79EN0030	TR 0.15A/50V KTC3875S-GR	80018291
Q703	79EN0031	TR 0.15A/50V KTA1504S-GR	80018321
Q704	79EN0396	TR SMD NPN KRC102S	80018261
Q7A1	79PQ2020	TR NPN 2SC4620 P-TV2	80008211
Q7B1	79EN0344	TR NPN KTC4370/A Y TO-220	80014351
Q7B2	79EN0345	TR PNP KTA1659/A Y TO-220	80014361
Q7B3	79EN0400	TR NPN KTC3200-GR TO-92(T)	80018411
Q7B4	79EN0033	TR PNP KTA1268-GR TO-92	80018441
Q7B5	79EN0400	TR NPN KTC3200-GR TO-92(T)	80018411
Q8Q0	79PQ5459	TR 2SD2012 NPN	EC000510
Q8Q1	79PQ5498	TR 2SB1375 PNP	ED000110
Q901	79EN0348	FET N 2SK2148-01R TO-3PF	80014411
Q902	79EN0347	TR PNP KR224M TO-92(T)	80014401
Q903	79EN0396	TR SMD NPN KRC102S	80018261
Q904	79EN0397	TR SMD PNP KRA107S	80018301

ALL PARTS LIST

MODEL: Diamond Pro 2070SB-BK(R)

LOCATION	PART No.	DESCRIPTION/SPECIFICATION	
Q905	79EN0030	TR 0.15A/50V KTC3875S-GR	80018291
Q950	79EN0399	TR NPN KRC105M TO-92(T)	80018381
Q961	79EN0397	TR SMD PNP KRA107S	80018301
Q962	79PQ2529	TR NPN KRC102M TO-92(T)	80014321
Q966	79PQ1685	TR PNP 2SA1020Y T0-92(T)	EBA10205
Q967	79PQ2529	TR NPN KRC102M TO-92(T)	80014321
<b>***RESISTOR***</b>			
JP1	79EN0189	R SMD 1/4W(T) 5% 0	FM110000
JP10	79PQ1890	CHIP 1/8W(T) 5% 0 H	FM100000
JP11	79PQ1890	CHIP 1/8W(T) 5% 0 H	FM100000
JP12	79EN0189	R SMD 1/4W(T) 5% 0	FM110000
JP13	79PQ1890	CHIP 1/8W(T) 5% 0 H	FM100000
JP14	79PQ1890	CHIP 1/8W(T) 5% 0 H	FM100000
JP15	79EN0189	R SMD 1/4W(T) 5% 0	FM110000
JP16	79PQ1890	CHIP 1/8W(T) 5% 0 H	FM100000
JP17	79EN0189	R SMD 1/4W(T) 5% 0	FM110000
JP18	79PQ1890	CHIP 1/8W(T) 5% 0 H	FM100000
JP2	79PQ1890	CHIP 1/8W(T) 5% 0 H	FM100000
JP20	79EN0189	R SMD 1/4W(T) 5% 0	FM110000
JP21	79EN0189	R SMD 1/4W(T) 5% 0	FM110000
JP22	79EN0189	R SMD 1/4W(T) 5% 0	FM110000
JP24	79EN0189	R SMD 1/4W(T) 5% 0	FM110000
JP3	79PQ1890	CHIP 1/8W(T) 5% 0 H	FM100000
JP4	79PQ1890	CHIP 1/8W(T) 5% 0 H	FM100000
JP5	79EN0189	R SMD 1/4W(T) 5% 0	FM110000
JP6	79PQ1890	CHIP 1/8W(T) 5% 0 H	FM100000
JP7	79EN0189	R SMD 1/4W(T) 5% 0	FM110000
JP71	79PQ1890	CHIP 1/8W(T) 5% 0 H	FM100000
JP8	79PQ1890	CHIP 1/8W(T) 5% 0 H	FM100000
JP9	79EN0189	R SMD 1/4W(T) 5% 0	FM110000
JP91	79PQ1890	CHIP 1/8W(T) 5% 0 H	FM100000
R100	79EN0226	R SMD 1/8W(T) 5% 2.2K	FM100222
R101	79PQ1840	CARBON 1/4W/M(T) 5% 470H	FA270471
R102	79PQ1893	CHIP 1/8W(T) 5% 10K	FM100103
R103	79PQ1893	CHIP 1/8W(T) 5% 10K	FM100103
R106	79PQ2003	CARBON 1/4W/M(T) 5% 10K	FA270103
R107	79EN0453	R METAL 1/4W/M(T) 1% 220	FB272200
R108	79PQ2003	CARBON 1/4W/M(T) 5% 10K	FA270103
R109	79EN0436	R CARBON 1/4W/M T 5% 4.7K	FA270472
R10B	79PQ1861	METAL 1/4W/M(T) 1% 1K	FB271001
R10C	79PQ1861	METAL 1/4W/M(T) 1% 1K	FB271001
R10D	79EN0455	R METAL 1/4W/M(T) 1% 2.7K	FB272701
R10E	79EN0465	R METAL 1/4W/M(T) 1% 910	FB279100
R10F	79EN0523	JUMPER WIRE	R0319110
R10G	79EN0456	R METAL 1/4W/M(T) 1% 330	FB273300
R10H	79PQ1891	CHIP 1/8W(T) 5% 100H	FM100101
R10J	79PQ1891	CHIP 1/8W(T) 5% 100H	FM100101
R10K	79EN0455	R METAL 1/4W/M(T) 1% 2.7K	FB272701
R10L	79EN0460	R METAL 1/4W/M(T) 1% 510	FB275100
R10M	79PQ1890	CHIP 1/8W(T) 5% 0 H	FM100000
R10Q	79PQ1890	CHIP 1/8W(T) 5% 0 H	FM100000
R10R	79PQ1893	CHIP 1/8W(T) 5% 10K	FM100103
R10S	79PQ1893	CHIP 1/8W(T) 5% 10K	FM100103
R10T	79PQ1827	CARBON 1/4W/M(T) 5% 100H	FA270101
R10U	79PQ1827	CARBON 1/4W/M(T) 5% 100H	FA270101
R10V	79PQ1891	CHIP 1/8W(T) 5% 100H	FM100101
R10W	79PQ2009	CARBON 1/4W/M(T) 5% 47H	FA270470
R10Y	79EN0523	JUMPER WIRE	R0319110
R110	79EN0456	R METAL 1/4W/M(T) 1% 330	FB273300
R111	79PQ1827	CARBON 1/4W/M(T) 5% 100H	FA270101
R112	79PQ1827	CARBON 1/4W/M(T) 5% 100H	FA270101
R113	79PQ1827	CARBON 1/4W/M(T) 5% 100H	FA270101
R114	79PQ1827	CARBON 1/4W/M(T) 5% 100H	FA270101
R115	79PQ1827	CARBON 1/4W/M(T) 5% 100H	FA270101
R116	79PQ1827	CARBON 1/4W/M(T) 5% 100H	FA270101
R117	79PQ1827	CARBON 1/4W/M(T) 5% 100H	FA270101
R118	79PQ1827	CARBON 1/4W/M(T) 5% 100H	FA270101
R119	79PQ1827	CARBON 1/4W/M(T) 5% 100H	FA270101
R11A	79EN0233	R SMD 1/8W(T) 5% 47K	FM100473
R11E	79PQ1853	CARBON 1/2W/M(T) 5% 220H	FA360221
R120	79PQ1827	CARBON 1/4W/M(T) 5% 100H	FA270101
R127	79PQ1828	CARBON 1/4W/M(T) 5% 1K	FA270102
R128	79PQ1827	CARBON 1/4W/M(T) 5% 100H	FA270101
R130	79EN0427	R CARBON 1/4W/M(T) 5% 10	FA270100

ALL PARTS LIST

MODEL: Diamond Pro 2070SB-BK(R)

LOCATION	PART No.	DESCRIPTION/SPECIFICATION	
R131	79PQ1827	CARBON 1/4W/M(T) 5% 100H	FA270101
R132	79PQ1827	CARBON 1/4W/M(T) 5% 100H	FA270101
R133	79PQ1827	CARBON 1/4W/M(T) 5% 100H	FA270101
R134	79PQ1893	CHIP 1/8W(T) 5% 10K	FM100103
R135	79PQ2003	CARBON 1/4W/M(T) 5% 10K	FA270103
R136	79PQ1894	CHIP 1/8W(T) 5% 1.5K	FM100152
R137	79PQ1902	CHIP 1/8W(T) 1% 10K	FN101002
R138	79EN0192	R SMD 1/8W(T) 1% 100K	FN101003
R139	79EN0225	R SMD 1/8W(T) 5% 1M	FM100105
R140	79PQ1890	CHIP 1/8W(T) 5% 0 H	FM100000
R141	79PQ2003	CARBON 1/4W/M(T) 5% 10K	FA270103
R142	79PQ2003	CARBON 1/4W/M(T) 5% 10K	FA270103
R143	79PQ1827	CARBON 1/4W/M(T) 5% 100H	FA270101
R144	79PQ1891	CHIP 1/8W(T) 5% 100H	FM100101
R145	79PQ1827	CARBON 1/4W/M(T) 5% 100H	FA270101
R146	79PQ1890	CHIP 1/8W(T) 5% 0 H	FM100000
R147	79PQ1890	CHIP 1/8W(T) 5% 0 H	FM100000
R148	79PQ1893	CHIP 1/8W(T) 5% 10K	FM100103
R149	79PQ1891	CHIP 1/8W(T) 5% 100H	FM100101
R150	79PQ1891	CHIP 1/8W(T) 5% 100H	FM100101
R151	79PQ1864	METAL 1/4W/M(T) 1% 18K	FB271802
R152	79EN0218	R SMD 1/8W(T) 1% 7.5K	FN107501
R153	79PQ1891	CHIP 1/8W(T) 5% 100H	FM100101
R154	79PQ2003	CARBON 1/4W/M(T) 5% 10K	FA270103
R155	79PQ1827	CARBON 1/4W/M(T) 5% 100H	FA270101
R156	79PQ1827	CARBON 1/4W/M(T) 5% 100H	FA270101
R157	79PQ1862	METAL 1/4W/M(T) 1% 10K	FB271002
R158	79PQ1891	CHIP 1/8W(T) 5% 100H	FM100101
R159	79PQ1840	CARBON 1/4W/M(T) 5% 470H	FA270471
R160	79PQ2003	CARBON 1/4W/M(T) 5% 10K	FA270103
R161	79PQ1827	CARBON 1/4W/M(T) 5% 100H	FA270101
R162	79PQ1895	CHIP 1/8W(T) 5% 1.8K	FM100182
R163	79PQ1895	CHIP 1/8W(T) 5% 1.8K	FM100182
R164	79EN0231	R SMD 1/8W(T) 5% 39	FM100390
R165	79EN0231	R SMD 1/8W(T) 5% 39	FM100390
R166	79PQ1893	CHIP 1/8W(T) 5% 10K	FM100103
R167	79EN0233	R SMD 1/8W(T) 5% 47K	FM100473
R168	79PQ1891	CHIP 1/8W(T) 5% 100H	FM100101
R169	79PQ1891	CHIP 1/8W(T) 5% 100H	FM100101
R16A	79PQ1827	CARBON 1/4W/M(T) 5% 100H	FA270101
R170	79PQ1891	CHIP 1/8W(T) 5% 100H	FM100101
R171	79PQ1893	CHIP 1/8W(T) 5% 10K	FM100103
R172	79PQ1893	CHIP 1/8W(T) 5% 10K	FM100103
R173	79PQ1893	CHIP 1/8W(T) 5% 10K	FM100103
R174	79PQ1828	CARBON 1/4W/M(T) 5% 1K	FA270102
R175	79EN0523	JUMPER WIRE	R0319110
R176	79PQ1891	CHIP 1/8W(T) 5% 100H	FM100101
R177	79PQ1890	CHIP 1/8W(T) 5% 0 H	FM100000
R178	79PQ1827	CARBON 1/4W/M(T) 5% 100H	FA270101
R179	79PQ2009	CARBON 1/4W/M(T) 5% 47H	FA270470
R180	79PQ2009	CARBON 1/4W/M(T) 5% 47H	FA270470
R181	79PQ1862	METAL 1/4W/M(T) 1% 10K	FB271002
R182	79PQ1870	METAL 1/4W/M(T) 1% 33K	FB273302
R184	79PQ1827	CARBON 1/4W/M(T) 5% 100H	FA270101
R185	79PQ1902	CHIP 1/8W(T) 1% 10K	FN101002
R186	79PQ1892	CHIP 1/8W(T) 5% 1K	FM100102
R187	79PQ1892	CHIP 1/8W(T) 5% 1K	FM100102
R188	79EN0214	R SMD 1/8W(T) 1% 4.7K	FN104701
R189	79EN0233	R SMD 1/8W(T) 5% 47K	FM100473
R190	79EN0427	R CARBON 1/4W/M(T) 5% 10	FA270100
R192	79EN0214	R SMD 1/8W(T) 1% 4.7K	FN104701
R194	79EN0202	R SMD 1/8W(T) 1% 2.2K	FN102201
R195	79PQ1896	CHIP 1/8W(T) 5% 220H	FM100221
R196	79EN0202	R SMD 1/8W(T) 1% 2.2K	FN102201
R197	79PQ1891	CHIP 1/8W(T) 5% 100H	FM100101
R198	79PQ1890	CHIP 1/8W(T) 5% 0 H	FM100000
R199	79PQ1890	CHIP 1/8W(T) 5% 0 H	FM100000
R1A0	79EN0221	R SMD 1/8W(T) 5% 100K	FM100104
R1A2	79EN0221	R SMD 1/8W(T) 5% 100K	FM100104
R1A4	79EN0228	R SMD 1/8W(T) 5% 27	FM100270
R1A5	79EN0228	R SMD 1/8W(T) 5% 27	FM100270
R1A6	79EN0227	R SMD 1/8W(T) 5% 22	FM100220
R1A7	79EN0227	R SMD 1/8W(T) 5% 22	FM100220
R1B0	79EN0224	R SMD 1/8W(T) 5% 15K	FM100153



ALL PARTS LIST

MODEL: Diamond Pro 2070SB-BK(R)

LOCATION	PART No.	DESCRIPTION/SPECIFICATION	
R1B1	79EN0224	R SMD 1/8W(T) 5% 15K	FM100153
R1B2	79EN0224	R SMD 1/8W(T) 5% 15K	FM100153
R1B3	79EN0224	R SMD 1/8W(T) 5% 15K	FM100153
R1B5	79EN0228	R SMD 1/8W(T) 5% 27	FM100270
R1B6	79EN0228	R SMD 1/8W(T) 5% 27	FM100270
R1B7	79EN0224	R SMD 1/8W(T) 5% 15K	FM100153
R1B8	79EN0224	R SMD 1/8W(T) 5% 15K	FM100153
R1B9	79PQ1890	CHIP 1/8W(T) 5% 0 H	FM100000
R1C2	79PQ1899	CHIP 1/8W(T) 5% 4.7K	FM100472
R1C3	79PQ1890	CHIP 1/8W(T) 5% 0 H	FM100000
R1C7	79EN0221	R SMD 1/8W(T) 5% 100K	FM100104
R1C8	79PQ1893	CHIP 1/8W(T) 5% 10K	FM100103
R1D1	79PQ1900	CHIP 1/8W(T) 5% 5.6K	FM100562
R1D2	79PQ1892	CHIP 1/8W(T) 5% 1K	FM100102
R1D3	79PQ1892	CHIP 1/8W(T) 5% 1K	FM100102
R1D4	79PQ1892	CHIP 1/8W(T) 5% 1K	FM100102
R1D6	79PQ1892	CHIP 1/8W(T) 5% 1K	FM100102
R1D7	79EN0228	R SMD 1/8W(T) 5% 27	FM100270
R1D8	79EN0228	R SMD 1/8W(T) 5% 27	FM100270
R1D9	79EN0224	R SMD 1/8W(T) 5% 15K	FM100153
R1E0	79EN0224	R SMD 1/8W(T) 5% 15K	FM100153
R1E1	79EN0221	R SMD 1/8W(T) 5% 100K	FM100104
R1E4	79PQ1890	CHIP 1/8W(T) 5% 0 H	FM100000
R1E5	79PQ1890	CHIP 1/8W(T) 5% 0 H	FM100000
R1E6	79PQ1893	CHIP 1/8W(T) 5% 10K	FM100103
R200B	79EN0443	R CARBON 1/2W/M(T) 5% 33	FA360330
R200G	79EN0443	R CARBON 1/2W/M(T) 5% 33	FA360330
R200R	79EN0443	R CARBON 1/2W/M(T) 5% 33	FA360330
R203H	79EN0440	R CARBON 1/2W/M(T) 5% 1.2	FA360129
R205S	79EN0382	R CARBON 1/2W/M(T) 5% 220	80015271
R210B	79PQ5573	RES CARBON 1/2W/M(T) 5% 5	FA360560
R210G	79PQ5574	RES CARBON 1/2W/M(T) 5% 6	FA360680
R210R	79PQ5573	RES CARBON 1/2W/M(T) 5% 5	FA360560
R211B	79EN0430	R CARBON 1/4W/M(T) 5% 150	FA270151
R211G	79PQ5569	RES CARBON 1/4W/M(T) 5% 1	FA270181
R211R	79EN0430	R CARBON 1/4W/M(T) 5% 150	FA270151
R212B	79PQ5581	RES SMD 1/8W(T) 1% 180OHM	FN101800
R212G	79PQ5581	RES SMD 1/8W(T) 1% 180OHM	FN101800
R212R	79PQ5581	RES SMD 1/8W(T) 1% 180OHM	FN101800
R220B	79EN0190	R SMD 1/4W(T) 5% 10	FM110100
R220G	79EN0190	R SMD 1/4W(T) 5% 10	FM110100
R220R	79EN0190	R SMD 1/4W(T) 5% 10	FM110100
R222B	79PQ5578	RES SMD 1/8W(T) 5% 68OHM	FM100680
R222G	79PQ5578	RES SMD 1/8W(T) 5% 68OHM	FM100680
R222R	79PQ5578	RES SMD 1/8W(T) 5% 68OHM	FM100680
R223B	79EN0222	R SMD 1/8W(T) 5% 10	FM100100
R223G	79EN0222	R SMD 1/8W(T) 5% 10	FM100100
R223R	79EN0222	R SMD 1/8W(T) 5% 10	FM100100
R224B	79EN0188	R SMD 1/4W(T) 1% 75	FN117509
R224G	79EN0188	R SMD 1/4W(T) 1% 75	FN117509
R224R	79EN0188	R SMD 1/4W(T) 1% 75	FN117509
R225B	79PQ5577	RES SMD 1/8W(T) 5% 1.8KOH	FM100182
R225G	79PQ5577	RES SMD 1/8W(T) 5% 1.8KOH	FM100182
R225R	79PQ5577	RES SMD 1/8W(T) 5% 1.8KOH	FM100182
R240B	79EN0222	R SMD 1/8W(T) 5% 10	FM100100
R240G	79EN0222	R SMD 1/8W(T) 5% 10	FM100100
R240R	79EN0222	R SMD 1/8W(T) 5% 10	FM100100
R241B	79EN0188	R SMD 1/4W(T) 1% 75	FN117509
R241G	79EN0188	R SMD 1/4W(T) 1% 75	FN117509
R241R	79EN0188	R SMD 1/4W(T) 1% 75	FN117509
R250B	79PQ5572	RES CARBON 1/2W/M(T) 5% 1	FA360184
R250G	79PQ5572	RES CARBON 1/2W/M(T) 5% 1	FA360184
R250R	79PQ5572	RES CARBON 1/2W/M(T) 5% 1	FA360184
R251B	79PQ1854	CARBON 1/2W/M(T) 5% 220K	FA360224
R251G	79PQ1854	CARBON 1/2W/M(T) 5% 220K	FA360224
R251R	79PQ1854	CARBON 1/2W/M(T) 5% 220K	FA360224
R252B	79PQ2005	CARBON 1/4W/M(T) 5% 22K	FA270223
R252G	79PQ2005	CARBON 1/4W/M(T) 5% 22K	FA270223
R252R	79PQ2005	CARBON 1/4W/M(T) 5% 22K	FA270223
R253B	79EN0222	R SMD 1/8W(T) 5% 10	FM100100
R253G	79EN0222	R SMD 1/8W(T) 5% 10	FM100100
R253R	79EN0222	R SMD 1/8W(T) 5% 10	FM100100
R254B	79PQ1903	CHIP 1/8W(T) 1% 13K	FN101302
R254G	79PQ1903	CHIP 1/8W(T) 1% 13K	FN101302

ALL PARTS LIST

MODEL: Diamond Pro 2070SB-BK(R)

LOCATION	PART No.	DESCRIPTION/SPECIFICATION	
R254R	79PQ1903	CHIP 1/8W(T) 1% 13K	FN101302
R255B	79EN0211	R SMD 1/8W(T) 1% 36K	FN103602
R255G	79EN0211	R SMD 1/8W(T) 1% 36K	FN103602
R255R	79EN0211	R SMD 1/8W(T) 1% 36K	FN103602
R256B	79PQ1905	CHIP 1/8W(T) 1% 22K	FN102202
R256G	79PQ1905	CHIP 1/8W(T) 1% 22K	FN102202
R256R	79PQ1905	CHIP 1/8W(T) 1% 22K	FN102202
R260	79EN0218	R SMD 1/8W(T) 1% 7.5K	FN107501
R261	79PQ1910	CHIP 1/8W(T) 1% 5.6K	FN105601
R263	79PQ1905	CHIP 1/8W(T) 1% 22K	FN102202
R264	79PQ2145	CHIP 1/8W(T) 1% 6.8K	FN106801
R265	79PQ1891	CHIP 1/8W(T) 5% 100H	FM100101
R266	79PQ1891	CHIP 1/8W(T) 5% 100H	FM100101
R267	79PQ1905	CHIP 1/8W(T) 1% 22K	FN102202
R268	79EN0204	R SMD 1/8W(T) 1% 20K	FN102002
R269	79PQ1891	CHIP 1/8W(T) 5% 100H	FM100101
R272	79PQ1891	CHIP 1/8W(T) 5% 100H	FM100101
R277	79PQ5582	RES SMD 1/8W(T) 1% 2.7KOH	FN102701
R279	79EN0229	R SMD 1/8W(T) 5% 3.3K	FM100332
R280	79PQ1893	CHIP 1/8W(T) 5% 10K	FM100103
R282	79PQ1827	CARBON 1/4W/M(T) 5% 100H	FA270101
R283	79PQ1827	CARBON 1/4W/M(T) 5% 100H	FA270101
R284	79PQ5576	RES SMD 1/8W(T) 5% 1MOHM	FM100105
R285	79PQ5570	RES CARBON 1/4W/M(T) 5% 4	FA270470
R286	79PQ5571	RES CARBON 1/4W/M(T) 5% 4	FA270472
R289	79PQ1899	CHIP 1/8W(T) 5% 4.7K	FM100472
R28A	79PQ1899	CHIP 1/8W(T) 5% 4.7K	FM100472
R293	79PQ2003	CARBON 1/4W/M(T) 5% 10K	FA270103
R294	79PQ1896	CHIP 1/8W(T) 5% 220H	FM100221
R295	79PQ1893	CHIP 1/8W(T) 5% 10K	FM100103
R296	79PQ1893	CHIP 1/8W(T) 5% 10K	FM100103
R2A4	79PQ1899	CHIP 1/8W(T) 5% 4.7K	FM100472
R2A6	79EN0233	R SMD 1/8W(T) 5% 47K	FM100473
R2A7	79EN0224	R SMD 1/8W(T) 5% 15K	FM100153
R2A8	79PQ5570	RES CARBON 1/4W/M(T) 5% 4	FA270470
R2A9	79PQ1827	CARBON 1/4W/M(T) 5% 100H	FA270101
R2C0	79PQ1827	CARBON 1/4W/M(T) 5% 100H	FA270101
R2C1	79PQ1827	CARBON 1/4W/M(T) 5% 100H	FA270101
R2C2	79EN0224	R SMD 1/8W(T) 5% 15K	FM100153
R2C3	79EN0233	R SMD 1/8W(T) 5% 47K	FM100473
R2C4	79EN0222	R SMD 1/8W(T) 5% 10	FM100100
R2C5	79PQ1891	CHIP 1/8W(T) 5% 100H	FM100101
R2D0	79PQ1827	CARBON 1/4W/M(T) 5% 100H	FA270101
R2D1	79PQ1827	CARBON 1/4W/M(T) 5% 100H	FA270101
R2D2	79PQ1827	CARBON 1/4W/M(T) 5% 100H	FA270101
R2D3	79PQ1910	CHIP 1/8W(T) 1% 5.6K	FN105601
R2D4	79EN0427	R CARBON 1/4W/M(T) 5% 10	FA270100
R2D5	79PQ1891	CHIP 1/8W(T) 5% 100H	FM100101
R2D6	79EN0233	R SMD 1/8W(T) 5% 47K	FM100473
R2E0	79PQ2003	CARBON 1/4W/M(T) 5% 10K	FA270103
R2E3	79EN0201	R SMD 1/8W(T) 1% 1M	FN101004
R2E4	79PQ1910	CHIP 1/8W(T) 1% 5.6K	FN105601
R2E5	79EN0229	R SMD 1/8W(T) 5% 3.3K	FM100332
R2F1	79PQ1892	CHIP 1/8W(T) 5% 1K	FM100102
R2F2	79PQ1892	CHIP 1/8W(T) 5% 1K	FM100102
R2F3	79PQ1892	CHIP 1/8W(T) 5% 1K	FM100102
R2F4	79PQ1892	CHIP 1/8W(T) 5% 1K	FM100102
R2F5	79EN0196	R SMD 1/8W(T) 1% 150	FN101500
R2F6	79PQ1827	CARBON 1/4W/M(T) 5% 100H	FA270101
R2H0	79EN0202	R SMD 1/8W(T) 1% 2.2K	FN102201
R2H1	79EN0234	R SMD 1/8W(T) 5% 47	FM100470
R2H5	79EN0202	R SMD 1/8W(T) 1% 2.2K	FN102201
R2H6	79EN0234	R SMD 1/8W(T) 5% 47	FM100470
R2H8	79EN0234	R SMD 1/8W(T) 5% 47	FM100470
R2P0	79PQ1847	CARBON 1/2W/M(T) 5% 100H	FA360101
R2P1	79PQ1899	CHIP 1/8W(T) 5% 4.7K	FM100472
R2P2	79PQ5549	RES SMD 1/8W(T) 5% 1.2KOH	FM100122
R2P3	79PQ1892	CHIP 1/8W(T) 5% 1K	FM100102
R2P4	79PQ1893	CHIP 1/8W(T) 5% 10K	FM100103
R2P5	79PQ1893	CHIP 1/8W(T) 5% 10K	FM100103
R2P6	79EN0229	R SMD 1/8W(T) 5% 3.3K	FM100332
R2S2	79PQ1891	CHIP 1/8W(T) 5% 100H	FM100101
R2S3	79PQ1891	CHIP 1/8W(T) 5% 100H	FM100101
R2V0	79EN0202	R SMD 1/8W(T) 1% 2.2K	FN102201

ALL PARTS LIST

MODEL: Diamond Pro 2070SB-BK(R)

LOCATION	PART No.	DESCRIPTION/SPECIFICATION	
R2V1	79PQ5570	RES CARBON 1/4W/M(T) 5% 4	FA270470
R2V5	79EN0202	R SMD 1/8W(T) 1% 2.2K	FN102201
R2V6	79EN0234	R SMD 1/8W(T) 5% 47	FM100470
R2V8	79EN0234	R SMD 1/8W(T) 5% 47	FM100470
R2W0	79PQ1891	CHIP 1/8W(T) 5% 100H	FM100101
R2W1	79PQ1891	CHIP 1/8W(T) 5% 100H	FM100101
R2W2	79EN0427	R CARBON 1/4W/M(T) 5% 10	FA270100
R2W3	79EN0427	R CARBON 1/4W/M(T) 5% 10	FA270100
R2W4	79EN0236	R SMD 1/8W(T) 5% 6.8K	FM100682
R2W5	79EN0236	R SMD 1/8W(T) 5% 6.8K	FM100682
R403	79EN0469	R MOF 1W/M(B) 5% 270	FB480271
R404	79PQ1830	CARBON 1/4W/M(T) 5% 1H	FA270109
R405	79EN0464	R METAL 1/4W/M(T) 1% 6.2K	FB276201
R406	79PQ1910	CHIP 1/8W(T) 1% 5.6K	FN105601
R407	79PQ1966	METAL 1/4W/M(T) 1% 4.7K	FB274701
R408	79EN0458	R METAL 1/4W/M(T) 1% 3.9K	FB273901
R409	79PQ1967	METAL 1/4W/M(T) 1% 5.6K	FB275601
R410	79EN0148	R MFF/B 2W M1% 0.56 +/-50	80019391
R411	79PQ2170	CHIP 1/8W(T) 1% 6.2K	FN106201
R417	79EN0144	R CARBON 1/2W/M(T) 5% 330	FA360331
R418	79EN0147	R METAL /T 1/4W M 5% 510	80018471
R419	79EN0147	R METAL /T 1/4W M 5% 510	80018471
R501	79PQ1827	CARBON 1/4W/M(T) 5% 100H	FA270101
R502	79PQ1893	CHIP 1/8W(T) 5% 10K	FM100103
R503	79PQ1835	CARBON 1/4W/M(T) 5% 2.2K	FA270222
R504	79PQ1892	CHIP 1/8W(T) 5% 1K	FM100102
R505	79EN0523	JUMPER WIRE	R0319110
R506	79EN0430	R CARBON 1/4W/M(T) 5% 150	FA270151
R507	79PQ1893	CHIP 1/8W(T) 5% 10K	FM100103
R508	79EN0331	R FUSE 1/2W(T) 5% 1	80013911
R509	79EN0448	R CARBON 1/2W/M(B) 5% 56	FA380560
R510	79PQ2447	MOF 3W/M(A) 5% 8.2H	FB710829
R511	79PQ2447	MOF 3W/M(A) 5% 8.2H	FB710829
R512	79PQ2447	MOF 3W/M(A) 5% 8.2H	FB710829
R513	79PQ2447	MOF 3W/M(A) 5% 8.2H	FB710829
R514	79EN0151	R MOF 3W/M(A) 5% 0.22	FB710228
R515	79PQ1063	MOF 1W/M(B) 5% 27H	FB480270
R560	79PQ1062	MOF 1W/M(B) 5% 100H	FB480101
R561	79EN0447	R CARBON 1/2W/M(T) 5% 680	FA360681
R562	79PQ1892	CHIP 1/8W(T) 5% 1K	FM100102
R563	79EN0154	R MOF 3W/M(A) 5% 82	FB710820
R564	79EN0154	R MOF 3W/M(A) 5% 82	FB710820
R565	79PQ1829	CARBON 1/4W/M(T) 5% 100K	FA270104
R566	79PQ1829	CARBON 1/4W/M(T) 5% 100K	FA270104
R567	79PQ1829	CARBON 1/4W/M(T) 5% 100K	FA270104
R568	79PQ1829	CARBON 1/4W/M(T) 5% 100K	FA270104
R569	79PQ1829	CARBON 1/4W/M(T) 5% 100K	FA270104
R570	79EN0433	R CARBON 1/4W/M(T) 5% 220	FA270221
R571	79EN0433	R CARBON 1/4W/M(T) 5% 220	FA270221
R572	79EN0433	R CARBON 1/4W/M(T) 5% 220	FA270221
R573	79EN0433	R CARBON 1/4W/M(T) 5% 220	FA270221
R574	79EN0433	R CARBON 1/4W/M(T) 5% 220	FA270221
R575	79EN0433	R CARBON 1/4W/M(T) 5% 220	FA270221
R576	79PQ1829	CARBON 1/4W/M(T) 5% 100K	FA270104
R577	79PQ1829	CARBON 1/4W/M(T) 5% 100K	FA270104
R578	79EN0433	R CARBON 1/4W/M(T) 5% 220	FA270221
R579	79EN0433	R CARBON 1/4W/M(T) 5% 220	FA270221
R580	79PQ1829	CARBON 1/4W/M(T) 5% 100K	FA270104
R581	79PQ2005	CARBON 1/4W/M(T) 5% 22K	FA270223
R582	79PQ2005	CARBON 1/4W/M(T) 5% 22K	FA270223
R583	79PQ2005	CARBON 1/4W/M(T) 5% 22K	FA270223
R584	79PQ2005	CARBON 1/4W/M(T) 5% 22K	FA270223
R585	79PQ2005	CARBON 1/4W/M(T) 5% 22K	FA270223
R586	79PQ2005	CARBON 1/4W/M(T) 5% 22K	FA270223
R587	79PQ2005	CARBON 1/4W/M(T) 5% 22K	FA270223
R588	79PQ2005	CARBON 1/4W/M(T) 5% 22K	FA270223
R5A3	79PQ1840	CARBON 1/4W/M(T) 5% 470H	FA270471
R5A4	79PQ1840	CARBON 1/4W/M(T) 5% 470H	FA270471
R5C0	79PQ1891	CHIP 1/8W(T) 5% 100H	FM100101
R5C1	79EN0218	R SMD 1/8W(T) 1% 7.5K	FN107501
R5C2	79PQ1877	METAL 1/4W/M(T) 1% 91K	FB279102
R5C3	79EN0437	R CARBON 1/4W/M(T) 5% 47K	FA270473
R5C4	79EN0219	R SMD 1/8W(T) 1% 82K	FN108202
R5C5	79EN0233	R SMD 1/8W(T) 5% 47K	FM100473

ALL PARTS LIST

MODEL: Diamond Pro 2070SB-BK(R)

LOCATION	PART No.	DESCRIPTION/SPECIFICATION	
R5C6	79EN0766	R CAR 1/4W/M(T) 5% 33K	FA270333
R5C8	79EN0624	R CHIP 1/8W(T) 5% 820	FM100821
R5C9	79PQ1892	CHIP 1/8W(T) 5% 1K	FM100102
R5D0	79EN0216	R SMD 1/8W(T) 1% 510	FN105100
R5D1	79EN0523	JUMPER WIRE	R0319110
R5D2	79EN0199	R SMD 1/8W(T) 1% 18K	FN101802
R5D3	79PQ1827	CARBON 1/4W/M(T) 5% 100H	FA270101
R5D4	79PQ1873	METAL 1/4W/M(T) 1% 6.8K	FB276801
R5D5	79PQ2145	CHIP 1/8W(T) 1% 6.8K	FN106801
R5D6	79PQ1907	CHIP 1/8W(T) 1% 33K	FN103302
R5D7	79PQ2003	CARBON 1/4W/M(T) 5% 10K	FA270103
R5D8	79EN0235	R SMD 1/8W(T) 5% 56	FM100560
R5E1	79PQ1893	CHIP 1/8W(T) 5% 10K	FM100103
R5E3	79PQ1898	CHIP 1/8W(T) 5% 33K	FM100333
R5E5	79PQ0176	MOF 1W/M(B) 5% 33OHM	FB480330
R5E6	79PQ1910	CHIP 1/8W(T) 1% 5.6K	FN105601
R5E7	79PQ2003	CARBON 1/4W/M(T) 5% 10K	FA270103
R5F0	79EN0330	R FUSE 1/2W(T) 5% 2.7K	80013901
R5F1	79EN0434	R CARBON 1/4W/M T 5% 330K	FA270334
R5F2	79EN0436	R CARBON 1/4W/M T 5% 4.7K	FA270472
R5F3	79EN0433	R CARBON 1/4W/M(T) 5% 220	FA270221
R5G0	79PQ0185	MOF 3W/M(A) 5% 5.6OHM	FB710569
R5G1	79EN0446	R CARBON 1/2W/M(T) 5% 56	FA360560
R5G2	79PQ1859	CARBON 1/2W/M(T) 5% 68H	FA360680
R5G3	79EN0445	R CARBON 1/2W/M(T) 5% 47	FA360470
R600	79EN0617	R CHIP 1/10W(T) 5% 2.2K	FM010222
R601	79EN0615	R CHIP 1/10W(T) 5% 100	FM010101
R602	79EN0184	R SMD 1/10W(T) 5% 33	FM010330
R603	79EN0184	R SMD 1/10W(T) 5% 33	FM010330
R604	79EN0181	R SMD 1/10W(T) 5% 220	FM010221
R605	79EN0179	R SMD 1/10W(T) 5% 10	FM010100
R606	79EN0181	R SMD 1/10W(T) 5% 220	FM010221
R607	79EN0181	R SMD 1/10W(T) 5% 220	FM010221
R608	79EN0181	R SMD 1/10W(T) 5% 220	FM010221
R609	79EN0183	R SMD 1/10W(T) 5% 33K	FM010333
R610	79EN0178	R SMD 1/10W(T) 5% 10K	FM010103
R611	79EN0183	R SMD 1/10W(T) 5% 33K	FM010333
R612	79EN0183	R SMD 1/10W(T) 5% 33K	FM010333
R613	79PQ5464	RES SMD 1/10W(T) 1% 3KOHM	FN013001
R614	79EN0180	R SMD 1/10W(T) 5% 1K	FM010102
R615	79EN0178	R SMD 1/10W(T) 5% 10K	FM010103
R616	79EN0178	R SMD 1/10W(T) 5% 10K	FM010103
R617	79EN0183	R SMD 1/10W(T) 5% 33K	FM010333
R618	79EN0186	R SMD 1/10W(T) 5% 6.8K	FM010682
R619	79EN0180	R SMD 1/10W(T) 5% 1K	FM010102
R620	79EN0166	R SMD 1/10W(T) 1% 5.1K	FN015101
R621	79EN0180	R SMD 1/10W(T) 5% 1K	FM010102
R622	79EN0180	R SMD 1/10W(T) 5% 1K	FM010102
R623	79EN0175	R SMD 1/10W(T) 5% 0	FM010000
R624	79EN0179	R SMD 1/10W(T) 5% 10	FM010100
R625	79EN0180	R SMD 1/10W(T) 5% 1K	FM010102
R626	79EN0180	R SMD 1/10W(T) 5% 1K	FM010102
R627	79EN0185	R SMD 1/10W(T) 5% 4.7K	FM010472
R628	79EN0180	R SMD 1/10W(T) 5% 1K	FM010102
R629	79EN0174	R SMD 1/10W(T) 1% 910	FN019100
R630	79EN0176	R SMD 1/10W(T) 5% 1.5M	FM010155
R631	79EN0187	R SMD 1/10W(T) 5% 680	FM010681
R632	79EN0180	R SMD 1/10W(T) 5% 1K	FM010102
R633	79EN0170	R SMD 1/10W(T) 1% 750	FN017500
R634	79EN0171	R SMD 1/10W(T) 1% 75	FN017509
R635	79EN0177	R SMD 1/10W(T) 5% 100K	FM010104
R636	79EN0156	R SMD 1/10W(T) 1% 120	FN011200
R637	79EN0167	R SMD 1/10W(T) 1% 560	FN015600
R638	79EN0181	R SMD 1/10W(T) 5% 220	FM010221
R639	79EN0181	R SMD 1/10W(T) 5% 220	FM010221
R640	79EN0181	R SMD 1/10W(T) 5% 220	FM010221
R641	79EN0181	R SMD 1/10W(T) 5% 220	FM010221
R642	79EN0173	R SMD 1/10W(T) 1% 9.1K	FN019101
R643	79EN0159	R SMD 1/10W(T) 1% 1K	FN011001
R644	79EN0169	R SMD 1/10W(T) 1% 680	FN016800
R645	79EN0162	R SMD 1/10W(T) 1% 220K	FN012203
R646	79EN0163	R SMD 1/10W(T) 1% 3.9K	FN013901
R647	79EN0172	R SMD 1/10W(T) 1% 820K	FN018203
R648	79EN0155	R SMD 1/10W(T) 1% 1.6M	FN011604

ALL PARTS LIST

MODEL: Diamond Pro 2070SB-BK(R)

LOCATION	PART No.	DESCRIPTION/SPECIFICATION	
R649	79EN0168	R SMD 1/10W(T) 1% 680K	FN016803
R650	79EN0165	R SMD 1/10W(T) 1% 47K	FN014702
R651	79EN0165	R SMD 1/10W(T) 1% 47K	FN014702
R652	79EN0165	R SMD 1/10W(T) 1% 47K	FN014702
R653	79EN0165	R SMD 1/10W(T) 1% 47K	FN014702
R654	79EN0160	R SMD 1/10W(T) 1% 2.2K	FN012201
R655	79EN0160	R SMD 1/10W(T) 1% 2.2K	FN012201
R656	79EN0158	R SMD 1/10W(T) 1% 180	FN011800
R657	79EN0157	R SMD 1/10W(T) 1% 12K	FN011202
R658	79EN0164	R SMD 1/10W(T) 1% 39K	FN013902
R659	79EN0186	R SMD 1/10W(T) 5% 6.8K	FM010682
R660	79EN0186	R SMD 1/10W(T) 5% 6.8K	FM010682
R661	79EN0182	R SMD 1/10W(T) 5% 3.9K	FM010392
R662	79EN0182	R SMD 1/10W(T) 5% 3.9K	FM010392
R6A1	79EN0209	R SMD 1/8W(T) 1% 3.9K	FN103901
R6A2	79PQ1906	CHIP 1/8W(T) 1% 27K	FN102702
R6A3	79EN0451	R METAL 1/4W/M(T) 1% 15K	FB271502
R6A4	79PQ2144	METAL 1/4W/M(T) 1% 5.1K	FB275101
R6A5	79PQ1907	CHIP 1/8W(T) 1% 33K	FN103302
R6A6	79PQ1906	CHIP 1/8W(T) 1% 27K	FN102702
R6A7	79EN0451	R METAL 1/4W/M(T) 1% 15K	FB271502
R6A8	79EN0451	R METAL 1/4W/M(T) 1% 15K	FB271502
R6A9	79EN0209	R SMD 1/8W(T) 1% 3.9K	FN103901
R6B1	79EN0451	R METAL 1/4W/M(T) 1% 15K	FB271502
R6B2	79EN0215	R SMD 1/8W(T) 1% 43K	FN104302
R6B3	79PQ1862	METAL 1/4W/M(T) 1% 10K	FB271002
R6B4	79EN0450	R METAL 1/4W/M(T) 1% 12K	FB271202
R6B5	79EN0219	R SMD 1/8W(T) 1% 82K	FN108202
R6B6	79PQ1827	CARBON 1/4W/M(T) 5% 100H	FA270101
R6B7	79EN0455	R METAL 1/4W/M(T) 1% 2.7K	FB272701
R6B8	79EN0451	R METAL 1/4W/M(T) 1% 15K	FB271502
R6B9	79EN0213	R SMD 1/8W(T) 1% 39K	FN103902
R6C1	79EN0215	R SMD 1/8W(T) 1% 43K	FN104302
R6C2	79PQ1891	CHIP 1/8W(T) 5% 100H	FM100101
R6C3	79PQ1906	CHIP 1/8W(T) 1% 27K	FN102702
R6C4	79EN0194	R SMD 1/8W(T) 1% 12K	FN101202
R6C5	79PQ1862	METAL 1/4W/M(T) 1% 10K	FB271002
R6C6	79PQ1906	CHIP 1/8W(T) 1% 27K	FN102702
R6C7	79PQ1902	CHIP 1/8W(T) 1% 10K	FN101002
R6C8	79EN0199	R SMD 1/8W(T) 1% 18K	FN101802
R6C9	79EN0226	R SMD 1/8W(T) 5% 2.2K	FM100222
R6D1	79PQ1892	CHIP 1/8W(T) 5% 1K	FM100102
R6D2	79PQ1893	CHIP 1/8W(T) 5% 10K	FM100103
R6D3	79PQ1827	CARBON 1/4W/M(T) 5% 100H	FA270101
R6D4	79EN0232	R SMD 1/8W(T) 5% 470	FM100471
R6D5	79EN0235	R SMD 1/8W(T) 5% 56	FM100560
R6D6	79PQ1891	CHIP 1/8W(T) 5% 100H	FM100101
R6D7	79PQ1827	CARBON 1/4W/M(T) 5% 100H	FA270101
R701	79EN0153	R MOF 3W/M(A) 5% 75	FB710750
R702	79EN0153	R MOF 3W/M(A) 5% 75	FB710750
R703	79EN0153	R MOF 3W/M(A) 5% 75	FB710750
R704	79PQ1857	CARBON 1/2W/M(T) 5% 3.9K	FA360392
R705	79EN0331	R FUSE 1/2W(T) 5% 1	80013911
R706	79PQ1906	CHIP 1/8W(T) 1% 27K	FN102702
R707	79EN0214	R SMD 1/8W(T) 1% 4.7K	FN104701
R708	79EN0468	R MOF 1W/M(B) 5% 0.22	FB480228
R709	79EN0468	R MOF 1W/M(B) 5% 0.22	FB480228
R710	79EN0231	R SMD 1/8W(T) 5% 39	FM100390
R711	79PQ1833	CARBON 1/4W/M(T) 5% 1.8K	FA270182
R712	79EN0523	JUMPER WIRE	R0319110
R713	79PQ1901	CHIP 1/8W(T) 5% 8.2K	FM100822
R714	79PQ1892	CHIP 1/8W(T) 5% 1K	FM100102
R715	79PQ1893	CHIP 1/8W(T) 5% 10K	FM100103
R716	79EN0195	R SMD 1/8W(T) 1% 150K	FN101503
R717	79PQ1892	CHIP 1/8W(T) 5% 1K	FM100102
R718	79PQ1892	CHIP 1/8W(T) 5% 1K	FM100102
R719	79EN0233	R SMD 1/8W(T) 5% 47K	FM100473
R720	79PQ1874	METAL 1/4W/M(T) 1% 68K	FB276802
R721	79EN0233	R SMD 1/8W(T) 5% 47K	FM100473
R722	79PQ1871	METAL 1/4W/M(T) 1% 4.3K	FB274301
R723	79EN0219	R SMD 1/8W(T) 1% 82K	FN108202
R724	79EN0213	R SMD 1/8W(T) 1% 39K	FN103902
R725	79EN0192	R SMD 1/8W(T) 1% 100K	FN101003
R726	79EN0212	R SMD 1/8W(T) 1% 390K	FN103903

## ALL PARTS LIST

MODEL: Diamond Pro 2070SB-BK(R)

LOCATION	PART No.	DESCRIPTION/SPECIFICATION	
R727	79EN0193	R SMD 1/8W(T) 1% 120K	FN101203
R728	79PQ1870	METAL 1/4W/M(T) 1% 33K	FB273302
R729	79PQ1861	METAL 1/4W/M(T) 1% 1K	FB271001
R730	79EN0454	R METAL 1/4W/M(T) 1% 22K	FB272202
R732	79PQ1899	CHIP 1/8W(T) 5% 4.7K	FM100472
R733	79EN0191	R SMD 1/8W(T) 1% 1.5K	FN101501
R734	79EN0192	R SMD 1/8W(T) 1% 100K	FN101003
R735	79EN0226	R SMD 1/8W(T) 5% 2.2K	FM100222
R736	79PQ1893	CHIP 1/8W(T) 5% 10K	FM100103
R737	79EN0220	R SMD 1/8W(T) 5% 1.5M	FM100155
R738	79EN0431	R CARBON 1/4W/M T 5% 1.5M	FA270155
R739	79EN0191	R SMD 1/8W(T) 1% 1.5K	FN101501
R740	79EN0192	R SMD 1/8W(T) 1% 100K	FN101003
R741	79PQ1861	METAL 1/4W/M(T) 1% 1K	FB271001
R742	79PQ1902	CHIP 1/8W(T) 1% 10K	FN101002
R743	79EN0207	R SMD 1/8W(T) 1% 270K	FN102703
R744	79PQ1861	METAL 1/4W/M(T) 1% 1K	FB271001
R745	79EN0207	R SMD 1/8W(T) 1% 270K	FN102703
R746	79PQ2003	CARBON 1/4W/M(T) 5% 10K	FA270103
R747	79PQ1891	CHIP 1/8W(T) 5% 100H	FM100101
R748	79PQ1890	CHIP 1/8W(T) 5% 0 H	FM100000
R749	79EN0523	JUMPER WIRE	R0319110
R750	79EN0153	R MOF 3W/M(A) 5% 75	FB710750
R751	79EN0195	R SMD 1/8W(T) 1% 150K	FN101503
R752	79PQ1893	CHIP 1/8W(T) 5% 10K	FM100103
R760	79EN0765	R CAR 1/4W/M(T) 5% 2.7K	FA270272
R7A1	79EN0523	JUMPER WIRE	R0319110
R7A2	79EN0327	R SURGE 1/2W 5% 3.3K	80013811
R7A3	79EN0444	R CARBON 1/2W/M T 5% 330K	FA360334
R7A4	79PQ1876	METAL 1/4W/M(T) 1% 8.2K	FB278201
R7A5	79PQ1893	CHIP 1/8W(T) 5% 10K	FM100103
R7A6	79PQ1827	CARBON 1/4W/M(T) 5% 100H	FA270101
R7B1	79EN0391	R FUSE /T 1/4W 5% 10	80017981
R7B2	79EN0441	R CARBON 1/2W/M(T) 5% 18	FA360180
R7B5	79EN0329	R FUSE 1/4W(T) 5% 470	80013861
R7B6	79EN0467	R MOF 1W/M(B) 5% 10K	FB480103
R7B7	79EN0200	R SMD 1/8W(T) 1% 1K	FN101001
R7B9	79PQ1891	CHIP 1/8W(T) 5% 100H	FM100101
R802	79EN0210	R SMD 1/8W(T) 1% 30K	FN103002
R803	79PQ1905	CHIP 1/8W(T) 1% 22K	FN102202
R809	79EN0217	R SMD 1/8W(T) 1% 560K	FN105603
R811	79EN0217	R SMD 1/8W(T) 1% 560K	FN105603
R813	79EN0217	R SMD 1/8W(T) 1% 560K	FN105603
R817	79EN0449	R METAL 1/4W/M(T) 1% 100K	FB271003
R818	79EN0217	R SMD 1/8W(T) 1% 560K	FN105603
R820	79EN0449	R METAL 1/4W/M(T) 1% 100K	FB271003
R823	79EN0217	R SMD 1/8W(T) 1% 560K	FN105603
R825	79EN0449	R METAL 1/4W/M(T) 1% 100K	FB271003
R827	79EN0154	R MOF 3W/M(A) 5% 82	FB710820
R828	79EN0192	R SMD 1/8W(T) 1% 100K	FN101003
R829	79PQ1890	CHIP 1/8W(T) 5% 0 H	FM100000
R831	79EN0192	R SMD 1/8W(T) 1% 100K	FN101003
R832	79EN0449	R METAL 1/4W/M(T) 1% 100K	FB271003
R833	79PQ2144	METAL 1/4W/M(T) 1% 5.1K	FB275101
R834	79PQ1891	CHIP 1/8W(T) 5% 100H	FM100101
R835	79EN0154	R MOF 3W/M(A) 5% 82	FB710820
R8A2	79EN0208	R SMD 1/8W(T) 1% 3.3K	FN103301
R8A3	79PQ1892	CHIP 1/8W(T) 5% 1K	FM100102
R8A4	79EN0236	R SMD 1/8W(T) 5% 6.8K	FM100682
R8A5	79EN0236	R SMD 1/8W(T) 5% 6.8K	FM100682
R8A6	79PQ1070	MOF 3W/M(A) 5% 2.2H	FB710229
R8A7	79EN0471	RES MOF 2W/M(B) 5% 68	FB570680
R8A9	79EN0471	RES MOF 2W/M(B) 5% 68	FB570680
R8B1	79EN0208	R SMD 1/8W(T) 1% 3.3K	FN103301
R8B2	79PQ1892	CHIP 1/8W(T) 5% 1K	FM100102
R8B3	79EN0236	R SMD 1/8W(T) 5% 6.8K	FM100682
R8B4	79EN0236	R SMD 1/8W(T) 5% 6.8K	FM100682
R8B7	79EN0152	R MOF 3W/M(A) 5% 1	FB710010
R8P0	79EN0202	R SMD 1/8W(T) 1% 2.2K	FN102201
R8P1	79PQ5583	RES SMD 1/8W(T) 1% 30KOHM	FN103002
R8P2	79PQ5580	RES SMD 1/8W(T) 1% 15KOHM	FN101502
R8P3	79PQ5579	RES SMD 1/8W(T) 1% 100KOH	FN101003
R8P4	79PQ5584	RES SMD 1/8W(T) 1% 390KOH	FN103903
R8P5	79PQ5575	RES MOF 3W/M(A) 5% 82OHM	FB710820

ALL PARTS LIST

MODEL: Diamond Pro 2070SB-BK(R)

LOCATION	PART No.	DESCRIPTION/SPECIFICATION	
R8Q1	79EN0192	R SMD 1/8W(T) 1% 100K	FN101003
R8Q2	79PQ5465	RES SMD 1/8W(T) 1% 56KOHM	FN105602
R8Q3	79PQ2144	METAL 1/4W/M(T) 1% 5.1K	FB275101
R8Q4	79PQ1902	CHIP 1/8W(T) 1% 10K	FN101002
R8Q5	79PQ1893	CHIP 1/8W(T) 5% 10K	FM100103
R8Q6	79PQ1827	CARBON 1/4W/M(T) 5% 100H	FA270101
R8Q7	79PQ5463	RES MOF 3W/M(A) 5% 68OHM	FB710680
R8Q8	79PQ5507	RES MOF 3W/M(A) 5% 68OHM	FB710680
R8Q9	79PQ5507	RES MOF 3W/M(A) 5% 68OHM	FB710680
R8R0	79PQ1835	CARBON 1/4W/M(T) 5% 2.2K	FA270222
R8R1	79EN0226	R SMD 1/8W(T) 5% 2.2K	FM100222
R8R2	79PQ5499	RES MOF 2W/M(B) 5% 2.2OHM	FB570229
R8R3	79PQ5460	RES CARBON 1/4W/M(T) 5% 2	FA270229
R8R4	79PQ5461	RES MOF 2W/M(B) 5% 33OHM	FB570330
R8R5	79EN0208	R SMD 1/8W(T) 1% 3.3K	FN103301
R8R6	79EN0200	R SMD 1/8W(T) 1% 1K	FN101001
R8R7	79EN0221	R SMD 1/8W(T) 5% 100K	FM100104
R8R8	79PQ5462	RES MOF 2W/M(B) 5% 3.9OHM	FB570399
R901	79PQ1041	CARBON 1/2W(T) 5% 470K	FA330474
R904	79EN0459	R METAL 1/4W/M(T) 1% 470K	FB274703
R905	79EN0459	R METAL 1/4W/M(T) 1% 470K	FB274703
R906	79EN0205	R SMD 1/8W(T) 1% 220K	FN102203
R907	79EN0192	R SMD 1/8W(T) 1% 100K	FN101003
R908	79PQ1902	CHIP 1/8W(T) 1% 10K	FN101002
R909	79PQ1828	CARBON 1/4W/M(T) 5% 1K	FA270102
R910	79PQ1621	MOF 2W/M(B) 5% 0.22 OHM	FB570228
R911	79PQ1897	CHIP 1/8W(T) 5% 22K	FM100223
R912	79EN0429	R CARBON 1/4W/M(T) 5% 12	FA270120
R913	79EN0462	R METAL 1/4W/M(T) 1% 510K	FB275103
R914	79EN0462	R METAL 1/4W/M(T) 1% 510K	FB275103
R915	79EN0462	R METAL 1/4W/M(T) 1% 510K	FB275103
R916	79EN0206	R SMD 1/8W(T) 1% 24K	FN102402
R917	79PQ1902	CHIP 1/8W(T) 1% 10K	FN101002
R918	79EN0457	R METAL 1/4W/M(T) 1% 330K	FB273303
R919	79EN0457	R METAL 1/4W/M(T) 1% 330K	FB273303
R920	79EN0452	R METAL 1/4W/M(T) 1% 150K	FB271503
R921	79PQ1909	CHIP 1/8W(T) 1% 47K	FN104702
R922	79PQ2570	MOF 2W/M(B) 5% 68K	FB570683
R923	79PQ2570	MOF 2W/M(B) 5% 68K	FB570683
R924	79PQ1827	CARBON 1/4W/M(T) 5% 100H	FA270101
R925	79EN0203	R SMD 1/8W(T) 1% 2.4K	FN102401
R926	79EN0435	R CARBON 1/4W/M(T) 5% 3.9	FA270399
R927	79EN0237	R SMD 1/8W(T) 5% 680	FM100681
R928	79EN0401	R CEMENT/B 5W M 5% 0.33	80018461
R929	79PQ1869	METAL 1/4W/M(T) 1% 3.3K	FB273301
R933	79PQ1893	CHIP 1/8W(T) 5% 10K	FM100103
R934	79EN0429	R CARBON 1/4W/M(T) 5% 12	FA270120
R937	79PQ1621	MOF 2W/M(B) 5% 0.22 OHM	FB570228
R938	79PQ1836	CARBON 1/4W/M(T) 5% 270H	FA270271
R939	79EN0470	R MOF 2W/M(B) 5% 47K	FB570473
R940	79PQ2570	MOF 2W/M(B) 5% 68K	FB570683
R941	79PQ2570	MOF 2W/M(B) 5% 68K	FB570683
R944	79PQ1893	CHIP 1/8W(T) 5% 10K	FM100103
R946	79PQ1893	CHIP 1/8W(T) 5% 10K	FM100103
R950	79EN0438	R CARBON 1/4W/M(T) 5% 4.7	FA270479
R951	79PQ2003	CARBON 1/4W/M(T) 5% 10K	FA270103
R952	79EN0438	R CARBON 1/4W/M(T) 5% 4.7	FA270479
R953	79EN0429	R CARBON 1/4W/M(T) 5% 12	FA270120
R954	79PQ1859	CARBON 1/2W/M(T) 5% 68H	FA360680
R960	79EN0777	R METAL 1/4W 51KF(T)	FJ275102
R961	79EN0777	R METAL 1/4W 51KF(T)	FJ275102
R962	79EN0778	R METAL 1/4W 68KF(T)	FJ276802
R963	79PQ1861	METAL 1/4W/M(T) 1% 1K	FB271001
R964	79PQ1852	CARBON 1/2W/M(T) 5% 180K	FA360184
R965	79PQ1899	CHIP 1/8W(T) 5% 4.7K	FM100472
R966	79PQ1861	METAL 1/4W/M(T) 1% 1K	FB271001
R967	79PQ1892	CHIP 1/8W(T) 5% 1K	FM100102
R968	79EN0439	R CARBON 1/4W/M(T) 5% 82K	FA270823
R969	79PQ1901	CHIP 1/8W(T) 5% 8.2K	FM100822
R970	79EN0223	R SMD 1/8W(T) 5% 12K	FM100123
R971	79PQ1893	CHIP 1/8W(T) 5% 10K	FM100103
R972	79PQ1899	CHIP 1/8W(T) 5% 4.7K	FM100472
R973	79PQ1899	CHIP 1/8W(T) 5% 4.7K	FM100472
R974	79PQ2009	CARBON 1/4W/M(T) 5% 47H	FA270470

ALL PARTS LIST

MODEL: Diamond Pro 2070SB-BK(R)

LOCATION	PART No.	DESCRIPTION/SPECIFICATION	
R975	79PQ1828	CARBON 1/4W/M(T) 5% 1K	FA270102
R976	79EN0466	R METAL 1/4W/M(T) 1% 9.1K	FB279101
R977	79PQ1965	METAL 1/4W/M(T) 1% 1.5K	FB271501
R978	79PQ1862	METAL 1/4W/M(T) 1% 10K	FB271002
R979	79PQ1828	CARBON 1/4W/M(T) 5% 1K	FA270102
R980	79PQ1892	CHIP 1/8W(T) 5% 1K	FM100102
R984	79PQ1062	MOF 1W/M(B) 5% 100H	FB480101
R985	79PQ1865	METAL 1/4W/M(T) 1% 2K	FB272001
R989	79PQ2003	CARBON 1/4W/M(T) 5% 10K	FA270103
R990	79PQ1828	CARBON 1/4W/M(T) 5% 1K	FA270102
R991	79PQ2003	CARBON 1/4W/M(T) 5% 10K	FA270103
R993	79PQ1827	CARBON 1/4W/M(T) 5% 100H	FA270101
R996	79EN0149	R MOF 1W/M(B) 5% 2.2	FB480229
R997	79EN0442	R CARBON 1/2W/M(T) 5% 27K	FA360273
R998	79PQ1828	CARBON 1/4W/M(T) 5% 1K	FA270102
R999	79PQ1893	CHIP 1/8W(T) 5% 10K	FM100103
<b>***SWITCH***</b>			
SW101	79PQ0028	TACT SW 1P 100G+50	80000251
SW102	79PQ0028	TACT SW 1P 100G+50	80000251
SW103	79PQ0028	TACT SW 1P 100G+50	80000251
SW104	79PQ0028	TACT SW 1P 100G+50	80000251
SW105	79PQ0028	TACT SW 1P 100G+50	80000251
SW106	79PQ0028	TACT SW 1P 100G+50	80000251
SW107	79PQ0028	TACT SW 1P 100G+50	80000251
SW9A0	79PQ0974	POWER SW ESB92S21B TV5	80002021
<b>***TRANS***</b>			
T501	79EN0244	TRANS H-DRIVE EE2519	80019151
T550	79EN0373	H.OUT X'FM 0133016700 NSV	80014951
T5C0	79EN0243	TRANS CURRENT 16LAZA	80018961
T701	79PQ5497	FBT MSU1FVH216	HH240011
T7A1	79EN0063	TRANS DBF 80019751	80019751
T901	79EN0016	TRANS POWER EER40(CLOVER)	80017681
T902	79EN0044	TRANS POWER-SUB EER22	80018811
<b>***THERMISTOR***</b>			
TH100	79EN0363	TH NRD3103K400K03FMT	80014781
TH901	79EN0050	THERMISTOR SCK15105LI	80019281
TH902	79EN0364	TH PTC PTH451A4R5Q23	80014791
<b>***CRT***</b>			
X3A02	3A302204	CRT M51LVT42X MITSUBISHI	CP251P048A10
<b>***ASSY PCBs***</b>			
X04	7A940491	MAIN PWB ASSY(C22BW711)	
X05	7A940511	POWER PWB ASSY(C22BW711)	
X06	7A940501	MIXSUB PWB ASSY(C22BW711)	
<b>***OTHERS(ELECTRICAL COMPONENTS)***</b>			
RL901	79EN0367	RELAY G5PA-2DC12/ALA2PF12	80014891
VR5A1	79EN0772	VR CARBON 6MM 3K B	FF310302
X100	79PQ1824	X'TAL 49U 20MHZ +/-30PPM	EM020004
X1A0	79EN0072	X'TAL 49U-S 6MHZ +/-30PPM	EM260003
C1B4	79PQ5456	VARISTOR-CP 2012SGXA-TR1	80019971
C1B5	79EN0245	VARISTOR-CP 2012SGXA-TR1	80019971
C1C1	79EN0245	VARISTOR-CP 2012SGXA-TR1	80019971
C1C2	79EN0245	VARISTOR-CP 2012SGXA-TR1	80019971
C1C5	79EN0245	VARISTOR-CP 2012SGXA-TR1	80019971
C1C6	79EN0245	VARISTOR-CP 2012SGXA-TR1	80019971
C1E3	79EN0245	VARISTOR-CP 2012SGXA-TR1	80019971
C1E4	79EN0245	VARISTOR-CP 2012SGXA-TR1	80019971
SG200B	79PQ5603	SPARK GAP DSP-301N-C04F	80015191
SG200G	79PQ5603	SPARK GAP DSP-301N-C04F	80015191
SG200R	79PQ5603	SPARK GAP DSP-301N-C04F	80015191
<b>***COSMETIC PARTS***</b>			
X3201	25327161	BACK-COVER-UNIT,DARK,ROOF	CP721B062A40
X3202	25326811	REAR-PANEL,DARK,ROOF,GRAY	CP702A026A20
X3203	25327131	OUTER-BEZEL-UNIT	
X3204	25326771	T/S-STAND-UNIT,DARK,ROOF	CP722B029A20
X3205	25326791	INNER-BEZEL-UNIT,DARK,ABS	CP720B113A20
<b>***OTHERS***</b>			
SG205S	79PQ1164	SPAKER GAP 1.5KV	80002201
SG701	79EN0379	SPARK GAP DSP-201M-A21F	80015181
X2801	25284821	LEAD-CLAMPER,NYLON6	QX540D036B10
X2801	25285191	BAND-RIVET,NAD-06	CP540D023A30
X2801	25285221	CLAMPER,FCR-45,V0	CP540D076A10
X2802	25284831	LEAD-CLAMPER,NYLON6	QX540D085B10
X2802	25285031	LEAD-CLAMPER,636	CP540D050A20
X2803	25284821	LEAD-CLAMPER,NYLON6	QX540D036B10



ALL PARTS LIST

MODEL: Diamond Pro 2070SB-BK(R)

LOCATION	PART No.	DESCRIPTION/SPECIFICATION	
X2803	25285211	LEAD-CLAMPER,WS-2NS	CP540D040A10
X2804	25285221	CLAMPER,FCR-45,V0	CP540D076A10
X2804	25285621	PIPE-CLAMP	
X4A01	4A910002	CPM TP-13000MZ2	CP338P013A20
X5501	25550011	SPRING,SUS304	CP570C010A10
X5501	25550881	EMS-TB,SECC-C	CP626A028A10
X5501	25550931	SHIELD-LEFT,A1100P-H24	CP580A122A10
X5501	25550942	SHIELD-TOP,A1100P-H24	CP580A121-10
X5502	25550891	EMS-S,SECC-C	CP626A029A10
X5502	25551011	HOLDER-TOP,SPTE	CP593C240A10
X5503	25550011	SPRING,SUS304	CP570C010A10
X5504	25550021	SPRING,SUS304	CP570C010A20
X6101	25619691	INSULATOR-TOP,FORMEX-18	CP223C084A10
X6101	25619791	BARRIER,N-7 T0.5	CP223D084A10
X7001	25703961	RATING-LABEL	
X7002	25703981	PRINTING-SPEC	
X7901	25794471	LABEL-CAUTION,WHT PAPER	CP850D268A30
X7901	25794671	LABEL-PROTECT,PET	CP850D295A10
X7901	25794981	SHIPPING-LABEL	
X7902	25794681	LABEL-PROTECT,PET	CP850D295A20
X7902	25794771	LABEL,YUPO T0.11	CP850C474A50
X7902	25794791	PROTECT-LABEL	CP850D295A30
X7903	25794781	LABEL,YUPO T0.11	CP850C474A60
X7904	25794641	LABEL-BLACK	CP850D294A10
X7A01	7A082012	PW CORD AUST 2.5M 3P GRY	CP242C291A10
X7A01	7A900001	SILICONE-GUM KE40RTV 150G	QX081X319B70
X7A02	7A390018	CABLE VIDEO GRY DSUB-DSUB	CP242C304A10
X7A02	7A900002	TAPE ACETATE 570F 3000X19	CP071P002A10
X7A03	7A392035	USB-CABLE	
X7A03	7A900003	WEDGE	CP641P001A10
X7A04	7A812451	ACCESSORY	
X7A04	7A900004	TAPE GLASS 0.18-25X80000	QX070W213A70
X7A05	7A860251	WARRANTY-SET	
X7A06	7A860261	WARRANTY-CARD	
X8401	25840621	CUSHION	CP803A114A10
X8401	25841011	PACKING-CASE	
X8402	25841111	PACKING-BAG	CP831D005A20
X8402	25841321	PACKING-BAG	
X8501	25853451	SCREW 5X20	CP669D080A10
X8501	25853801	SCREW-TB-SEMS 3X8	CP669D074A10
X8501	25853891	SCREW-TB-CAP 3X8	CP669D103A10
X8501	25853891	SCREW-TB-CAP 3X8	CP669D103A10
X8501	25853891	SCREW-TB-CAP 3X8	CP669D103A10
X8502	25853511	SCREW-TB 4X16	QX669D221A60
X8502	25853891	SCREW-TB-CAP 3X8	CP669D103A10
X8502	25854101	SCREW-TB 4X12	QX669D221A40
X8503	25853421	SCREW-TB-BIND-W 3X8	CP669D016A20
X8505	25854141	SCREW-SEMS-W M4X0.7-8	RX669D171A50
X8506	25853801	SCREW-TB-SEMS 3X8	CP669D074A10
X9D01	25619971	TAPE	
X9D01	9D010001	SILICONE G KW-4890W 330ML	CP081X004A10
X9D01	9D030006	TAPE AL CCJ-36-201-W20MM	CP096P012A10
X9D01	9D030018	TAPE CARTON 75*500M	QX096Z466A90
X9D01	9D030021	TAPE-AL ETA-100 20X32.9M	
X9D01	9D040001	GROUND-LABEL	
X9D01	9D050001	LOCK-PEINT ACRIC1000 481	CP080P004A10
X9D02	9D010007	BOND HOT MELT MP786	CP096P006A10
X9D02	9D010008	SILICONE GU KE-4890W 140G	CP081X001A10
X9D02	9D050002	RIBBON-B110CX(W=90MM)	
X9D02	9D050003	RIBBON-B110CX(W=60MM)	
X9D03	9D030015	TAPE MASKIN NO.7290 CREAM	CP096P004A10